

# Flat suction cup (oval)

<https://www.schmalz.com/10.01.05.00563>



## SAOF 60x23 NBR-45 RA

Part no.: 10.01.05.00563

Homepage > Vacuum Technology for Automation > Vacuum Components > Vacuum Suction Cups > Flat Suction Cups (Oval) > Flat Suction Cups  
SAOF (Oval) > SAOF 60x23 NBR-45 RA

### Flat suction cup (oval) for very dynamic handling of smooth and oily workpieces



Dimensions (LxB): 60 x 23 mm

Suction cup material:

Nitrile rubber NBR

Material hardness: 45 °Sh

Nipple material: Aluminium

Vacuum connection:

Rectangular adapter

#### Design Data

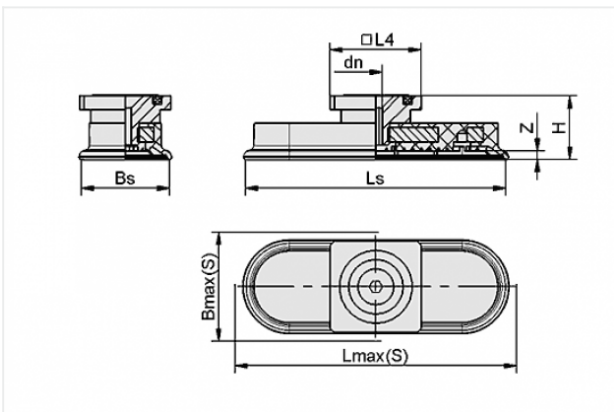

Attribute	Value
-----------	-------

Bmax(S)	25 mm
---------	-------

Bs	21.6 mm
----	---------

dn	4 mm
----	------

H	21 mm
---	-------

L4	32 mm
----	-------

Lmax(S)	64 mm
---------	-------

Ls	60.6 mm
----	---------

Z	3 mm
---	------

#### Technical Data

#### Contact to Schmalz

J. Schmalz GmbH | Johannes-Schmalz-Straße, 72293 Glatten, Deutschland | +49 7443 2403-102 |  
customercenter@schmalz.de

Attribute	Value
Suction force	57 N
Lateral force	37 N
Lateral force (oily surface)	33 N
Volume	3.89 cm <sup>3</sup>
Curve radius (min) (convex)	20 mm
Internal hose diameter (recom.)	4 mm
Dimensions (LxB)	60 x 23 mm
Number of folds	0
Suction cup material	Nitrile rubber NBR
Material hardness	45 °Sh
Weight	31 g
Product family	SAOF

**Note:**

- Suction force: The specified suction forces are theoretical values at a vacuum of -0.6 bar and with a smooth, dry workpiece surface - they do not include a safety factor
- Lateral force: The specified lateral forces are values measured at a vacuum of -0.6 bar with a dry or oily, smooth, flat workpiece surface. Depending on the workpiece surface and its quality, the actual values may deviate from these values
- Hose diameter: The recommended hose diameter refers to a hose length of approx. 2 m