

Flat suction cup (oval)

SAOF 60x23 NBR-60 G3/8-IG

<https://www.schmalz.com/10.01.05.00370>



Part no.: 10.01.05.00370

Homepage > Vacuum Technology for Automation > Vacuum Components > Vacuum Suction Cups > Suction Cups for Handling Sheet Metal > Flat Suction Cups SAOF (Oval) > SAOF 60x23 NBR-60 G3/8-IG

Flat suction cup (oval) for very dynamic handling of smooth and oily workpieces



Dimensions (LxB): 60 x 23 mm

Suction cup material:

Nitrile rubber NBR

Material hardness: 60 °Sh

Nipple material: Brass, nickel-plated

Vacuum connection: G3/8-F

Design Data

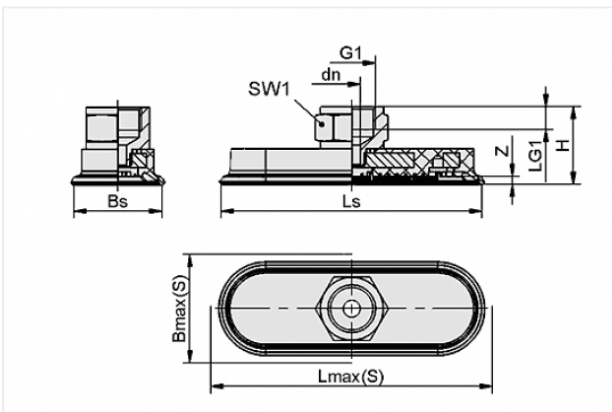

Attribute	Value
-----------	-------

Bmax(S)	25 mm
---------	-------

Bs	21.6 mm
----	---------

dn	6 mm
----	------

G1	G3/8"-F
----	---------

H	26 mm
---	-------

LG1	9 mm
-----	------

Lmax(S)	64 mm
---------	-------

Ls	60.6 mm
----	---------

SW1	22 mm
-----	-------

Z	3 mm
---	------

Contact to Schmalz

J. Schmalz GmbH | Johannes-Schmalz-Straße, 72293 Glatten, Deutschland | +49 7443 2403-102 | customercenter@schmalz.de

Technical Data

Attribute	Value
Suction force	57 N
Lateral force	37 N
Lateral force (oily surface)	33 N
Volume	3.89 cm ³
Curve radius (min) (convex)	20 mm
Internal hose diameter (recom.)	4 mm
Dimensions (LxB)	60 x 23 mm
Number of folds	0
Suction cup material	Nitrile rubber NBR
Material hardness	60 °Sh
Weight	42 g
Product family	SAOF

Note:

- Suction force: The specified suction forces are theoretical values at a vacuum of -0.6 bar and with a smooth, dry workpiece surface - they do not include a safety factor
- Lateral force: The specified lateral forces are values measured at a vacuum of -0.6 bar with a dry or oily, smooth, flat workpiece surface. Depending on the workpiece surface and its quality, the actual values may deviate from these values
- Hose diameter: The recommended hose diameter refers to a hose length of approx. 2 m