

Flat suction cup (round)

<https://www.schmalz.com/10.01.01.11043>



PFYN-F 30 CR-50 G1/8-AG
M5-IG

Part no.: 10.01.01.11043

Homepage > Vacuum Technology for Automation > Vacuum Components > Vacuum Suction Cups > Flat Suction Cups (Round) > Flat Suction Cups

PFYN-F > PFYN-F 30 CR-50 G1/8-AG M5-IG

Flat suction cup (round)



Size: 30

Suction cup material: Chloroprene CR

Material hardness: 50 °Sh

Vacuum connection: G1/8-M

alt. Vacuum connection: M5-F

Design Data

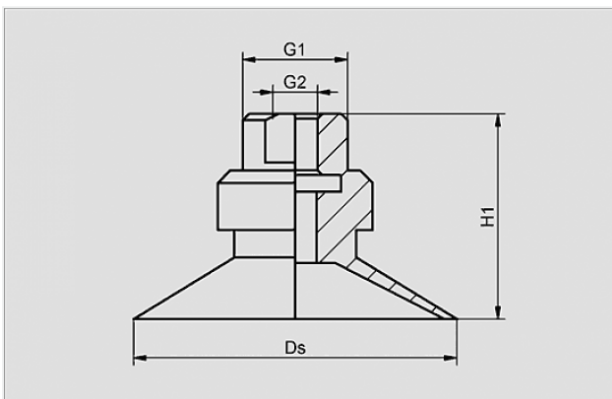

Attribute	Value
-----------	-------

Ds	30 mm
----	-------

G2	M5-F
----	------

H1	19 mm
----	-------

Technical Data

Attribute	Value
-----------	-------

Weight	5.1 g
--------	-------

Suction cup material	Chloroprene CR
----------------------	----------------

Number of folds	0
-----------------	---

Contact to Schmalz

J. Schmalz GmbH | Johannes-Schmalz-Straße, 72293 Glatten, Deutschland | +49 7443 2403-102 | customercenter@schmalz.de

Spare Parts



SA-NIP G1/8-AG

Part no. 10.01.01.10934

Suction cup connection nipple

Thread G1: G1/8-M

Fitting length: 14.5 mm

Material: Aluminium



PFG-F 30 CR-50

Part no. 10.01.01.11022

Flat suction cup (round)

Size: 30

Suction cup material: Chloroprene CR

Material hardness: 50 °Sh