

Protection Cover PC 125

<https://www.schmalz.com/10.01.01.13086>



Part no.: 10.01.01.13086

Homepage > Vacuum Technology for Automation > Vacuum Components > Vacuum Suction Cups > Accessories Vacuum Suction Cups >

Protection Covers PC > PC 125

Cover for suction cup



Size: 125

Design Data

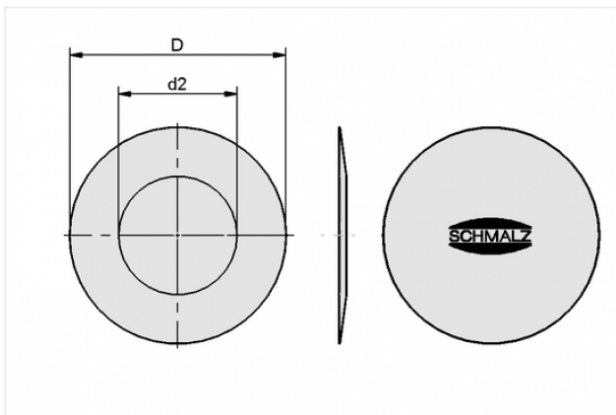

Attribute	Value
d2	65 mm
D	125 mm

Technical Data

Attribute	Value
Size	125
Weight	8.1 g

Contact to Schmalz

J. Schmalz GmbH | Johannes-Schmalz-Straße, 72293 Glatten, Deutschland | +49 7443 2403-102 | customercenter@schmalz.de

Note:

- Suction pad protection covers PC are designed for the use with suction pads and suction plates that are out of use. They cannot be used during handling.
