

Flat suction cup (round)

<https://www.schmalz.com/10.01.01.12225>



SHFN 85 NK-45 G1/4-AG E MOS-TV

Part no.: 10.01.01.12225

Homepage > Vacuum Technology for Automation > Vacuum Components > Vacuum Suction Cups > Suction Cups for Handling Wood > Flat

Suction Cups SHFN > SHFN 85 NK-45 G1/4-AG E MOS-TV

Flat suction cup (round) for highly dynamic handling of wood



Size: 85
Suction cup material:
Natural Rubber NK
Material hardness: 45 °Sh
Vacuum connection: G1/4-M
Type: E
Additional feature:
Sealing lip with sensing valve

Design Data

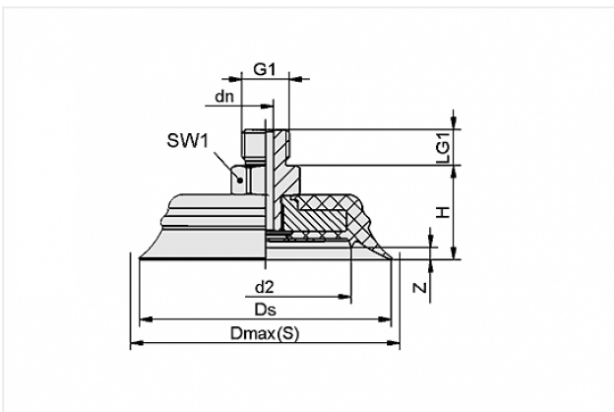

Attribute	Value
-----------	-------

dn	4.4 mm
----	--------

Dmax(S)	89 mm
---------	-------

Ds	85 mm
----	-------

G1	G1/4"-M
----	---------

H	33.4 mm
---	---------

LG1	10 mm
-----	-------

SW1	17 mm
-----	-------

Z	4 mm
---	------

d2	50 mm
----	-------

Contact to Schmalz

J. Schmalz GmbH | Johannes-Schmalz-Straße, 72293 Glatten, Deutschland | +49 7443 2403-102 | customercenter@schmalz.de

Technical Data

Attribute	Value
Size	85
Suction cup material	Natural Rubber NK
Suction force d2	175 N
Suction force	300 N
Lateral force	210 N
Volume	25 cm ³
Curve radius (min) (convex)	176 mm
Internal hose diameter (recom.)	6 mm
Number of folds	0
Weight	98 g
Product family	SHFN

Note:

- Suction force: The specified suction forces are theoretical values at a vacuum of -0.6 bar and with a smooth, dry workpiece surface - they do not include a safety factor
- Pull-off force: The pull-off force of the versions made of natural rubber is reduced by about 40%
- Hose diameter: The recommended hose diameter refers to a hose length of approx. 2 m

Spare Parts

Contact to Schmalz

**TVN G1/4-AG 9 N009**

Part no. 10.05.10.00065

Connection nipple with integrated touch valve

Thread G1: G1/4-M

Thread G2: M10x1.25-M

Spring stroke Z: 9 mm

Nipple: N 009

**SHF 85 NK-45 M10x1.25-IG E MOS**

Part no. 10.01.01.12223

Flat suction cup (round) for highly dynamic handling of wood

Size: 85

Suction cup material:

Natural Rubber NK

Connection thread: M10x1.25-F

Material hardness: 45 °Sh

Type: E

Additional feature:

Sealing lip with MOS

**DR 60/50x5 S05 EPDM-15 KE**

Part no. 10.01.06.01720

Gasket made from special foam for optimal sealing of structured surfaces

External diameter D: 60 mm

Internal diameter d: 50 mm

Height H: 5 mm

Material-Type: Foam S, Height 5 mm

Sealing material: EPDM

Material hardness: 15 °Sh

with: Tape on one side

Accessories**Contact to Schmalz**

J. Schmalz GmbH | Johannes-Schmalz-Straße, 72293 Glatten, Deutschland | +49 7443 2403-102 |
customercenter@schmalz.de



SIEB 14.5x1 MS-A2 0.103/0.15

Part no. 10.05.03.00023

Screen

External diameter D: 14.5 mm

Length L: 1 mm

Material: Brass / Stainless steel

Mesh: 0.103 mm

Wire size: 0.15 mm