

Flat suction cup (round)

<https://www.schmalz.com/10.01.01.11779>



SHFN 85 NK-45 G1/4-AG TV

Part no.: 10.01.01.11779

Homepage > Vacuum Technology for Automation > Vacuum Components > Vacuum Suction Cups > Suction Cups for Handling Wood > Flat Suction Cups SHFN > SHFN 85 NK-45 G1/4-AG TV

Flat suction cup (round) for highly dynamic handling of wood



Size: 85
Suction cup material:
Natural Rubber NK
Material hardness: 45 °Sh
Nipple material: Aluminium
Vacuum connection: G1/4-M
Additional feature: Sensing valve

Design Data

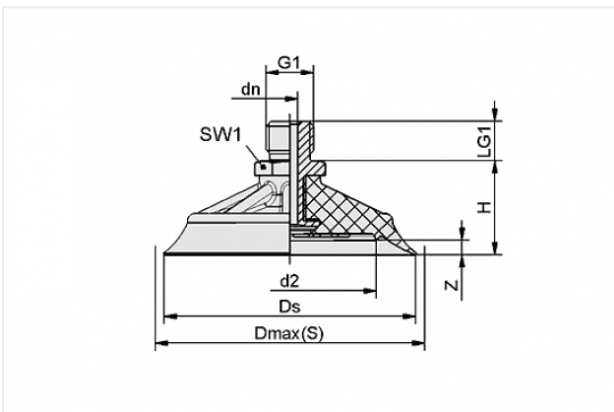

Attribute	Value
dn	4.4 mm
Dmax(S)	89 mm
Ds	85 mm
G1	G1/4"-M
H	32.2 mm
LG1	11 mm
SW1	17 mm
Z	4 mm
d2	62 mm

Contact to Schmalz

J. Schmalz GmbH | Johannes-Schmalz-Straße, 72293 Glatten, Deutschland | +49 7443 2403-102 | customercenter@schmalz.de

Technical Data

Attribute	Value
Size	85
Suction cup material	Natural Rubber NK
Suction force d2	175 N
Suction force	300 N
Lateral force	210 N
Volume	25 cm ³
Curve radius (min) (convex)	176 mm
Internal hose diameter (recom.)	6 mm
Number of folds	0
Weight	52.8 g
Product family	SHFN

Note:

- Suction force: The specified suction forces are theoretical values at a vacuum of -0.6 bar and with a smooth, dry workpiece surface - they do not include a safety factor
- Pull-off force: The pull-off force of the versions made of natural rubber is reduced by about 40%
- Hose diameter: The recommended hose diameter refers to a hose length of approx. 2 m

Spare Parts

Contact to Schmalz



TVN G1/4-AG 8.4 N041

Part no. 10.05.10.00058

Connection nipple with integrated touch valve

Thread G1: G1/4-M

Spring stroke Z: 8.4 mm

Nipple: N 041



SHF 85 NK-45 N041

Part no. 10.01.01.11773

Flat suction cup (round) for highly dynamic handling of wood

Size: 85

Suction cup material:

Natural Rubber NK

Material hardness: 45 °Sh

Accessories



SIEB 15x0.8 MS-A2 0.103/0.07

Part no. 10.07.01.00211

Screen

External diameter D: 15 mm

Length L: 0.8 mm

Material: Brass / Stainless steel

Mesh: 0.103 mm

Wire size: 0.07 mm