

Flat suction cup (round)

<https://www.schmalz.com/10.01.01.11691>



SHFN 70 NK-45 G1/4-AG MOS

Part no.: 10.01.01.11691

Homepage > Vacuum Technology for Automation > Vacuum Components > Vacuum Suction Cups > Suction Cups for Handling Wood > Flat

Suction Cups SHFN > SHFN 70 NK-45 G1/4-AG MOS

Flat suction cup (round) for highly dynamic handling of wood



Size: 70

Suction cup material:

Natural Rubber NK

Material hardness: 45 °Sh

Nipple material: Aluminium

Vacuum connection: G1/4-M

Additional feature:

Sealing lip with MOS

Design Data

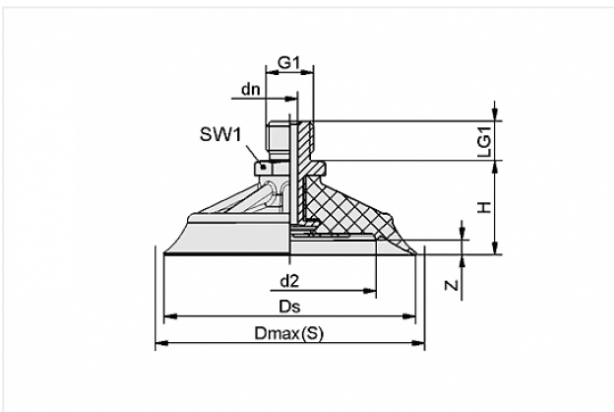

Attribute	Value
-----------	-------

dn	4.4 mm
----	--------

Dmax(S)	74 mm
---------	-------

Ds	70 mm
----	-------

G1	G1/4"-M
----	---------

H	26.2 mm
---	---------

LG1	11 mm
-----	-------

SW1	17 mm
-----	-------

Z	4 mm
---	------

d2	36 mm
----	-------

Contact to Schmalz

J. Schmalz GmbH | Johannes-Schmalz-Straße, 72293 Glatten, Deutschland | +49 7443 2403-102 | customercenter@schmalz.de

Technical Data

Attribute	Value
Size	70
Suction cup material	Natural Rubber NK
Suction force d2	100 N
Suction force	200 N
Lateral force	145 N
Volume	12.8 cm ³
Curve radius (min) (convex)	95 mm
Internal hose diameter (recom.)	6 mm
Number of folds	0
Weight	31.5 g
Product family	SHFN

Note:

- Suction force: The specified suction forces are theoretical values at a vacuum of -0.6 bar and with a smooth, dry workpiece surface - they do not include a safety factor
- Pull-off force: The pull-off force of the versions made of natural rubber is reduced by about 40%
- Hose diameter: The recommended hose diameter refers to a hose length of approx. 2 m

Spare Parts

Contact to Schmalz



SA-NIP N041 G1/4-AG DN440

Part no. 10.01.01.11772

Suction cup connection nipple

Nipple: N 041

Thread G1: G1/4-M

Overall length: 29.3 mm

Fitting length: 4 mm

Nominal size: 4,40 mm

Material: Aluminium

Spanner size SW2: 5 mm



SIEB 15x0.8 MS-A2 0.103/0.07

Part no. 10.07.01.00211

Screen

External diameter D: 15 mm

Length L: 0.8 mm

Material: Brass / Stainless steel

Mesh: 0.103 mm

Wire size: 0.07 mm



SHF 70 NK-45 N041 MOS

Part no. 10.01.01.11686

Flat suction cup (round) for highly dynamic handling of wood

Size: 70

Suction cup material:

Natural Rubber NK

Material hardness: 45 °Sh

Additional feature:

Sealing lip with MOS

**DR 46/36x5 S05 EPDM-15 KE**

Part no. 10.01.06.01678

Gasket made from special foam for optimal sealing of structured surfaces

External diameter D: 46 mm

Internal diameter d: 36 mm

Height H: 5 mm

Material-Type: Foam S, Height 5 mm

Sealing material: EPDM

Material hardness: 15 °Sh

with: Tape on one side

Accessories**SIEB 15x0.8 MS-A2 0.103/0.07**

Part no. 10.07.01.00211

Screen

External diameter D: 15 mm

Length L: 0.8 mm

Material: Brass / Stainless steel

Mesh: 0.103 mm

Wire size: 0.07 mm