

Flat suction cup (round)

<https://www.schmalz.com/10.01.01.11687>



SHF 50 NK-45 N041

Part no.: 10.01.01.11687

Homepage > Vacuum Technology for Automation > Vacuum Components > Vacuum Suction Cups > Suction Cups for Handling Wood > SHF 50 NK-45 N041

Flat suction cup (round) for highly dynamic handling of wood



Size: 50
Suction cup material:
Natural Rubber NK
Material hardness: 45 °Sh

Design Data

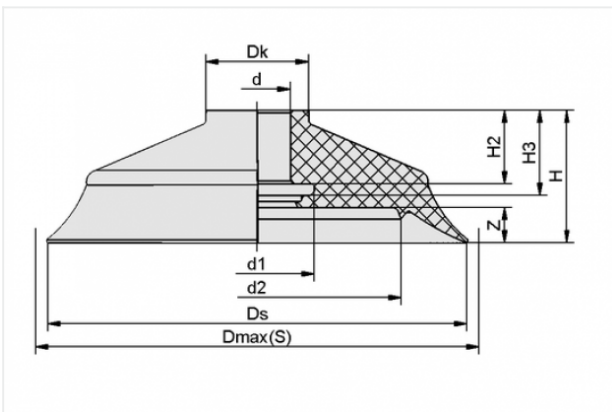

Attribute	Value
-----------	-------

d	7.5 mm
---	--------

d1	17 mm
----	-------

d2	30 mm
----	-------

Dk	17 mm
----	-------

Dmax(S)	55 mm
---------	-------

Ds	52 mm
----	-------

H	22.2 mm
---	---------

H2	12.8 mm
----	---------

H3	14.3 mm
----	---------

Z	3 mm
---	------

Contact to Schmalz

J. Schmalz GmbH | Johannes-Schmalz-Straße, 72293 Glatten, Deutschland | +49 7443 2403-102 | customercenter@schmalz.de

Technical Data

Attribute	Value
Suction force	90 N
Lateral force	95 N
Volume	8.05 cm ³
Curve radius (min) (convex)	41 mm
Size	50
Nipple	N 041
Suction cup material	Natural Rubber NK
Weight	15 g
Number of folds	0

Accessories



SA-NIP N041 G1/4-AG DN440

Part no. 10.01.01.11772

Suction cup connection nipple

Nipple: N 041

Thread G1: G1/4-M

Overall length: 29.3 mm

Fitting length: 4 mm

Nominal size: 4,40 mm

Material: Aluminium

Spanner size SW2: 5 mm



SA-NIP N041 G1/4-IG DN440

Part no. 10.01.01.11822

Suction cup connection nipple

Nipple: N 041

Thread G1: G1/4-F

Overall length: 29.3 mm

Fitting length: 15 mm

Nominal size: 4,40 mm

Material: Aluminium

Spanner size SW2: 5 mm



TVN G1/4-AG 8.4 N041

Part no. 10.05.10.00058

Connection nipple with integrated touch valve

Thread G1: G1/4-M

Spring stroke Z: 8.4 mm

Nipple: N 041



SIEB 15x0.8 MS-A2 0.103/0.07

Part no. 10.07.01.00211

Screen

External diameter D: 15 mm

Length L: 0.8 mm

Material: Brass / Stainless steel

Mesh: 0.103 mm

Wire size: 0.07 mm