

Flat suction cup (round)

<https://www.schmalz.com/10.01.01.11483>



SAF 125 NBR-45 RA

Part no.: 10.01.01.11483

Homepage > Vacuum Technology for Automation > Vacuum Components > Vacuum Suction Cups > Flat Suction Cups (Round) > Flat Suction Cups

SAF > SAF 125 NBR-45 RA

Flat suction cup (round) for very dynamic handling of smooth and oily workpieces



Size: 125
Suction cup material:
Nitrile rubber NBR
Material hardness: 45 °Sh
Vacuum connection:
Rectangular adapter
Nipple material: Aluminium

Design Data

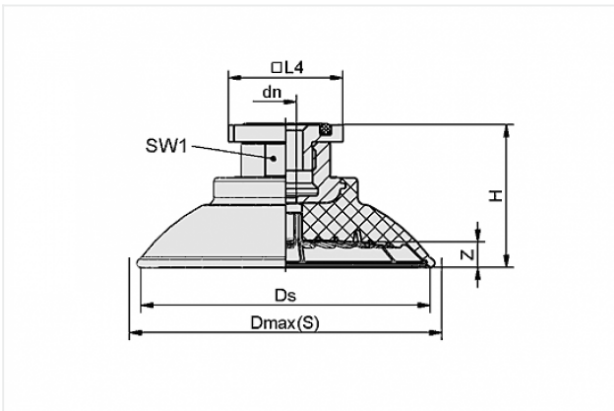

Attribute	Value
dn	9 mm
Dmax(S)	135 mm
Ds	125 mm
H	42.5 mm
SW1	22 mm
Z	12.5 mm

Technical Data

Attribute	Value
Suction force	660 N

Contact to Schmalz

J. Schmalz GmbH | Johannes-Schmalz-Straße, 72293 Glatten, Deutschland | +49 7443 2403-102 | customercenter@schmalz.de

Attribute	Value
Lateral force	475 N
Lateral force (oily surface)	400 N
Volume	119 cm ³
Curve radius (min) (convex)	165 mm
Internal hose diameter (recom.)	9 mm
Size	125
Suction cup material	Nitrile rubber NBR
Material hardness	45 °Sh
Weight	155.2 g
Number of folds	0
Product family	SAF

Note:

- Suction force: The specified suction forces are theoretical values at a vacuum of -0.6 bar and with a smooth, dry workpiece surface - they do not include a safety factor
- Lateral force: The specified lateral forces are values measured at a vacuum of -0.6 bar with a dry or oily, smooth, flat workpiece surface. Depending on the workpiece surface and its quality, the actual values may deviate from these values
- Hose diameter: The recommended hose diameter refers to a hose length of approx. 2 m

Accessories



SU 120

Part no. 10.01.01.12437

Cover for suction cup

Size: 120

Clamping range: 115.0 ... 130.0 mm

Temperature resistance: 80 °C

