

Flat suction cup (round)

<https://www.schmalz.com/10.01.01.10799>



SAF 60 NBR-60 RA

Part no.: 10.01.01.10799

Homepage > Vacuum Technology for Automation > Vacuum Components > Vacuum Suction Cups > Suction Cups for Handling Sheet Metal > Flat Suction Cups SAF > SAF 60 NBR-60 RA

Flat suction cup (round) for very dynamic handling of smooth and oily workpieces



Size: 60
Suction cup material:
Nitrile rubber NBR
Material hardness: 60 °Sh
Vacuum connection:
Rectangular adapter
Nipple material: Aluminium

Design Data

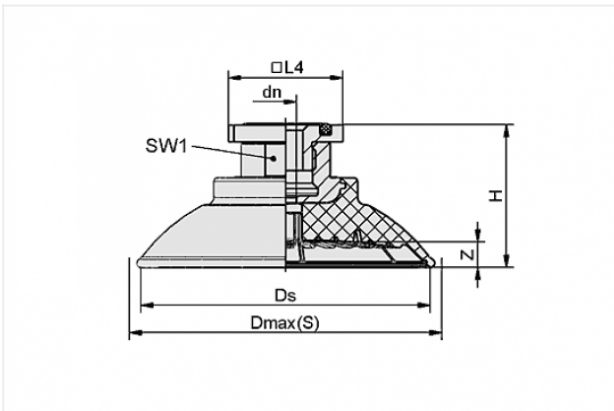

Attribute	Value
-----------	-------

dn	6 mm
----	------

Dmax(S)	67 mm
---------	-------

Ds	60.6 mm
----	---------

H	30.5 mm
---	---------

SW1	22 mm
-----	-------

Z	6 mm
---	------

Technical Data

Attribute	Value
-----------	-------

Suction force	150 N
---------------	-------

Contact to Schmalz

J. Schmalz GmbH | Johannes-Schmalz-Straße, 72293 Glatten, Deutschland | +49 7443 2403-102 | customercenter@schmalz.de

Attribute	Value
Lateral force	105 N
Lateral force (oily surface)	85 N
Volume	16.7 cm ³
Curve radius (min) (convex)	75 mm
Internal hose diameter (recom.)	6 mm
Size	60
Suction cup material	Nitrile rubber NBR
Material hardness	60 °Sh
Weight	46.5 g
Number of folds	0
Product family	SAF

Note:

- Suction force: The specified suction forces are theoretical values at a vacuum of -0.6 bar and with a smooth, dry workpiece surface - they do not include a safety factor
- Lateral force: The specified lateral forces are values measured at a vacuum of -0.6 bar with a dry or oily, smooth, flat workpiece surface. Depending on the workpiece surface and its quality, the actual values may deviate from these values
- Hose diameter: The recommended hose diameter refers to a hose length of approx. 2 m

Accessories



SU 60

Part no. 10.01.01.13585

Cover for suction cup

Size: 60

Temperature resistance: 80 °C

