

Flat suction cup (round)

<https://www.schmalz.com/10.01.01.11400>



SAF 30 NBR-45 G1/4-IG

Part no.: 10.01.01.11400

Homepage > Vacuum Technology for Automation > Vacuum Components > Vacuum Suction Cups > Suction Cups for Handling Sheet Metal > Flat Suction Cups SAF > SAF 30 NBR-45 G1/4-IG

Flat suction cup (round) for very dynamic handling of smooth and oily workpieces



Size: 30
Suction cup material:
Nitrile rubber NBR
Material hardness: 45 °Sh
Vacuum connection: G1/4-F
Nipple material: Aluminium

Design Data

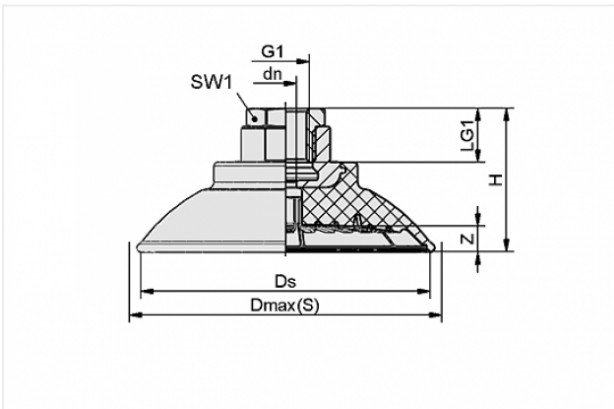

Attribute	Value
dn	4 mm
Dmax(S)	34 mm
Ds	31 mm
G1	G1/4"-F
H	20 mm
LG1	12 mm
SW1	17 mm
Z	3 mm

Technical Data

Contact to Schmalz

J. Schmalz GmbH | Johannes-Schmalz-Straße, 72293 Glatten, Deutschland | +49 7443 2403-102 | customercenter@schmalz.de

Attribute	Value
Suction force	38 N
Lateral force	30 N
Lateral force (oily surface)	28 N
Volume	2.72 cm ³
Curve radius (min) (convex)	40 mm
Internal hose diameter (recom.)	4 mm
Size	30
Suction cup material	Nitrile rubber NBR
Material hardness	45 °Sh
Weight	11.6 g
Number of folds	0
Product family	SAF

Note:

- Suction force: The specified suction forces are theoretical values at a vacuum of -0.6 bar and with a smooth, dry workpiece surface - they do not include a safety factor
- Lateral force: The specified lateral forces are values measured at a vacuum of -0.6 bar with a dry or oily, smooth, flat workpiece surface. Depending on the workpiece surface and its quality, the actual values may deviate from these values
- Hose diameter: The recommended hose diameter refers to a hose length of approx. 2 m

Accessories



SU 30

Part no. 10.01.01.12889

Cover for suction cup

Size: 30

Clamping range: 27.0 ... 35.0 mm

Temperature resistance: 80 °C

