

Sealing ring for SPU suction plate

<https://www.schmalz.com/10.01.01.01095>



DR-SPU 250 SI-55

Part no.: 10.01.01.01095

Homepage > Vacuum Technology for Automation > Vacuum Components > Vacuum Suction Cups > Flat Suction Cups (Round) > DR-SPU 250

SI-55

Sealing ring for suction plate SPU



Size: 250
Suction cup material: Silicone SI
Material hardness: 55 °Sh

Design Data

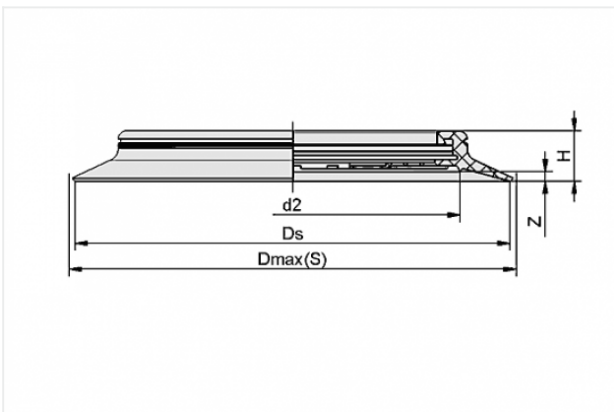

Attribute	Value
-----------	-------

d2	199.2 mm
----	----------

Ds	250 mm
----	--------

Dmax(S)	252.4 mm
---------	----------

H	24.5 mm
---	---------

Z	4.5 mm
---	--------

Technical Data

Attribute	Value
Size	250
Material hardness	55 °Sh

Contact to Schmalz

J. Schmalz GmbH | Johannes-Schmalz-Straße, 72293 Glatten, Deutschland | +49 7443 2403-102 | customercenter@schmalz.de



Attribute	Value
Suction cup material	Silicone SI
Weight	277 g
