

Bellows suction cups (round)

PSPF 33 SI-30/55 G3/8-IG

Part no...:10.01.06.05592

<https://www.schmalz.com/10.01.06.05592>

Home > Vacuum Technology for Automation > Vacuum Components > Vacuum Suction Cups > Suction Cups for the Packaging Industry > Bellows Suction Cups PSPF > PSPF 33 SI-30/55 G3/8-IG

2K bellow suction cup (round) for thin, unstable and liquid-filled pouch packages



Size: 33

Suction cup material: Silicone SI

Material hardness [Shore A]: 30 Shore A

Material hardness: 55 Shore A

Vacuum connection: G3/8"-F

Number of folds: 3.5

Design Data

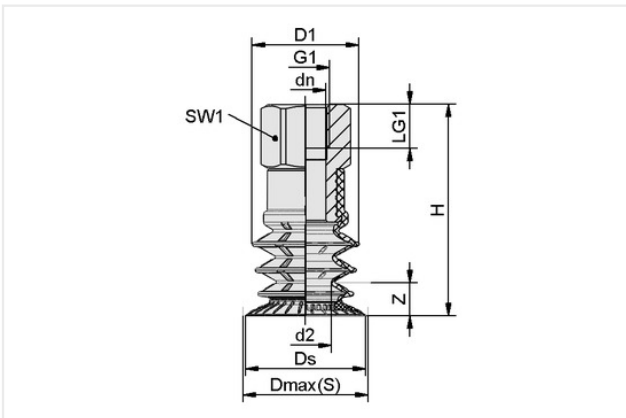

Attribute	Value
Z (Stroke)	14.50 mm
d2	14 mm
dn	11 mm
Dmax(S)	33.50 mm
Ds	33 mm
G1	G3/8"-F
G1	G3/8-IG
H	57.50 mm
LG1	12 mm
SW1	22 mm

Technical Data

Attribute	Value
Number of folds	3.50
Size	33
Suction cup material	Silicone SI
Suction force (-600mbar)	24 N
Product family	PSPF

Bellows suction cups (round)

PSPF 33 SI-30/55 G3/8-IG

Part no.:10.01.06.05592

<https://www.schmalz.com/10.01.06.05592>

Spare parts



PSPF 33 SI-30/55 SC080

Part no.:10.01.06.05502

Size: 33

Suction cup material: Silicone SI

Material hardness [Shore A]: 30 Shore A

Material hardness: 55 Shore A

Material characteristics: FDA-compatible

Number of folds: 3.5



SC 080 G3/8-IG

Part no.:10.01.06.02594

Connection geometry: 080

Vacuum connection: G3/8"-F

Length L1: 32 mm

Fitting length: 17.5 mm

Nominal diameter dn: 11 mm