

Vacuum block

VCBL-S6-CUP 120x50x85 TV

Part no...:10.01.12.04626

<https://www.schmalz.com/10.01.12.04626>

Home > Vacuum Clamping Technology > Clamping Equipment for Woodworking > Clamping Equipment for Systems from SCM / Morbidelli > Vacuum Blocks VCBL-S6 > VCBL-S6-CUP 120x50x85 TV

Vacuum block for SCM/Morbidelli console - Type 6



Dimensions (LxB): 120x50

Height H: 85 mm

Add. function: Sensing valve

Design Data

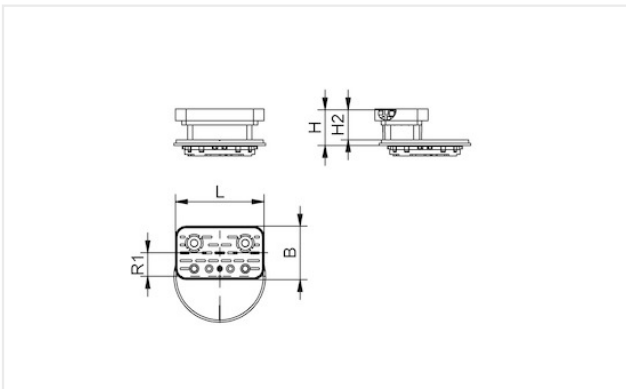

Attribute	Value
B	50 mm
B1	129 mm
H	85 mm
H1	99.50 mm
H2	77 mm
L	120 mm
L1	137 mm
R1	480 mm

Spare parts

Contact Schmalz

J. Schmalz GmbH | Johannes-Schmalz-Str.1, D-72293 Glatten | +49 7443 2403-102 | customercenter@schmalz.de

Vacuum block

VCBL-S6-CUP 120x50x85 TV

Part no...:10.01.12.04626

<https://www.schmalz.com/10.01.12.04626>



VCSP-O 120x50x15.5

Part no...:10.01.12.00012

Dimensions (LxB): mm

Length L: 120 mm

Width B: 50 mm

Height H: 15.5 mm



TV D9 4.3

Part no...:10.01.12.02514

External diameter D: 9 mm

Spring stroke Z: 4.3 mm

Length L: 23.8 mm