

Vacuum block

VCBL-S6 130x30x50 S-360-15 TV

Part no...:10.01.12.04463

<https://www.schmalz.com/10.01.12.04463>

Home > Vacuum Clamping Technology > Clamping Equipment for Woodworking > Clamping Equipment for Systems from SCM / Morbidelli > Vacuum Blocks VCBL-S6 > VCBL-S6 130x30x50 S-360-15 TV

Vacuum block for SCM/Morbidelli console - Type 6



Dimensions (LxB): 130x30

Height H: 50 mm

Arrangement: insertable 360°/15°

Add. function: Sensing valve

Design Data

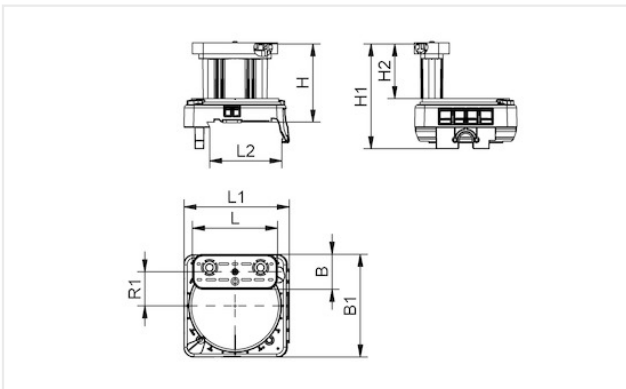

Attribute	Value
B	30 mm
B1	144 mm
H	50 mm
H1	87.50 mm
H2	17 mm
L	130 mm
L1	148.50 mm
L2	104 mm
R1	550 mm

Accessories

Contact Schmalz

J. Schmalz GmbH | Johannes-Schmalz-Str.1, D-72293 Glatten | +49 7443 2403-102 | customercenter@schmalz.de

Vacuum block

VCBL-S6 130x30x50 S-360-15 TV

Part no...:10.01.12.04463

<https://www.schmalz.com/10.01.12.04463>



SCHA-NOCK 12x8x21.8 VCBL-S6

Part no...:10.01.12.04741

Length L: 12 mm

Width B: 8 mm

Height H: 21.8 mm

Construction use: VCBL-S6

Spare parts



VST VCSP

Part no...:10.01.12.01543

Construction use: Vacuum block suction plate

Dimensions (LxB): mm



VCDR 135x25.5x6 VCBL

Part no...:10.01.12.04560

Length L: 135 mm

Width B: 25.5 mm

Height H: 6 mm

Construction use: Vacuum block

Vacuum block

VCBL-S6 130x30x50 S-360-15 TV

Part no...:10.01.12.04463

<https://www.schmalz.com/10.01.12.04463>



TV D9 4.3

Part no...:10.01.12.02514

External diameter D: 9 mm

Spring stroke Z: 4.3 mm

Length L: 23.8 mm



ZUB VCBL-S6

Part no...:10.01.12.04814

Construction use: VCBL-S6