

Vacuum block

VCBL-S6-CUP 125x75x50 TV+ME

Part no...:10.01.12.04628

<https://www.schmalz.com/10.01.12.04628>

Home > Vacuum Clamping Technology > Clamping Equipment for Woodworking > Clamping Equipment for Systems from SCM / Morbidelli > Vacuum Blocks VCBL-S6 > VCBL-S6-CUP 125x75x50 TV+ME

Vacuum block for SCM/Morbidelli console - Type 6



Dimensions (LxB): 125x75

Height H: 50 mm

Design Data

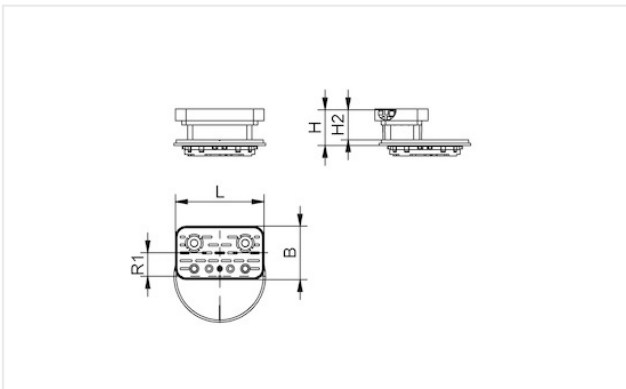

Attribute	Value
B	75 mm
B1	129 mm
H	50 mm
H1	64.50 mm
H2	42 mm
L	125 mm
L1	135 mm
R1	330 mm

Accessories

Contact Schmalz

J. Schmalz GmbH | Johannes-Schmalz-Str.1, D-72293 Glatten | +49 7443 2403-102 | customercenter@schmalz.de

Vacuum block

VCBL-S6-CUP 125x75x50 TV+ME

Part no...:10.01.12.04628

<https://www.schmalz.com/10.01.12.04628>



VCSP-O 125x75x17.9 ME-MOS

Part no...:10.01.12.04836

Construction use: VCBL-S6

Dimensions (LxB): mm

Length L: 125 mm

Width B: 75 mm

Height H: 17.9 mm

Spare parts



VCSP-O 125x75x16.5 ME

Part no...:10.01.12.04766

Dimensions (LxB): mm

Length L: 125 mm

Width B: 75 mm

Height H: 16.5 mm

Add. function: Membrane



TV D9 4.3

Part no...:10.01.12.02514

External diameter D: 9 mm

Spring stroke Z: 4.3 mm

Length L: 23.8 mm