

SLIDING DOOR LATCH W/INSIDE INDICATOR



HC-65



Application Example

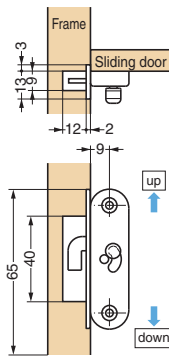

Features

- Ideal for harsh and high corrosion environments.
- Surface mount door latch with indicator.
- Non-Handed: Can be installed on left or right side.

Parts Included

- Raised countersunk head tapping screw 3x16 (SUS)
- Countersunk head tapping screw 3x16 (SUS)

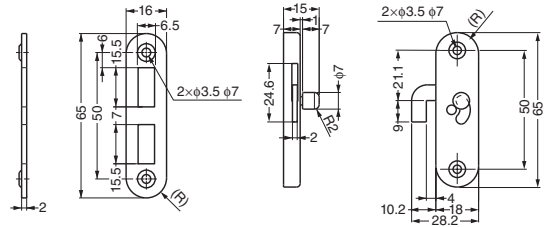

Item Code	Item Name	Material	Finish	Weight	Box	Carton
140-180-578	HC-65	Stainless Steel (SUS304)	Satin	41 g	20 pcs	200 pcs

SLIDING DOOR LOCK

SB, SBU



* Pearl Chrome (Pcr), Satin Gold (SG) can be produced as special order.

Item Code	Item Name	Type	Colour	Door Thickness	Back Set	Box
-	D238K-ZK-3SB (Cr/N)	Without Indicator	Chrome	36-40	38	30 pcs
-	D238K-ZK-4SB (Cr/N)	With Indicator		36-40		
-	D238K-ZK-5SB (Cr/N)	With Cylinder Lock		40		
-	D251K-ZK-3SB (Cr/N)	Without Indicator	Gold Nickel	36-40	51	
-	D251K-ZK-4SB (Cr/N)	With Indicator		36-40		
-	D251K-ZK-5SB (Cr/N)	With Cylinder Lock		40		

Item Code	Item Name	Type	Colour	Door Thickness	Back Set	Box
-	D238K-ZK-3SBU (Cr/N)	Without Indicator	Chrome	36-40	38	30 pcs
-	D238K-ZK-4SBU (Cr/N)	With Indicator		36-40		
-	D238K-ZK-5SBU (Cr/N)	With Cylinder Lock		40		
-	D251K-ZK-3SBU (Cr/N)	Without Indicator	Gold Nickel	36-40	51	
-	D251K-ZK-4SBU (Cr/N)	With Indicator		36-40		
-	D251K-ZK-5SBU (Cr/N)	With Cylinder Lock		40		

SLIDING DOOR LOCK

SC, SCU



* Pearl Chrome (Pcr), Satin Gold (SG) can be produced as special order.

Item Code	Item Name	Type	Colour	Door Thickness	Back Set	Box
-	D238K-ZK-3SC (Cr/N)	Without Indicator	Chrome	36-40	38	30 pcs
-	D238K-ZK-4SC (Cr/N)	With Indicator		36-40		
-	D238K-ZK-5SC (Cr/N)	With Cylinder Lock		40		
-	D251K-ZK-3SC (Cr/N)	Without Indicator	Gold Nickel	36-40	51	
-	D251K-ZK-4SC (Cr/N)	With Indicator		36-40		
-	D251K-ZK-5SC (Cr/N)	With Cylinder Lock		40		

Item Code	Item Name	Type	Colour	Door Thickness	Back Set	Box
-	D238K-ZK-3SCU (Cr/N)	Without Indicator	Chrome	36-40	38	30 pcs
-	D238K-ZK-4SCU (Cr/N)	With Indicator		36-40		
-	D238K-ZK-5SCU (Cr/N)	With Cylinder Lock		40		
-	D251K-ZK-3SCU (Cr/N)	Without Indicator	Gold Nickel	36-40	51	
-	D251K-ZK-4SCU (Cr/N)	With Indicator		36-40		
-	D251K-ZK-5SCU (Cr/N)	With Cylinder Lock		40		

SB type

• 3SB/3SBU (Outside)

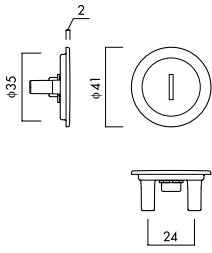

• 4SB/4SBU (Outside)

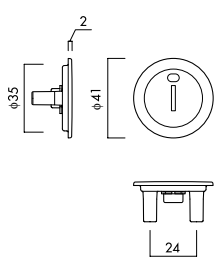

• 5SB/5SBU (Outside)

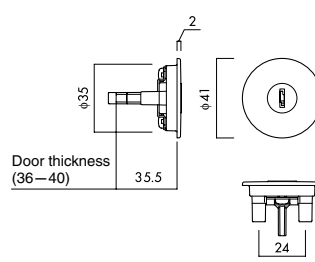

• 3SB/4SB/5SB (Inside)

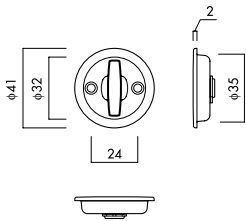

• 3SBU/4SBU/5SBU (Inside)

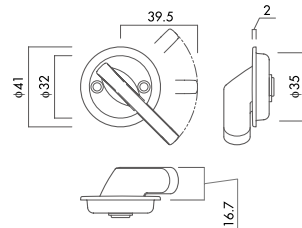

SC type

• 3SC/3SCU (Outside)

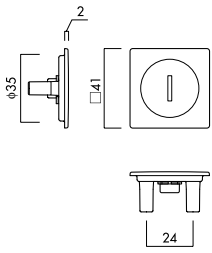

• 4SC/4SCU (Outside)

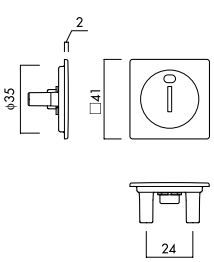

• 5SC/5SCU (Outside)

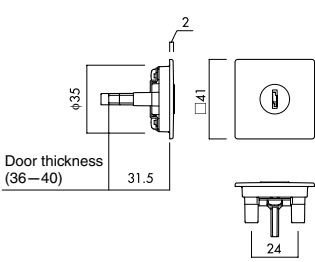

• 3SC/4SC/5SC (Inside)

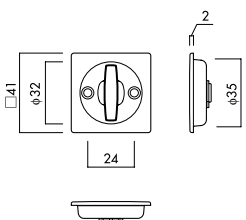

• 3SCU/4SCU/5SCU (Inside)

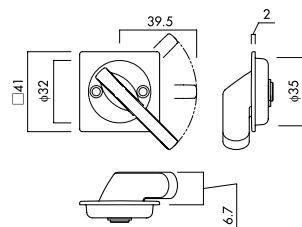

• Counter Plate

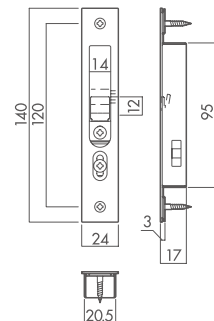

PROCESS

SB-SBU-SC-SCU type

• Frame

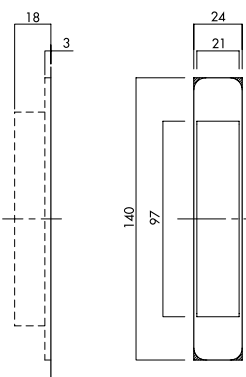

• Door

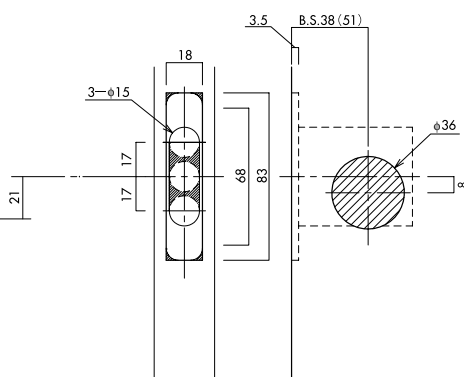

Lock (Back set 38 mm)



Lock (Back set 51 mm)

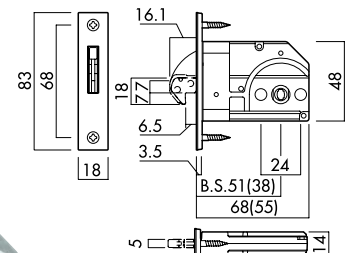

*Dimension in () is for 38 mm Back set