

BUTT HINGE FOR ALUMINIUM FRAME AS-HG-AL



- Special hinges fitting perfectly with the mounting groove of aluminium frame. No additional washers are required.
- Plastic bushes provide smooth movement and prevent metal-to-metal friction.
- Aluminium alloy material, light weight and excellent design.
- Stainless steel hinge AS-HG-SUS 1 of the same type also available.

[Remarks]

- Load capacity is the value when using two hinges. For calculation conditions, please refer to INDEX 2 .

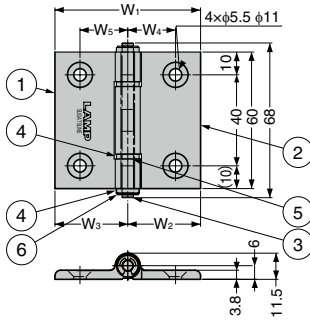

No.	Part Name	Material	Finish / Colour
①	Body A	Aluminium Alloy	Anodised Silver
②	Body B		
③	Shaft	Stainless Steel (SUS303)	Plain
④	Bush	POM	Natural
⑤	Washer	PEEK	
⑥	E-type Retaining Ring	Stainless Steel (SUS304)	-

RoHS	CAD	Item Code	Item Name	W ₁	W ₂	W ₃	W ₄	W ₅	Load Capacity N/2 pcs	Load Capacity kgf/2 pcs	Weight (g)	Box (pcs)	Carton (pcs)
☑	3D	170-011-679	AS-HG-AL-M3020	43	18		11		147	15	41	20	300
☑	3D	170-011-680	AS-HG-AL-M3030	50	25	25	16	16			45	20	300
☑	3D	170-011-681	AS-HG-AL-M3040	57			21				48	20	300
☑	3D	170-011-682	AS-HG-AL-M4040	64	32			21			53	20	300

Refer to 1 : P.175, 2 : P.15



Parts Set for Installing to Aluminium Frame

Please refer to the series introduction page 1 for details about AS series.

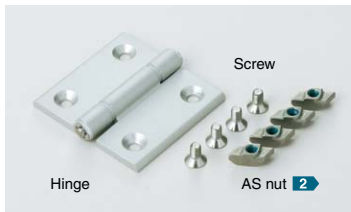

[AS Parts Set] Parts set of screws and AS nuts

RoHS	CAD	Item Code	Item Name	Aluminium Frame	Parts	Weight (g)
☑	-	170-041-810	AS-HG-AL-M3020-8	Groove Width 6 mm Groove Width 8 mm	Hinge AS-HG-AL-M3020 : 1pc AS Nut AS-8M5 : 2pcs Hexagon Socket Countersunk Head Screw M5 x 12 : 2pcs AS Nut AS-6M4 : 2pcs Hexagon Socket Countersunk Head Screw M4 x 10 : 2pcs	-
☑	-	170-041-811	AS-HG-AL-M3030-8	Groove Width 8 mm	Hinge AS-HG-AL-M3030 : 1pc AS Nut AS-8M5 : 4pcs Hexagon Socket Countersunk Head Screw M5 x 12 : 4pcs	-
☑	-	170-041-812	AS-HG-AL-M3040-10	Groove Width 8 mm Groove Width 10 mm	Hinge AS-HG-AL-M3040 : 1pc AS Nut AS-10M5 : 2pcs Hexagon Socket Countersunk Head Screw M5 x 12 : 2pcs AS Nut AS-8M5 : 2pcs Hexagon Socket Countersunk Head Screw M5 x 12 : 2pcs	-
☑	-	170-041-813	AS-HG-AL-M4040-8	Groove Width 8 mm	Hinge AS-HG-AL-M4040 : 1pc AS Nut AS-8M5 : 4pcs Hexagon Socket Countersunk Head Screw M5 x 12 : 4pcs	-
☑	-	170-041-814	AS-HG-AL-M4040-10	Groove Width 10 mm	Hinge AS-HG-AL-M4040 : 1pc AS Nut AS-10M5 : 4pcs Hexagon Socket Countersunk Head Screw M5 x 12 : 4pcs	-

[Installation]

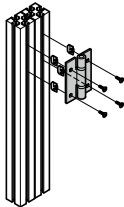

[Dimensions]

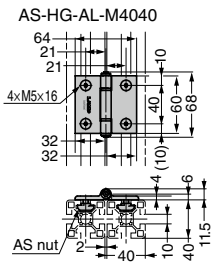
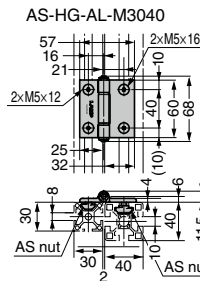
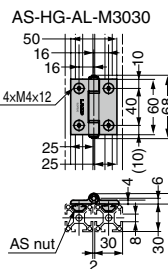
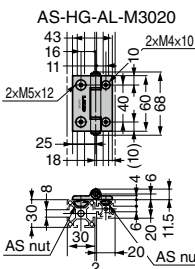

Refer to 1 : FRONT P.20, 2 : P.706