

LAMP® EXCELOCK® STRIKE PLATE FOR GLASS DOOR XL-ESG For Swing Door



• It perfectly matches style when used in combination with the glass hinge XL-GC04-CR 1.

[Features]

• The door needs to be properly closed for the lock to engage. We recommend the use of a door stopper or magnetic catch.

[Parts Included]

• Installation adjustment spacer

[Installation]

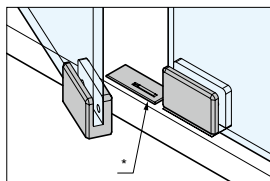
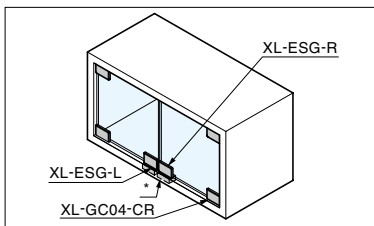

* XL-ELU lock unit 2 (Sold separately)

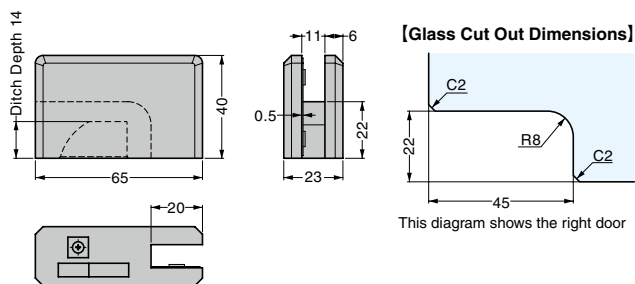

[Glass Cut Out Dimensions]

This diagram shows the right door

XL-ESG-R is shown. XL-ESG-L is symmetrically opposite.

RoHS	CAD	Item Code	Item Name	Specification	Material	Finish	Max. Door Width	Max. Door Height	Glass Thickness
-	2D3D	150-022-211	XL-ESG-R	Right	Zinc Alloy (ZDC)	Chrome	500	1200	5, 6, 8
-	2D3D	150-022-210	XL-ESG-L	Left					

Refer to 1 : No.240A P.449, 2 : P.E13

LAMP® EXCELOCK® STRIKE PLATE FOR WOOD DOOR XL-ESW



• It can be used with both a swing door and a slide door.

[Features]

• The door needs to be properly closed for the lock to engage. We recommend the use of a stopper or door guide for sliding doors, and a door stopper or magnetic catch for hinged doors.

[Parts Included]

• Cross-hole pan-head tapping screw 4x16

[Sold Separately]

• Lock unit XL-ELU 1

[Installation]

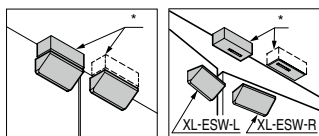
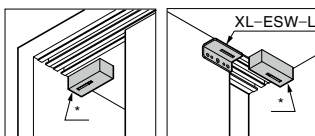
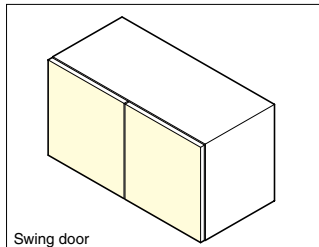
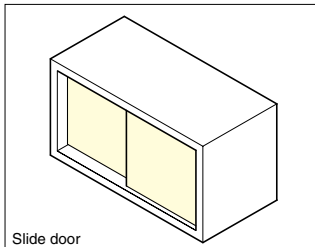

* Lock unit XL-ELU 1 (Sold separately)

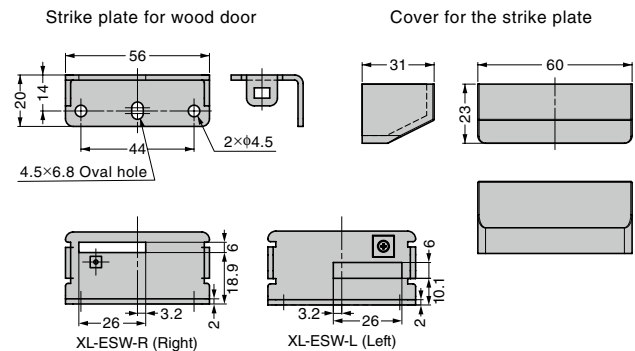

RoHS	CAD	Item Code	Item Name	Material	Finish	Colour	Max. Width/Slide door	Max. Width/Swing door	Max. Height
-	2D3D	150-023-021	XL-ESW-R	Stainless Steel (SUS304) / ABS resin	Barrel Polishing	Black	800	500	1200
-	2D3D	150-022-212	XL-ESW-L						

Refer to 1 : P.E13