

ALUMINIUM SPRING HINGE

L=R DAW



Features

- Hinge allows door to be opened forwards or backwards.
- Spring powered to automatically close.
- Spring strength is adjustable.
- Angle of opening movement in either direction is 180°.
- Please use in combination with door stoppers.

Remarks

Please use with door stopper.

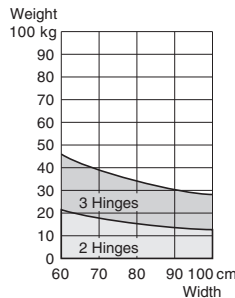

How to Adjust Spring Tension

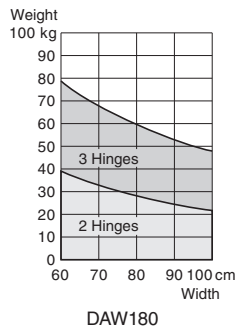
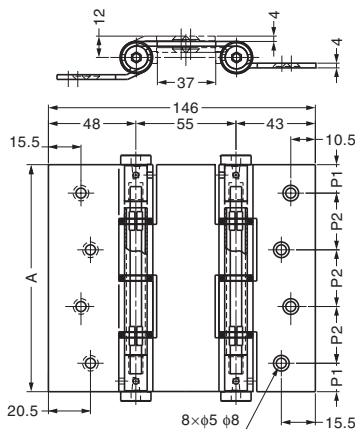
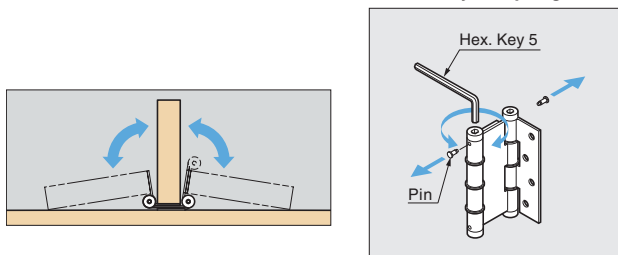

Item Code	Item Name	Material	Finish	A	P1	P2	Door Thickness	Weight	Box
170-017-703	DAW120	Aluminium Alloy	Anodized	120	15	30	Max. 35	342 g	2 pcs
170-017-702	DAW180	Aluminium Alloy	Anodized	180	22.5	45	Max. 35	506 g	2 pcs

※The dimension "8×φ5 φ8" will change to "8×φ5.3 φ10" when the current stock runs out.

ALUMINIUM SPRING LIFT-OFF HINGE

PM120



Features

- Successfully passed 250,000 open/close cycles in a private test.
- Spring powered to automatically close.
- Spring strength is adjustable.
- Easy to remove door from frame post-installation.

Installation

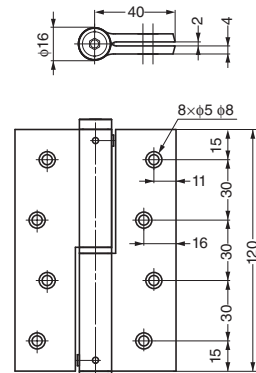
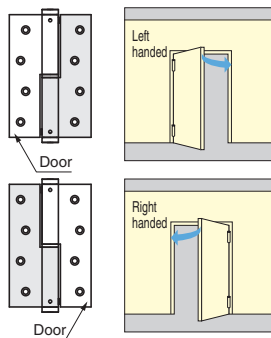

How to Adjust Spring Tension

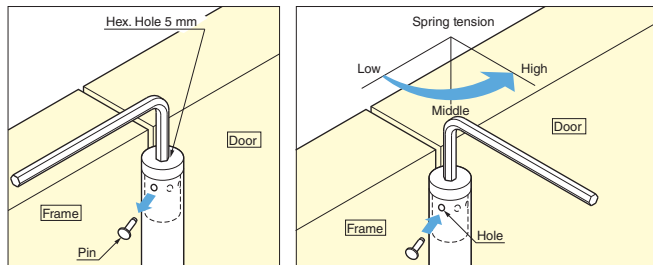

Loosen shaft with Hex key and remove the pin. Adjust spring tension with three steps. Put the pin to the hole and fix.

PM120-524401L

Item Code	Item Name	Material	Finish	Load Capacity (Door Width Max. 1000 mm)	Weight	Box
170-022-484	PM120-524401L	Aluminium Alloy	Anodized	200 N (20 kgf)/2 pcs	380 g	2 pcs
170-022-485	PM120-525401R	Aluminium Alloy	Anodized	300 N (30 kgf)/3 pcs	380 g	2 pcs

※The dimension "8×φ5 φ8" will change to "8×φ5.3 φ10" when the current stock runs out.