

MAGNETIC CATCH (SNAP-IN TYPE)

MC-YSW

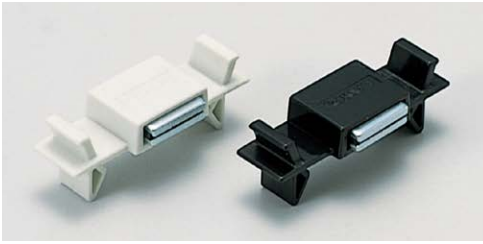

Features

- For use on sheet metal.
- Thin body works well in tight spaces.
- Easy to attach and detach.
- MC-YSW02 model: Powerful neodymium magnet.
- MC-YSW01 model : Less powerful ferrite magnet.

Remarks

Max. temperature for neodymium magnet: 80°C

Sold Separately

Spacer: YS-P05

Cut Out Dimensions

For 1 mm door (Need YS-P05) and 1.6 mm door (No need YS-P05)

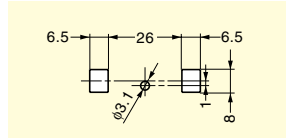

For 2 mm door (Need YS-P05) and 2.6 mm door (No need YS-P05)

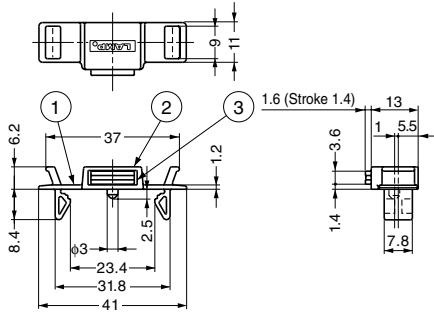
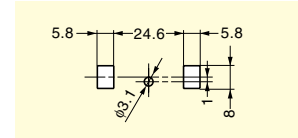

No.	Material		Finish/Colour	
	①	MC-YSW01	MC-YSW02	MC-YSW01
①	Polyacetal (POM)		White, Black	
②	Steel		Clear Zinc Chromate	Yellow Zinc Chromate
③	Ferrite	Neodymium	-	Nickel



Spacer: YS-P05

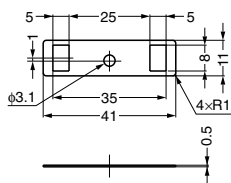

Body

Item Code	Item Name	Colour	Magnet	Magnetic Force	Weight	Box	Carton
140-050-001	MC-YSW01W	White	Ferrite	12 N	1.2 kgf	5 g	100 pcs, 1,000 pcs
140-050-028	MC-YSW01B	Black	Ferrite	12 N	1.2 kgf	5 g	100 pcs, 1,000 pcs
140-050-002	MC-YSW02W	White	Neodymium	29 N	3 kgf	5.5 g	100 pcs, 1,000 pcs
140-050-029	MC-YSW02B	Black	Neodymium	29 N	3 kgf	5.5 g	100 pcs, 1,000 pcs

Spacer (Sold Separately)

Item Code	Item Name	Material	Colour	Weight	Box
140-050-003	YS-P05	Polypropylene (PP)	Natural	0.16 g	1,000 pcs

MAGNETIC CATCH (SNAP-IN TYPE)

MC-FP5S

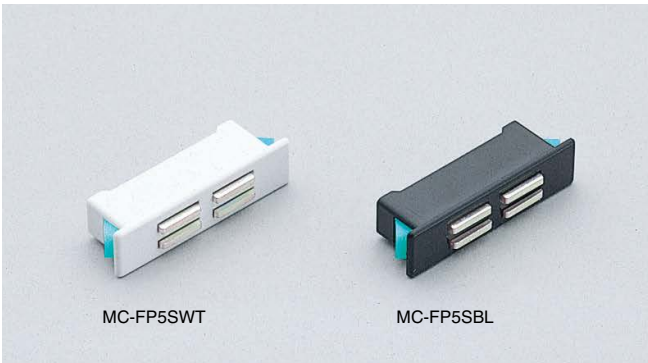

Features

Compact size with strong magnetic force.

Remarks

Max. temperature: 80°C

Sold Separately

- Counter plate (SUS): MC-JM49 (P.273)
- Counter plate SP0207 (P.273)

Installation

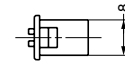
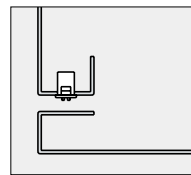

Cut Out Dimensions

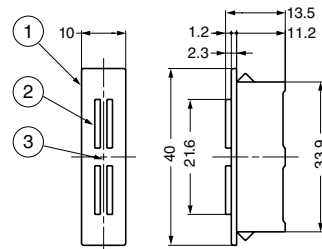
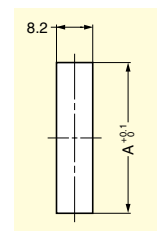

Door Thickness	A
0.8	34.1
1	34.1
1.2	34.5
1.4	34.5
1.6	35
1.8	35.5
2	36.5

No.	Part Name	Material	Finish/Colour
①	Body	ABS	White/Black
②	Yoke	Steel	Yellow Zinc Chromate
③	Magnet	Neodymium	-

Item Code	Item Name	Colour	Magnetic Force N	Magnetic Force kgf	Weight	Box	Carton
140-050-268	MC-FP5SWT	White	44.1 N	4.5 kgf	9 g	200 pcs	2,000 pcs
140-050-269	MC-FP5SBL	Black	44.1 N	4.5 kgf	9 g	200 pcs	2,000 pcs