

Robots-Set ECBPM ROB-SET PLUS ECBPMi UR

Part no.:10.03.01.00617

<https://www.schmalz.com/10.03.01.00617>

Homepage > Vacuum Technology for Automation > Vacuum Components > Vacuum Generators > Electrical Vacuum Generators > Handling Sets ECBPM > ROB-SET PLUS ECBPMi UR

Complete set for connecting and integrating the CobotPump ECBPMi to lightweight robots



with: PLUS
with: CobotPump mini
for: Universal Robots
Type: UR3/5
contains: Suction Pad
and: Screws
Degree of evacuation: 60 %

Design Data

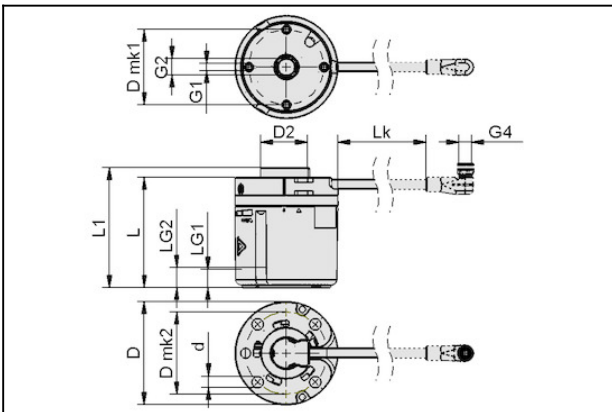

Attribute	Value
Lk	120.5 mm
D	63 mm
D2	31.5 mm
D mk1	46 mm
D mk2	50 mm
G1	M4-F
G2	G1/4"-F
G4	M8-F
L	67.4 mm
L1	73.4 mm
LG1	6 mm
LG2	11.5 mm

Contact to Schmalz

J. Schmalz GmbH | Johannes-Schmalz-Straße, 72293 Glatten, Deutschland | +49 7443 2403-102 | customercenter@schmalz.de

Robots-Set ECBPM

ROB-SET PLUS ECBPMi UR

Part no.:10.03.01.00617

<https://www.schmalz.com/10.03.01.00617>



Technical Data

Attribute	Value
Suction rate (max.)	1.6 l/min
Degree of evacuation	60 %
Voltage DC	24V-DC
Rated power	7.2 W
Rated current	0.3 A
Electrical connection	Elb fem conn M8, 8 pol
Operating temperature	0 ... 40 °C
Protection type IP	IP 40
for	Universal Robots

Spare Parts



ECBPMi-RS-485 24V-DC FK

Part no.10.03.01.00584

CobotPump (Mini) for electrical vacuum generation for collaborative robots

Suction rate (max): 1.6 l/min

Rated power: 7.2 W

Voltage: 24V - DC

Rated current: 0.3 A

Electrical connection: Spring contact

Noise level (max): 57 dB

Ambient temperature: 0 ... 40 °C

Contact to Schmalz

J. Schmalz GmbH | Johannes-Schmalz-Straße, 72293 Glatten, Deutschland | +49 7443 2403-102 | customercenter@schmalz.de

Robots-Set ECBPM

ROB-SET PLUS ECBPMi UR

Part no.:10.03.01.00617

<https://www.schmalz.com/10.03.01.00617>



SPB1 30 ED-65 G1/4-AG

Part no.10.01.06.04530

Bellows suction cup (round) for very uneven workpieces

Size: 30

Suction cup material: Elastodur

Material hardness: 65 °Sh

Thread G1: G1/4"-M

Number of folds: 1.5



SFF 20 SI-55 G1/4-AG

Part no.10.01.01.14621

Flat suction cup (round) for dynamic handling of thin and flexible workpieces

Size: 20

Suction cup material: Silicone SI

Material hardness: 55 °Sh

Thread G1: G1/4"-M

Material characteristics:

FDA-compatible