

Flat suction cup (round)

SUF 25 NBR-ESD-55 G1/8-IG

Part no.:10.01.01.14128

<https://www.schmalz.com/10.01.01.14128>

Homepage > Vacuum Technology for Automation > Vacuum Components > Vacuum Suction Cups > Flat suction cup (round) > Flat Suction

Cups SUF > SUF 25 NBR-ESD-55 G1/8-IG

Flat suction cup (round) for process safe handling of smooth or slightly rough surfaces



Size: 25

Suction cup material:

Nitrile rubber NBR-dissipative

Material hardness: 55 °Sh

Design Data

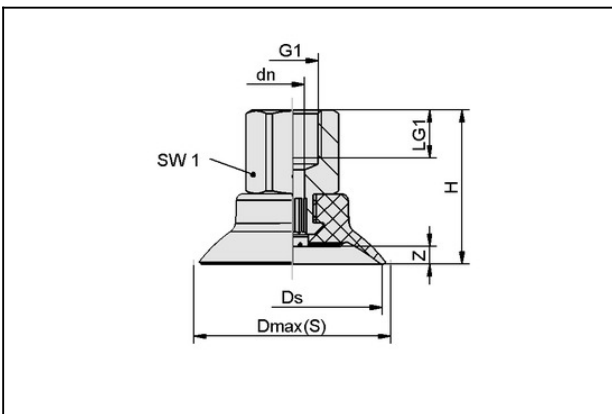

Attribute	Value
Dmax(S)	28.2 mm
Ds	25 mm
dn	4.1 mm
G1	G1/8"-F
H	25.2 mm
LG1	8 mm
SW1	14 mm
Z (Stroke)	2.5 mm

Technical Data

Contact to Schmalz

J. Schmalz GmbH | Johannes-Schmalz-Straße, 72293 Glatten, Deutschland | +49 7443 2403-102 | customercenter@schmalz.de

Flat suction cup (round)

SUF 25 NBR-ESD-55 G1/8-IG

Part no.:10.01.01.14128

<https://www.schmalz.com/10.01.01.14128>



Attribute	Value
Size	25
Suction cup material	Nitrile rubber NBR-dissipative
Material hardness [Shore A]	55.0 Shore A
Abreißkraft (real)	23.4 N
Product family	SUF

Spare Parts

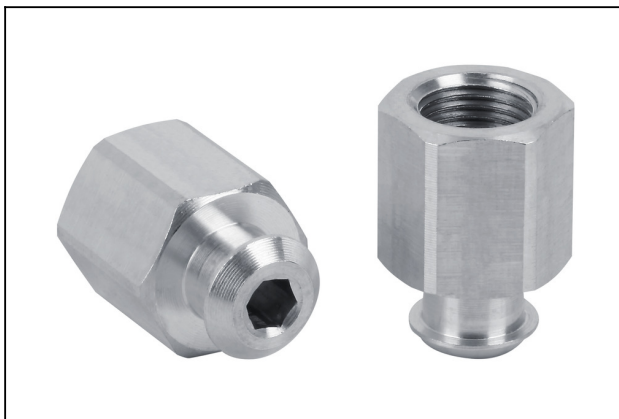

SC 040 G1/8-IG

Part no.10.01.06.02482

Connection element for suction cup "SchmalzConnector"

Connection geometry: 040

Vacuum connection: G1/8"-F

Overall length: 20.7 mm

Fitting length: 14 mm

Nominal diameter dn: 4.1 mm

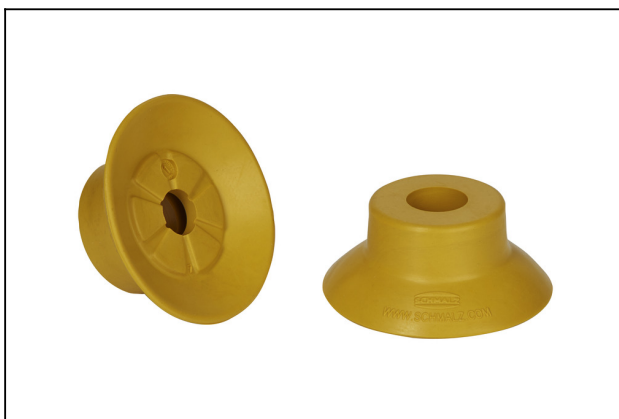

SUF 25 NBR-ESD-55 SC040

Part no.10.01.01.14038

Flat suction cup (round) f. process- safe handling of smooth or slightly rough surfaces

Size: 25

Suction cup material:

Nitrile rubber NBR-dissipative

Material hardness: 55 °Sh