

## ALUMINIUM STRIP AIRMOVER SE75

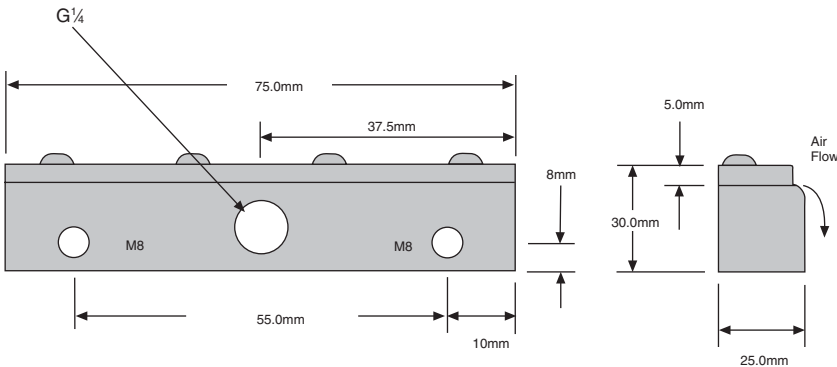

**Material:** Aluminium/Zinc plated steel

**Weight:** 0.16Kg

**Standard Gap:** 0.05-0.10mm

**dB(A) at:** 5.5 bar is 80

**Shims:** Not Applicable

**Standard Inlet Threads:** G $\frac{1}{4}$

**Options:**  $\frac{1}{4}$ " NPT  
Please specify on order  $\frac{1}{4}$ " NPTF

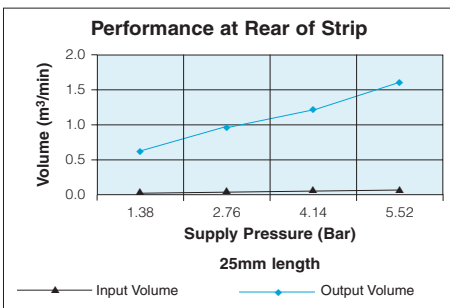

Bar	Vol in m <sup>3</sup> /min	Vol out m <sup>3</sup> /min
1.38	0.034	0.651
2.76	0.054	0.963
4.14	0.074	1.218
5.52	0.093	1.642

per 25mm length

## ALUMINIUM STRIP AIRMOVER SE150

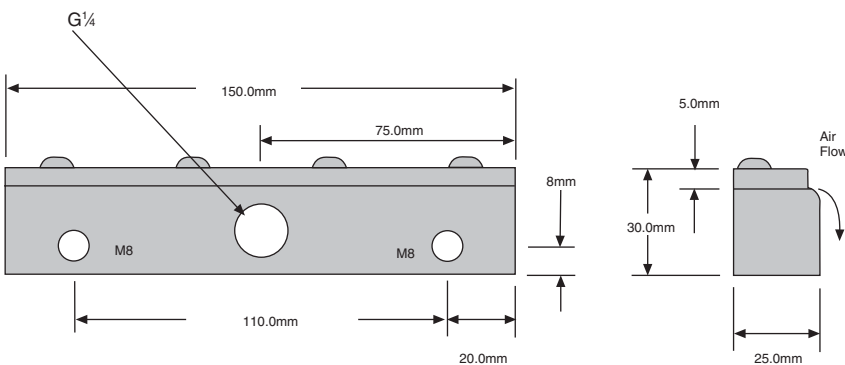

**Material:** Aluminium/Zinc plated steel

**Weight:** 0.324Kg

**Standard Gap:** 0.05-0.10mm

**dB(A) at:** 5.5 bar is 80

**Shims:** Not Applicable

**Standard Inlet Threads:** G $\frac{1}{4}$

**Options:**  $\frac{1}{4}$ " NPT  
Please specify on order  $\frac{1}{4}$ " NPTF

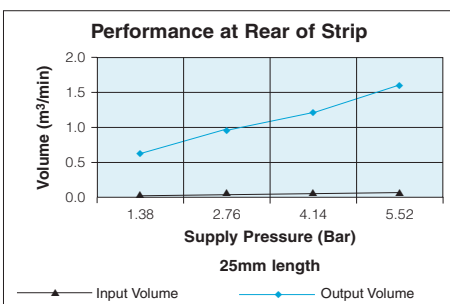

Bar	Vol in m <sup>3</sup> /min	Vol out m <sup>3</sup> /min
1.38	0.034	0.651
2.76	0.054	0.963
4.14	0.074	1.218
5.52	0.093	1.642

per 25mm length

## SE300 ALUMINIUM STRIP AIRMOVER

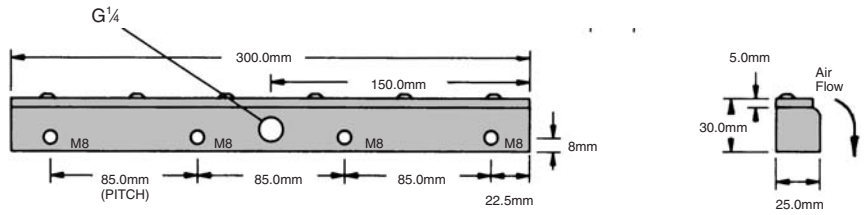

**Material:** Aluminium/Zinc plated steel

**Weight:** 0.7Kg

**Standard Gap:** 0.05-0.10mm

**dB(A) at:** 5.5 bar is 80

**Shims:** Not Applicable

**Standard Inlet Threads:** G $\frac{1}{4}$

**Options:**  $\frac{1}{4}$ " NPT  
Please specify on order  $\frac{1}{4}$ " NPTF

Bar	Vol in m <sup>3</sup> /min	Vol out m <sup>3</sup> /min
1.38	0.034	0.651
2.76	0.054	0.963
4.14	0.074	1.218
5.52	0.093	1.642

per 25mm length

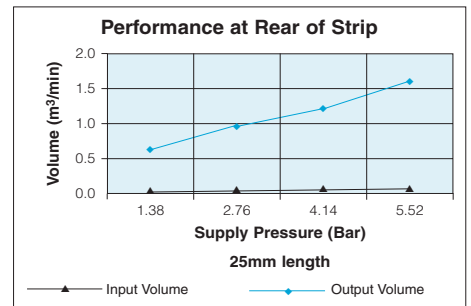

## SE450 ALUMINIUM STRIP AIRMOVER

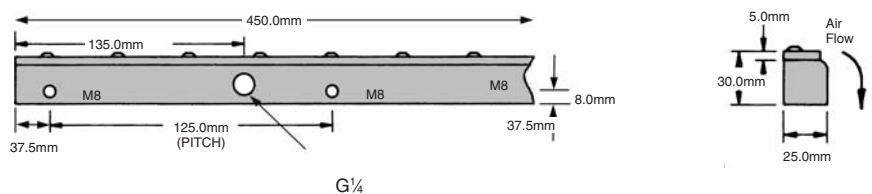

**Material:** Aluminium/Zinc plated steel.

**Weight:** 1.0Kg

**Standard Gap:** 0.05-0.10mm

**dB(A) at:** 5.5 bar is 80

**Shims:** Not Applicable

**Standard Inlet Threads:** G $\frac{1}{4}$

**Options:**  $\frac{1}{4}$ " NPT  
Please specify on order  $\frac{1}{4}$ " NPTF

Bar	Vol in m <sup>3</sup> /min	Vol out m <sup>3</sup> /min
1.38	0.034	0.651
2.76	0.054	0.963
4.14	0.074	1.218
5.52	0.093	1.642

per 25mm length

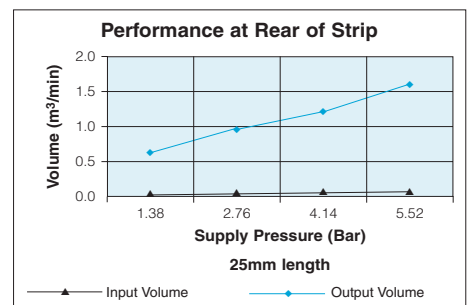

## ALUMINIUM STRIP AIRCOVER SE600

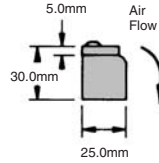
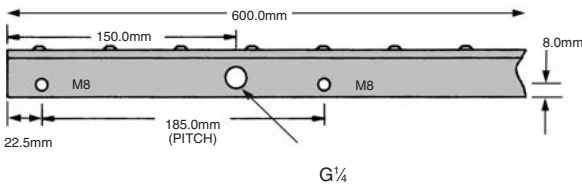

**Material:** Aluminium/Zinc plated steel.

**Weight:** 1.35Kg

**Standard Gap:** 0.05-0.10mm

**dB(A) at:** 5.5 bar is 80

**Shims:** Not Applicable

**Standard Inlet Threads:** G $\frac{1}{4}$

**Options:**  $\frac{1}{4}$ " NPT  
Please specify on order  $\frac{1}{4}$ " NPTF

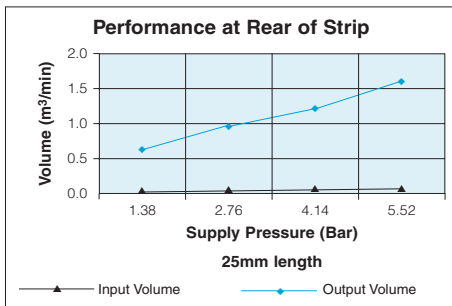

Bar	Vol in m³/min	Vol out m³/min
1.38	0.034	0.651
2.76	0.054	0.963
4.14	0.074	1.218
5.52	0.093	1.642

per 25mm length

## ALUMINIUM STRIP AIRCOVER SE750

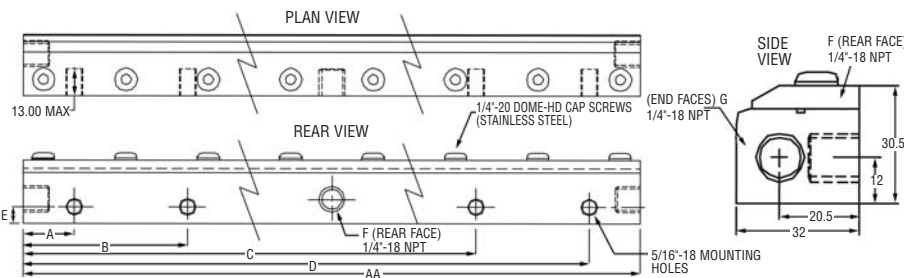

PART NO. (Stainless Steel)	AA	A	B	C	D	E	F # of Rear Inlets	G # of Side Inlets
Model SE750	30" 761mm	1.4" 35mm	8.9" 227mm	19.1" 485mm	28.6" 727mm	0.3" 8mm	2	2



**Material:** Aluminium/Zinc plated steel.

**Weight:** 3.6Kg

**Standard Gap:** 0.05-0.10mm

**dB(A) at:** 5.5 bar is 80

**Shims:** Not Applicable

**Standard Inlet Threads:** G $\frac{1}{4}$

**Options:**  $\frac{1}{4}$ " NPT  
Please specify on order  $\frac{1}{4}$ " NPTF

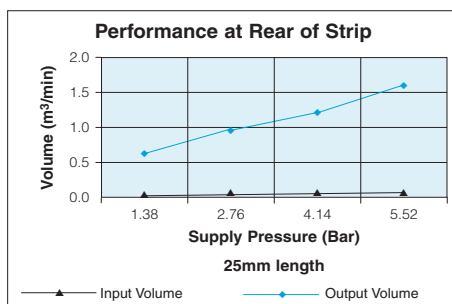

Bar	Vol in m³/min	Vol out m³/min
1.38	0.034	0.651
2.76	0.054	0.963
4.14	0.074	1.218
5.52	0.093	1.642

per 25mm length

## SE900 ALUMINIUM STRIP AIRMOVER

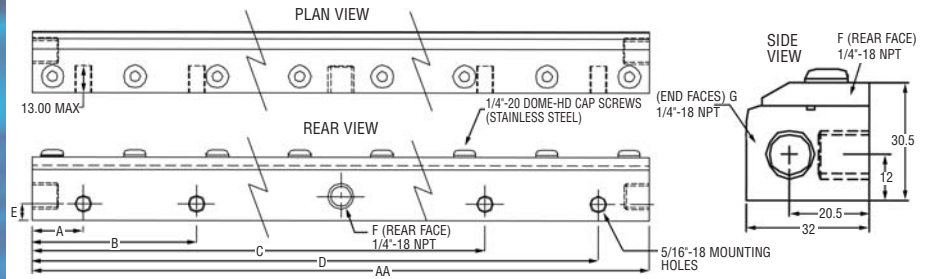
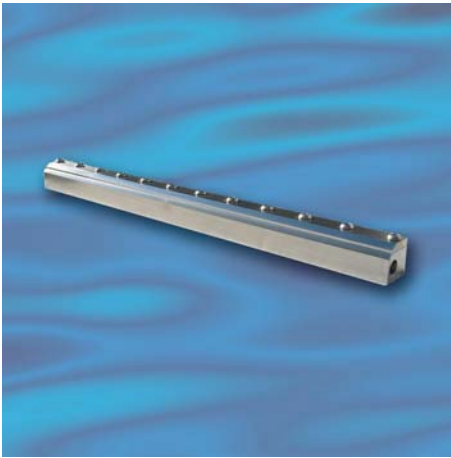

PART NO. (Stainless Steel)	AA	A	B	C	D	E	F # of Rear Inlets	G # of Side Inlets
Model SE900	36" 914mm	1.4" 35mm	10.9" 277mm	26.9" 683.5mm	34.6" 879mm	0.3" 8mm	2	2

**Material:** Aluminium/Zinc.

**Weight:** 4.3Kg

**Standard Gap:** 0.05-0.10mm

**dB(A) at:** 5.5 bar is 80

**Shims:** Not Applicable

**Standard Inlet Threads:** G $\frac{1}{4}$

**Options:**  $\frac{1}{4}$ " NPT  
Please specify on order  $\frac{1}{4}$ " NPTF

Bar	Vol in m <sup>3</sup> /min	Vol out m <sup>3</sup> /min
1.38	0.034	0.651
2.76	0.054	0.963
4.14	0.074	1.218
5.52	0.093	1.642

per 25mm length

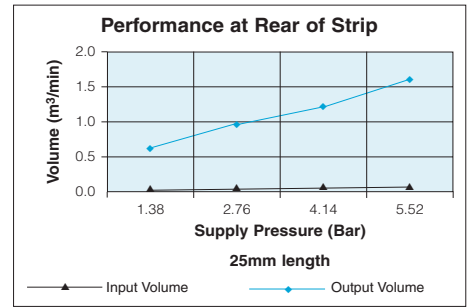

## SE75SS STAINLESS STEEL STRIP AIRMOVER

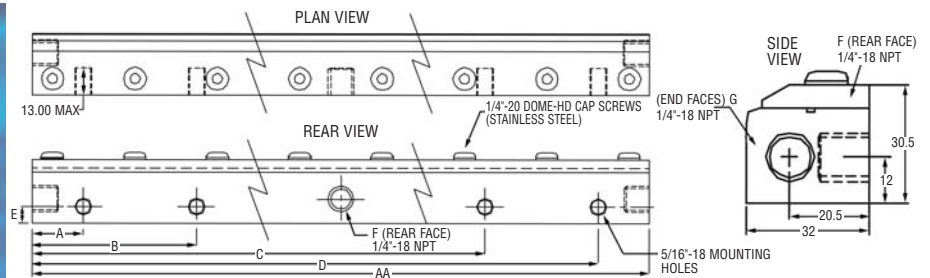

PART NO. (Stainless Steel)	AA	A	B	C	D	E	F # of Rear Inlets	G # of Side Inlets
Model SE75SS	3" 76mm	0.6" 16mm	-	-	2.4" 60mm	0.3" 8mm	1	2

**Material:** Stainless Steel (Grade 304)

**Weight:** 0.37

**Standard Gap:** 0.05-0.10mm

**dB(A) at:** 5.5 bar is 80

**Shims:** Not Applicable

**Standard Inlet Threads:** G $\frac{1}{4}$

**Options:**  $\frac{1}{4}$ " NPT  
Please specify on order  $\frac{1}{4}$ " NPTF

Bar	Vol in m <sup>3</sup> /min	Vol out m <sup>3</sup> /min
1.38	0.034	0.651
2.76	0.054	0.963
4.14	0.074	1.218
5.52	0.093	1.642

per 25mm length

