

**ANGLE-ADJUSTABLE DETENT HINGE HG-CHJ70**

INSTRUCTION



HG-CHJ70WT

HG-CHJ70BL

- Holds at 4 angles: -3°, -90°, 90°, and 177°. (Factory setting)
- The holding angle of 90° can be switched to 45° or 135°.
- Can be used both vertically and horizontally.

**[Applications]**

- Environmental test equipment, laboratory equipment.

**[Remarks]**

- Adjustment of detent angles must be done when the hinge is open.
- The retaining torque may vary.

**[Recommended Screw]**

- Hexagon socket head bolt M5

**[Available Detent Angles]**

- 45°

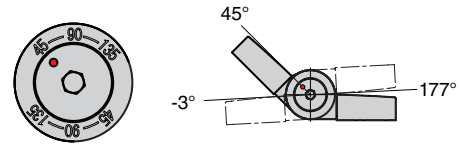

- 90° (factory setting)

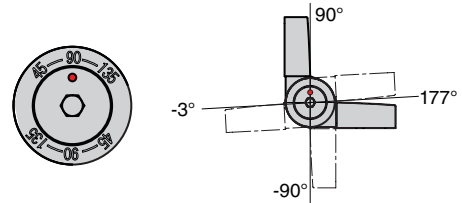

- 135°

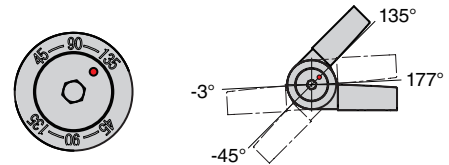

**[Without Covers]**



**[Application Example]**



Detent angle: 45°

**[Switching 45° ↔ 90° ↔ 135° ]**

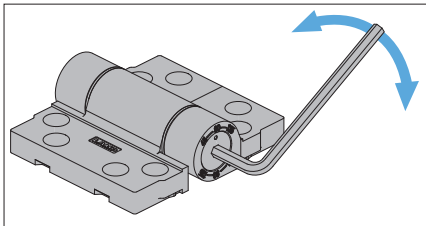

Can be adjusted by a hex key.

**[Available Door Specs] When using two hinges**

- Lateral opening

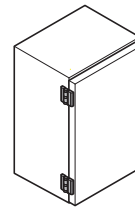

- Weight: Max. 8kg
- Width: Max. 500mm
- Height: Max. 1,000mm

- Upward opening

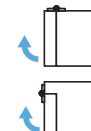

- Moment: Max. 1.7N·m
- Height: Max. 250mm

- Top opening

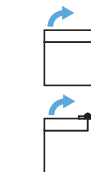

- Moment: Max. 2.4N·m
- Height: Max. 300mm

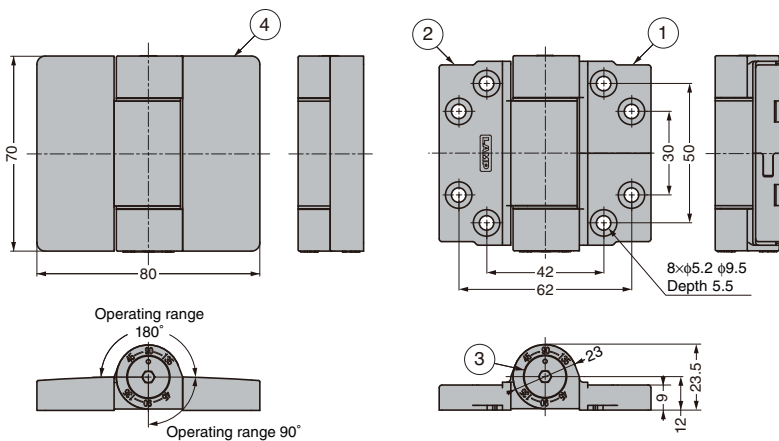

**Video Link**



No.	Part Name	Material
①	Fixed Bracket	POM
②	Movable Bracket	
③	Shaft	Stainless Steel
④	Cover	ABS

RoHS	CAD	Item Code	Item Name	Colour	Retaining Torque N·m / pc	Retaining Torque kgf·cm / pc	Weight (g)	Box (pcs)	Carton (pcs)
		170-043-659	HG-CHJ70BL	Black	2	20.4	115	10	80
		170-043-660	HG-CHJ70WT	White				10	80