

技術資料 Technische Documentatie **Documentation**
Documentação técnica Documentación técnica Documentazione tecnica
Technische Dokumentation Technical Documentation Техническая документация
Documentazione tecnica Technische documentatie
Техническая документация **Teknik Doküman** 技术资料
Documentazione tecnica Dokumentacja techniczna
Technische documentatie Documentación técnica 技術資料
기술 자료 Technische documentatie 技術資料
Documentation technique Teknik Doküman Dokumentacja techniczna
Technical Documentation **Documentazione tecnica** Technical Documentation
Dokumentacja techniczna 技术资料 Documentation technique
Техническая документация Technische Dokumentation **Teknik Doküman**
Dokumentacja techniczna Technische documentatie
Documentation technique 기술 자료 Dokumentacja techniczna



Mini Compact Ejector SCPMi

Operating Instructions

Note

The Operating instructions were originally written in German. Store in a safe place for future reference. Subject to technical changes without notice. No responsibility is taken for printing or other types of errors.

Published by

© J. Schmalz GmbH, 06/19

This document is protected by copyright. J. Schmalz GmbH retains the rights established thereby. Reproduction of the contents, in full or in part, is only permitted within the limits of the legal provisions of copyright law. Any modifications to or abridgments of the document are prohibited without explicit written agreement from J. Schmalz GmbH.

Contact

J. Schmalz GmbH
Johannes-Schmalz-Str. 1
72293 Glatten, Germany
T: +49 7443 2403-0
schmalz@schmalz.de
www.schmalz.com

Contact information for Schmalz companies and trade partners worldwide can be found at:
www.schmalz.com/salesnetwork

Contents

1	Important Information	6
1.1	Note on Using this Document	6
1.2	The technical documentation is part of the product	6
1.3	Warnings in This Document	6
1.4	Symbol	6
1.5	Type Plate	7
2	Fundamental Safety Instructions	8
2.1	Emissions	8
2.2	Intended Use	8
2.3	Non-Intended Use	8
2.4	Personnel Qualifications	9
2.5	Modifications to the Ejector	9
3	Product Description	10
3.1	Operating Modes	10
3.2	Ejector Designation	10
3.3	Ejector Structure	10
3.4	Controls and Displays in Detail	11
4	Description of the Ejector	13
4.1	Suction of the Workpiece (Vacuum Generation)	13
4.2	Depositing the Workpiece/Part (Blowing Off)	14
5	Technical Data	15
5.1	Display Parameters	15
5.2	General Parameters	15
5.3	Electrical Parameters	15
5.4	Mechanical Data	16
5.4.1	Performance Data	16
5.4.2	Dimensions	16
5.4.3	Maximum Torque	17
5.4.4	Pneumatic circuit plans	17
5.4.5	Factory Settings	18
6	Operating and Menu Concept	19
6.1	Button Assignments in Display Mode	19
6.1.1	Opening the Menu	19
6.1.2	Displaying the Basic Settings (Slide Show)	20
6.2	Main Menu	20
6.2.1	Functions in the Main Menu	20
6.2.2	Changing the Parameters of the Main menu	20
6.3	Extended Functions menu (EF)	21
6.3.1	Functions in the Extended Functions menu (EF)	21
6.3.2	Changing parameters in the Extended Functions menu	22
6.4	Info menu [INF]	23
6.4.1	Functions in the Info menu	23
6.4.2	How Data is Displayed in the Info Menu	23
7	Interfaces	25
7.1	Basic Principles of IO-Link Communication	25

7.2	Process Data	25
7.3	ISDU Parameter Data	25
7.4	Near Field Communication (NFC)	26
8	Description of Functions.....	27
8.1	Operating Modes	27
8.1.1	Automatic Operation	27
8.1.2	Manual Mode	27
8.1.3	Setting Mode	28
8.2	Monitoring the System Vacuum and Defining Limit Values	29
8.3	Calibrating the Vacuum Sensor [0x0002]	29
8.4	Control Functions [P-0: 0x0044]	29
8.4.1	No Control (Continuous Suction).....	30
8.4.2	Control	30
8.4.3	Control with Leak Monitoring.....	30
8.4.4	Control Shutoff [P-0: 0x004E]	30
8.5	Blow-Off Modes [0x0045]	30
8.5.1	Externally controlled blow-off.....	31
8.5.2	Internally time-controlled blow-off	31
8.5.3	Externally Time-Controlled Blow-Off	31
8.5.4	Setting the Blow-Off Time [P-0: 0x006A]	31
8.6	Output function [0x0047]	31
8.7	Output type [0x0049]	31
8.8	Selecting a Display Unit [0x004A].....	31
8.9	Switch-Off Delay [0x004B]	32
8.10	Rotating the Display [0x004F].....	32
8.11	ECO Mode [0x004C].....	32
8.12	Locking and Unlocking the Menus.....	32
8.12.1	PIN Code [0x004D]	33
8.12.2	Unlocking the Menus	33
8.13	Restricting Access Using Device Access Locks [0x000C]	34
8.14	Restricting Access with Extended Device Access Locks [0x005A].....	34
8.15	Resetting to Factory Settings (Clear All) [0x0002]	34
8.16	Counters.....	35
8.17	Displaying the Software Version	36
8.18	Displaying the Part Number [0x00FA].....	36
8.19	Displaying the Serial Number [0x0015].....	37
8.20	Device Data.....	37
8.21	User-Specific Localization	38
8.22	Process Data Monitoring.....	38
8.23	Production Setup Profiles	38
8.24	Energy and Process Control (EPC).....	38
8.24.1	Condition Monitoring (CM) [0x0092]	39
8.24.2	Energy Monitoring (EM) [0x009B, 0x009C, 0x009D].....	42
8.24.3	Predictive Maintenance (PM)	43
8.24.4	Reading the EPC Values	43
9	Transport and Storage.....	45
9.1	Checking the Delivery	45
10	Installation.....	46
10.1	Installation Instructions.....	46

10.2 Mounting	46
10.3 Pneumatic Connection	47
10.3.1 Connecting the Compressed Air and Vacuum	48
10.3.2 Instructions for the Pneumatic Connection	48
10.3.3 Optional: External blow-off connection (EB).....	49
10.4 Electrical connection	49
10.4.1 Pin Assignments.....	50
11 Operation	51
11.1 Operation via IO-Link.....	51
11.2 General Preparations	51
11.3 Changing the Blow-Off Flow Rate on the Ejector.....	52
12 Troubleshooting.....	53
12.1 Help with Faults.....	53
12.2 Error Codes, Causes and Solutions	54
12.3 System condition monitoring (CM)	55
12.4 Warnings and Error Messages in IO-Link Mode	55
13 Maintenance.....	56
13.1 Safety	56
13.2 Cleaning the Ejector.....	56
13.3 Replacing the Silencer.....	57
14 Warranty.....	59
15 Spare and Wearing Parts, Accessories.....	60
15.1 Spare and Wearing Parts	60
15.2 Accessories	60
16 Decommissioning and Recycling.....	61
16.1 Disposing of the Ejector.....	61
16.2 Materials Used	61
17 Appendix	62
17.1 Overview of Display Codes	62
17.2 EC Declaration of Conformity.....	63
17.3 SCPMi Data Dictionary 21.10.01.00125_00.pdf.....	64

1 Important Information

1.1 Note on Using this Document

J. Schmalz GmbH is generally referred to as Schmalz in these Operating instructions.

These Operating instructions contain important notes and information about the different operating phases of the product:

- Transport, storage, start of operations and decommissioning
- Safe operation, required maintenance, rectification of any faults

The Operating instructions describe the product at the time of delivery by Schmalz.

1.2 The technical documentation is part of the product

1. For problem-free and safe operation, follow the instructions in the documents.
2. Keep the technical documentation in close proximity to the product. The documentation must be accessible to personnel at all times.
3. Pass on the technical documentation to subsequent users.
 - ⇒ Failure to follow the instructions in these Operating instructions may result in life-threatening injuries!
 - ⇒ Schmalz is not liable for damage or malfunctions that result from failure to heed these instructions.

If you still have questions after reading the technical documentation, contact Schmalz service at:

www.schmalz.com/services

1.3 Warnings in This Document

Warnings warn against hazards that may occur when handling the product. This document contains three levels of danger that you can recognize by the signal word.

Signal word	Meaning
WARNING	Indicates a medium-risk hazard which, if not avoided, could result in death or serious injury.
CAUTION	Indicates a low-risk hazard which, if not avoided, could result in minor or moderate injury.
NOTE	Indicates a danger that leads to property damage.

1.4 Symbol



This sign indicates useful and important information.

- ✓ This symbol represents a prerequisite that must be met prior to an operational step.
- ▶ This sign represents an action to be performed.
- ⇒ This sign represents the result of an action.

Actions that consist of more than one step are numbered:

1. First action to be performed.
2. Second action to be performed.

1.5 Type Plate



The type plate (1) is permanently attached to the ejector and must always be clearly legible.

The type plate contains the following data:

- Name, including individual configuration code "AAA"
- Part number
- Serial number
- Pneumatic symbol
- Permitted pressure range

Please specify all the information above when ordering replacement parts, making warranty claims or for any other inquiries.

2 Fundamental Safety Instructions

2.1 Emissions

The ejector emits noise due to its use of compressed air.



⚠ WARNING

Noise pollution due to the escape of compressed air

Hearing damage!

- ▶ Wear ear protectors.
 - ▶ The ejector must only be operated with a silencer.
-

2.2 Intended Use

The ejector is built in accordance with the latest standards of technology and is safe to operate upon delivery; however, hazards can still arise during use.

The ejector is designed to generate a vacuum for gripping and transporting objects when used in conjunction with suction cups. It is operated via a controller using IO-Link.

Neutral gases are approved as evacuation media. Neutral gases include air, nitrogen and inert gases (e.g. argon, xenon and neon).

The product is intended for industrial use.

Intended use includes observing the technical data and the installation and operating instructions in this manual.

2.3 Non-Intended Use



⚠ WARNING

Extraction of hazardous media, liquids or bulk material

Personal injury or damage to property!

- ▶ Do not extract harmful media such as dust, oil mists, vapors, aerosols etc.
 - ▶ Do not extract aggressive gases or media such as acids, acid fumes, bases, biocides, disinfectants or detergents.
 - ▶ Do not extract liquids or bulk materials, e.g. granulates.
-

Schmalz accepts no liability for damages resulting from use other than as intended by Ejector. In particular, the following are considered non-intended use:

- Use in potentially explosive atmospheres
- Use in medical applications
- Lifting people or animals
- Evacuation of objects that are in danger of imploding

2.4 Personnel Qualifications

Unqualified personnel cannot recognize dangers and are therefore exposed to higher risks!

1. Task only qualified personnel to perform the tasks described in this Operating instructions.
2. The product must be operated only by persons who have undergone appropriate training.

This Operating instructions is intended for fitters who are trained in handling the product and who can operate and install it.

2.5 Modifications to the Ejector

Schmalz assumes no liability for consequences of modifications over which it has no control:

1. The ejector must be operated only in its original condition as delivered.
2. Use only original spare parts from Schmalz.
3. The ejector must be operated only in perfect condition.

3 Product Description

3.1 Operating Modes

If the ejector is connected to the supply voltage, it is ready for operation. This is the normal operating mode, in which the ejector is operated by the system controller.

The ejector is parameterized via the available menus or via IO-Link.

The following operating modes are available during the setup process:

- Setting mode (only via IO-Link) and
- Manual mode

3.2 Ejector Designation

The breakdown of the item designation (e.g. SCPMi 10 S04 NC M8-6 BLT) is as follows:

Feature	Variants	
Type	SCPM	
Version	Intelligent: i	
Nozzle size	0.3, 0.5, 0.7 and 1.0 mm	
Fluid connector	S01 (push-in, 4/2 2x)	G01 (M5 female 2x)
	S04 (push-in, 6/4 2x)	G06 (M7 female 2x)
	S07 (push-in, 4/2 3x)	G07 (M5 female 3x)
	S08 (push-in, 6/4 2x, 4/2)	G08 (M7 female 2x, M5 female)
	S09 (push-in, 4/2, 6/4 2x)	G09 (M5 female, M7 female 2x)
Suction valve control	NO (normally open), sucks when no voltage is applied NC (normally closed), does not suck when no voltage is applied	
Electrical connection	M8 plug, 6-pole	
Individual configuration code	The 3-digit code "AAA" uniquely describes an ejector disk.	

3.3 Ejector Structure

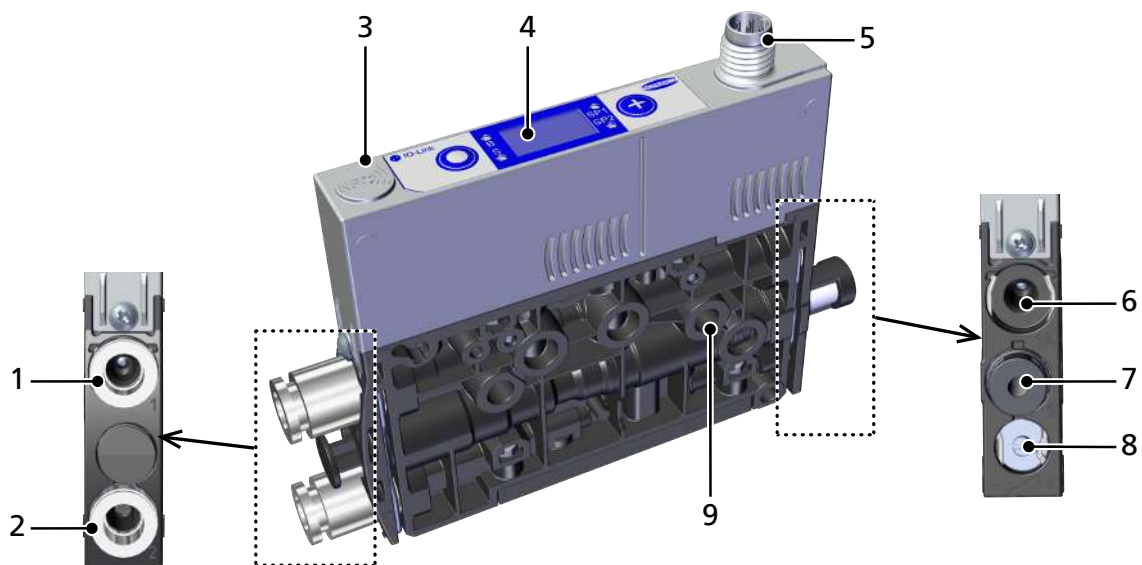

1	Compressed air connector (marking 1)	2	Vacuum connection (marking 2)
---	--------------------------------------	---	-------------------------------

3	NFC symbol (product is equipped with an NFC interface)	4	Operating and display elements
5	M8 electrical connection, 6-pole	6	Optional: Compressed air connector for external blow off EB (marking 1A)
7	Silencer (marking 3)	8	Valve screw for blow off volume flow
9	2x mounting hole		

3.4 Controls and Displays in Detail

The ejector is fitted with the following elements to ensure simple operation:

- 2 buttons on the foil keypad
- A 3-digit display
- 4 light-emitting diodes (LEDs) as status indicators

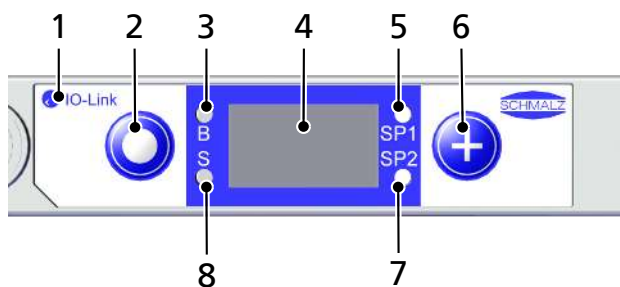

1	IO-Link symbol (product is equipped with an IO-Link interface)	2	MENU BUTTON
3	LED B for blow off state	4	Display
5	LED for switching point limit value SP1	6	PLUS BUTTON
7	LED for switching point limit value SP2	8	LED S for suction state





Definition of the LED indicators

The "suction" and "blow off" process states are each assigned an LED.

Item	Meaning	State	Description
3	Blow off LED B	OFF	Ejector not blowing off
		lit up	Ejector blowing off
8	Suction LED S	OFF	No suction from ejector
		lit up	Suction from ejector

The LEDs for the switching points SP1 and SP2 (limit values) indicate the current level of the system vacuum relative to the configured limit values. Their behavior is independent of the control function and the assignment of the output.

The table below explains the meaning of the LEDs:

Item	Limit value LEDs	Ejector state
5 and 7		LEDs both off Rising vacuum: vacuum < SP2 Falling vacuum: vacuum < rP2
5 and 7		SP2 LED lit steadily Rising vacuum: vacuum > SP2 and < SP1 Falling vacuum: vacuum > rP2 and < rP1
5 and 7		Both LEDs lit steadily Rising vacuum: vacuum > SP1 Falling vacuum: vacuum > rP1
5 and 7		Both LEDs flashing Manual control of the "suction" and "blow off" ejector functions. The ejector is in manual mode or setting mode.

4 Description of the Ejector

4.1 Suction of the Workpiece (Vacuum Generation)

The ejector is designed for vacuum handling of airtight parts in combination with suction systems. The vacuum is generated in a nozzle according to the Venturi principle, i.e. by using suction generated by the flow of accelerated compressed air. Compressed air is channeled into the ejector and flows through the nozzle. A vacuum is generated immediately downstream of the motive nozzle; this causes the air to be sucked through the vacuum connection. The air and compressed air that have been removed by the suction exit together via the silencer.

The venturi nozzle on the ejector is activated and deactivated using the suction command:

- In the NO (normally open) variant, the venturi nozzle is deactivated when the suction signal is received.
- In the NC (normally closed) variant, the venturi nozzle is activated when the suction signal is received.

An integrated sensor records the vacuum generated by the venturi nozzle. The exact vacuum level is shown on the display and can be read from the IO-Link process data.

The diagram below shows the vacuum curve for when the air saving function is activated:

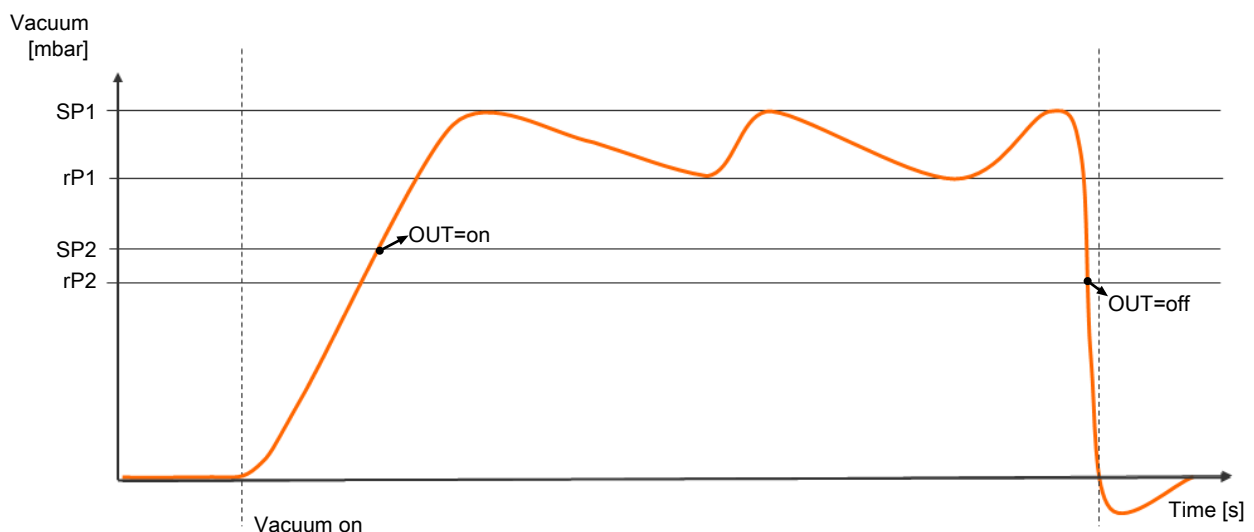

The ejector has an integrated air saving function and automatically regulates the vacuum in suction mode:

- The electronics switch the venturi nozzle off as soon as the vacuum limit value set for switching point SP1 is reached.
- When objects with airtight surfaces are picked up, the integrated non-return valve prevents the vacuum from dropping.
- If leakages cause the system vacuum to drop below the limit value configured for the switching point rP1, the venturi nozzle is switched back on.
- The OUT output is set once a workpiece is picked up securely, based on the vacuum value. This enables the further handling process.

4.2 Depositing the Workpiece/Part (Blowing Off)

In blow off mode, the vacuum circuit of the ejector is supplied with compressed air. This ensures that the vacuum drops quickly, allowing the workpiece to be quickly deposited.

During blow off, [-FF] is shown on the display.

The ejector provides two blow off modes for selection:

- Externally controlled blow off
- Internally time-controlled blow off

5 Technical Data

5.1 Display Parameters

Parameter	Value	Unit	Note
Display	3	Digit	Red 7-segment LED display
Resolution	±1	mbar	--
Accuracy	±3	% FS	T _{amb} = 25°C, based on FS final value (full-scale)
Display refresh rate	5	1/s	Only affects the 7-segment display
Idle time before the menu is exited	1	min	The display mode is accessed automatically when no settings are made in a menu.

5.2 General Parameters

Parameter	Type	Symbol	Limit value			Unit	Note
			min.	typ.	max.		
Working temperature		T _{amb}	0	—	50	° C	—
Storage temperature		T _{Sto}	-10	—	60	° C	—
Humidity		H _{rel}	10	—	85	% r.h.	Free from condensation
Degree of protection		—	—	—	IP40	—	—
Operating pressure (flow pressure)	03	P	2	4	6	bar	—
	05, 07 and 10	P	3	4	6	bar	—
Operating medium	Air or neutral gas, filtered to 5 µm, without oil, class 3-3-3 compressed air quality in acc. with ISO 8573-1						

5.3 Electrical Parameters

Supply voltage	DC 24 V ± 10% (PELV ¹⁾)		
Polarity reversal protection	Yes		
Current consumption (at 24 V)	—	Typical current consumption	Max. current consumption
	SCPMi – xx – NC	50 mA	70 mA
	SCPMi – xx – NO	75 mA	115 mA
NFC	NFC Forum Tag type 4		
IO-Link	IO-Link 1.1 Baud rate COM2 (38.4 Kbits/s)		

¹⁾ The power supply must correspond to the regulations in accordance with EN60204 (protected extra-low voltage).

5.4 Mechanical Data

5.4.1 Performance Data

Type	Nozzle 03	Nozzle 05	Nozzle 07	Nozzle 10
Nozzle size [mm]	0.3	0.5	0.7	1.0
Degree of evacuation [%]	87			
Max. suction rate [l/min] ¹⁾	2.2	7.5	15	28
Air consumption for suction [l/min]	3.5	9	22	45
Air consumption for blow off [l/min]	10			
Sound pressure level, unobstructed suction [dB(A)] ¹⁾	51	66	70	71
Sound pressure level, suction [dB(A)]	42	55	70	72
Pressure range [bar]	2 to 6		3 to 6	
Rec. diameter of compressed air hose [mm] ²⁾	2			4
Rec. diameter of vacuum hose [mm] ²⁾	2			4
Weight [g]	80	85		

¹⁾ At optimal operating pressure (SCPM...03/05/07: 4 bar; SCPM...10: 4.5 bar)

²⁾ For max. length of 2 m

5.4.2 Dimensions

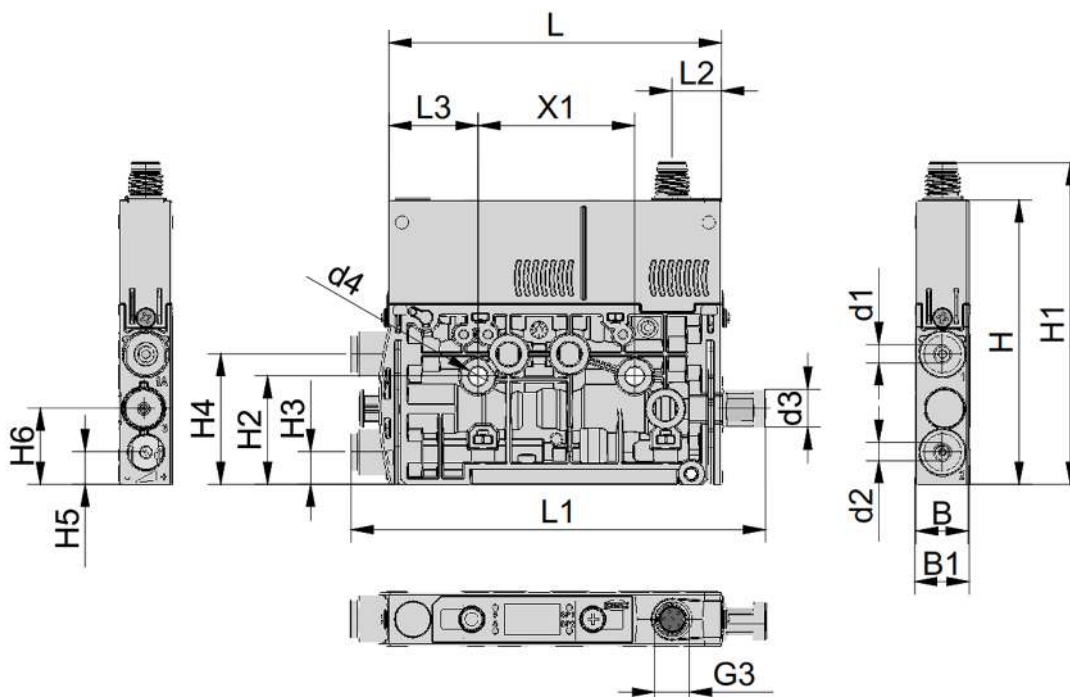

G3	L	B	H	L1	L2	L3	X1	H1	H2
M8x1 male thread	76.5	12	65.3	95.3	11.4	20.5	36	73.9	24.95

H3	H4	H5	H6	d1	d2	d5	d3	d4	B1
7.5	30	7.5	17.5	Depending on the particular ejector, see chapter 3.3 "Ejector designation"			9	4.3	12.5

All specifications are in mm

5.4.3 Maximum Torque

Connection	Max. torque
Mounting hole d4	1 Nm
Electrical connector G3	Hand-tight

5.4.4 Pneumatic circuit plans

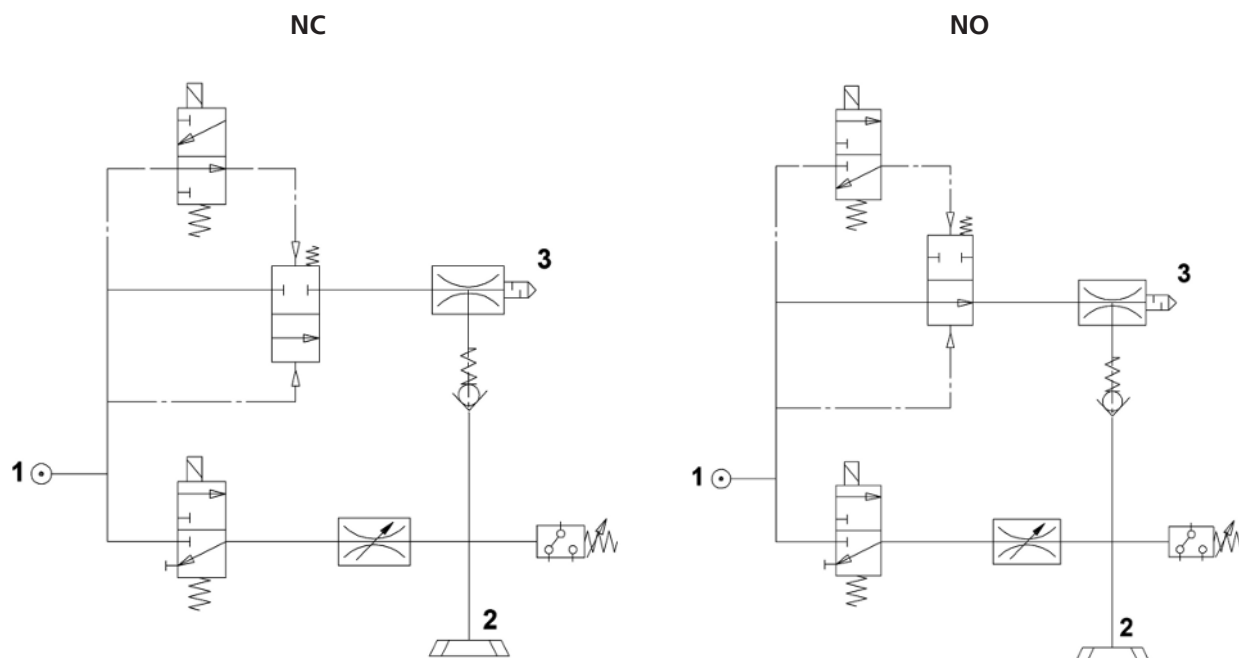

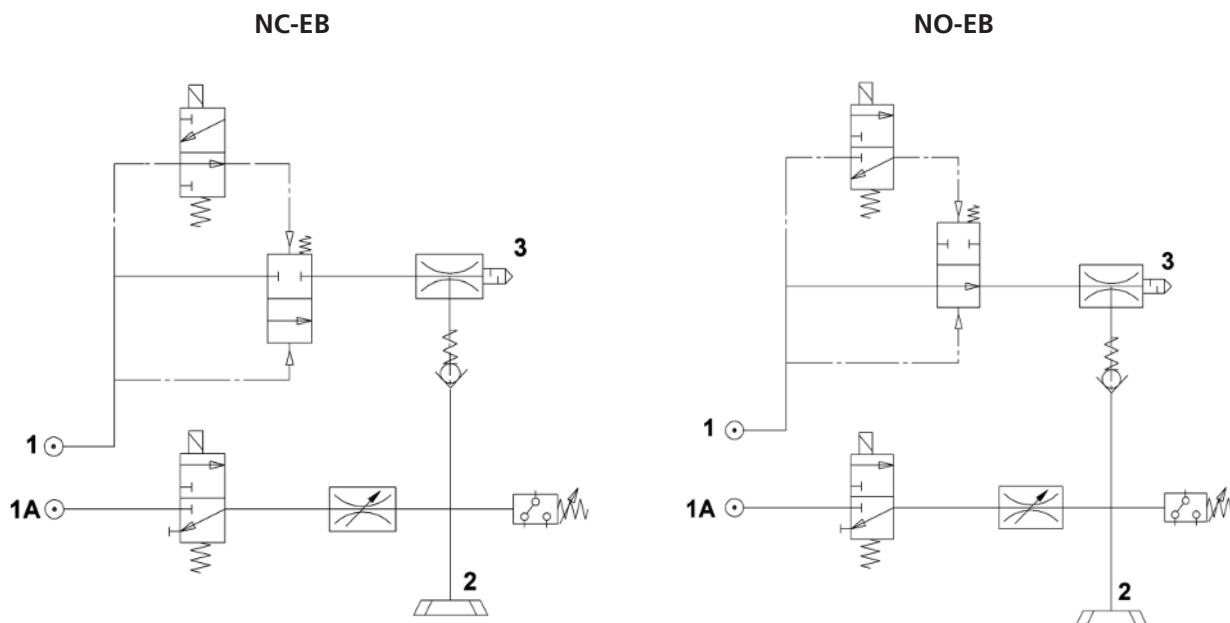

5.4.5 Factory Settings

Code	Parameter	Value of the factory setting
SP 1	Switching point SP1	750 mbar
rP 1	Reset point rP1	600 mbar
SP 2	Switching point SP2	550 mbar
rP 2	Reset point rP2	540 mbar
t _{bl}	Blow off time	0.20 s
c _{tr}	Control	Activated = ON
d _{cs}	Sustained suction	Deactivated = OFF
t ₋₁	Evacuation time	2.00 s
-L-	Leakage value	250 mbar/s
bl _o	Blow-off function	Externally controlled blow-off = -E-
ou ₂	Output function	Switching logic – output 2 = NO
P-n	Signal type	Output level = PNP
u _n	Vacuum unit	Vacuum unit in mbar = BAR
d _{ly}	Switch-off delay	10 ms
d _{py}	Display rotation	Standard = 5td
E _{co}	ECO mode	Deactivated = OFF
P _{in}	PIN code	User-defined 000

The production setup profiles P-1 to P-3 are factory-set to have the exact same data set as the default data set P-0.

6 Operating and Menu Concept

The ejector is operated using two buttons on the foil keypad:



MENU BUTTON



PLUS BUTTON

Navigation is divided into three menus:

- The main menu: for standard applications
- The Extended Functions (EF) menu: for applications with special requirements
- The Info menu (INF): for reading out system data such as counters, the software version, etc.

If settings are changed, undefined states of the system may occur for a short time (for approx. 50 ms).

The following information can be shown on the display:

- The current vacuum measurement value
- The selected menu item
- The settings
- Error messages in the form of error codes

The operating menu's home screen shows the currently measured vacuum level in the selected display unit. The available units are millibar, kilopascal, inHg and psi. The measured value is displayed as positive compared to the ambient air pressure.

The menus will automatically close if no buttons are pressed for 1 minute.

The display also returns to the home screen when an error occurs so that the error code can be displayed. A menu can be called up and used again afterward.

6.1 Button Assignments in Display Mode



In display mode, a specific function is assigned to each key.

6.1.1 Opening the Menu



Press the **PLUS BUTTON** to open the menus as follows:

- ▶ Press the  button briefly.
- ⇒ The main menu opens with the first parameter [SP l].

Opening the EF menu for extended functions:

1. Press the  button several times until the parameter EF appears on the display.
2. Press the  button to switch to the EF submenu for extended functions.
- ⇒ The EF menu opens with the first parameter [cEr].

Opening the INF menu:

1. Press the  buttons several times until the parameter InF appears on the display.
2. Press the  button to switch to the INF submenu for information.
- ⇒ The INF menu opens with the first parameter [cc l].

6.1.2 Displaying the Basic Settings (Slide Show)

When you press the  button from the home screen, the following parameters are automatically displayed one after the other on the display (slide show):

- The vacuum unit
- The current operating mode (S I□ or I□L)
- The currently activated production setup profile (P-0 to P-3)
- The value of switching point SP1
- The value of reset point rP1
- The value of switching point SP2
- The value of reset point rP2
- The supply voltage US

The display cycle returns to the vacuum display after a complete cycle or can be canceled at any time by pressing any button.

6.2 Main Menu

All settings for standard applications can be accessed and configured using the main menu.





6.2.1 Functions in the Main Menu





The following table shows an overview of the display codes and parameters in the main menu:

Display code	Parameter	Explanation
SP 1	Switching point 1	Value at which the control function deactivates (only active if [c b r] = [□□])
rP 1	Reset point 1	Reset value 1 for the control function
SP2	Switching point 2	Switching value for the "Parts control" signal
rP2	Reset point 2	Reset value 2 for the "Parts control" signal
t b L	Blow off time	Setting of the blow-off time for time-controlled blow-off
c AL	Zero-point adjustment (calibration)	Calibrate vacuum sensor, zero point = ambient pressure
EF	Extended functions	Open the "Extended Functions" submenu
INF	Information	Open the "Information" submenu
INC	Incorrect	The entered value is not within the permissible value range. This is an informational message that appears if incorrect information is entered.

6.2.2 Changing the Parameters of the Main menu

If you wish to change values, e.g. the switching points, you have to enter the new value digit by digit.

1. Use the  button to select the desired parameter.
2. Confirm using the  button.
 - ⇒ The currently set value is displayed and the first digit flashes.
3. Use the  button to change the value. The value increases by 1 each time the button is pressed. After 9, the counter goes back to 0 when the  button is pressed.

4. Press the  button to save the modified value.
⇒ The first digit is accepted and the second digit flashes.
5. Use the  button to set the second digit.
6. Press the  button to save the modified value.
⇒ The second digit is accepted and the third digit flashes.
7. Use the  button to set the third digit.
8. Press the  button to save the modified value.
⇒ If the value entered lies within the permissible value range, it is accepted and the modified parameter is displayed.
⇒ If the entered value does not lie within the permissible value range, this is briefly indicated on the display [1n] and the new value is not accepted.

If input is interrupted for longer than 1 minute or if no input is made, the display automatically switches to the measurement display.

6.3 Extended Functions menu (EF)

An “Extended Functions” menu (EF) is available for applications with special requirements.

6.3.1 Functions in the Extended Functions menu (EF)

The following table shows an overview of the display codes and parameters in the “Extended Functions” menu:









Display code	Parameter	Possible settings	Explanation
cEr	Energy-saving function	oFF oN oNS	Control function off Control active Control with leak monitoring active
dCS	Deactivate auto. control shutoff	no YES	Suppresses the automatic valve protection function when set to YES. Cannot be activated when cEr = oFF.
E - I	Max. permissible evacuation time	configurable between 0.01 and 9.99 seconds in steps of 0.01 oFF	Permitted evacuation time No monitoring
-L-	Max. permissible leakage	Values configurable between 0 and 999	Permitted leakage Unit: millibar per second
bLo	Blow-off function	-E- I-E E-E	Externally controlled Internally controlled (triggered internally, time can be set) Externally controlled (triggered externally, time can be set)
ouZ	Output function	no nC	Normally open contact [no] Normally closed contact [nC]
P-n	Output type	PnP nPN	Output PNP switch NPN switch

Display code	Parameter	Possible settings	Explanation
dLY	Switching signal delay	Values configurable between 0 and 999	Delay between switching signals SP1 and NP2 in milliseconds
uNt	Vacuum unit	mBar kPa inHg PSI	Define the displayed vacuum unit Vacuum level in millibar [mbar] Vacuum level in kilopascal [kPa] Vacuum value in inches of mercury [inHg] Vacuum value in pound-force per square inch [psi]
dIS	Display rotation	Std rot	Display configuration Standard rotated 180°
ECO	Display in ECO mode	off Lo on	Configure the display ECO mode is deactivated – the display remains on The brightness is reduced by 50 percent. Eco mode activated – if no buttons are pressed, the display turns off after one minute
PIn	PIN code	Value from 001 to 999	Specify the PIN code, lock the menus If the PIN code is 000, then the device is not locked.
nFc	NFC lock	on dIS Loc	NFC lock: NFC active Completely switched off Write-protected
rES	Reset	YES	The values remain unchanged Reset parameter values to factory settings

6.3.2 Changing parameters in the Extended Functions menu

Depending on the parameter, there are two different methods for entering values in the EF menu.





When entering numerical values, you enter them digit by digit as in the main menu:

1. Use the  button to select the desired parameter.
2. Confirm using the  button.
 - ⇒ The currently set value is displayed and the first digit flashes.
3. Use the  button to change the value. The value increases by 1 each time the button is pressed.
 - After 9, the counter goes back to 0 when the  button is pressed.
4. Press the  button to save the modified value.
 - ⇒ The first digit is accepted and the second digit flashes.
5. Use the  button to set the second digit.
6. Press the  button to save the modified value.
 - ⇒ The second digit is accepted and the third digit flashes.
7. Use the  button to set the third digit.

8. Press the  button to save the modified value.
 - ⇒ The value is accepted and the modified parameter is displayed.

If input is interrupted for longer than 1 minute or if no input is made, the display automatically switches to the measurement display.

For other parameters, you can select among predefined settings:

1. Use the  button to select the desired parameter.
2. Confirm using the  button.
 - ⇒ The current setting is displayed and flashes.
3. Use the  button to switch to the next setting.
4. Press the  button to save the desired setting.
 - ⇒ The selected setting is briefly shown on the display.
 - ⇒ The display then automatically jumps to the parameter that was just set.

6.4 Info menu [INF]

The “Info” [INF] menu is available for reading out system data such as counters, the software version, part numbers and serial numbers.

6.4.1 Functions in the Info menu

The following table shows an overview of the display codes and parameters in the Info menu:

Display code	Parameter	Explanation
cc 1	Counter 1	Counter for suction cycles (suction signal input)
cc 2	Counter 2	Valve switching cycles
cc 3	Counter 3	CM counter
ct 1	Erasable counter 1	Counter for suction cycles (suction signal input)
ct 2	Erasable counter 2	Valve switching cycles
ct 3	Erasable counter 3	CM counter
rc t	Reset erasable counters	All erasable counters reset to zero
Soc	Software	Indicates the software version
Part	Part number	Part number displayed
Snr	Serial number	Serial no. displayed, provides information about the production period



6.4.2 How Data is Displayed in the Info Menu

Counter values or numbers with more than 3 digits are displayed in a special manner.

Counter values and serial numbers are 9-digit whole numbers. These numbers are divided into 3 blocks of 3 numbers when shown on the display. Each time a decimal point is displayed to indicate if it is the highest, middle or lowest block. The display starts with the 3 highest-value digits and can be scrolled through

using the  button.

1. Use the  button to select the desired parameter.

2. Confirm using the  button.
3. Use the  button to display or scroll through the blocks that make up the value.

7 Interfaces

7.1 Basic Principles of IO-Link Communication

The ejector is operated in IO-Link mode to enable intelligent communication with a controller.

The IO-Link communication takes place using cyclical process data and acyclical ISDU parameters.

The ejector's parameters can be set remotely using IO-Link mode. In addition, the energy and process control (EPC) feature is available. The EPC is divided into 3 modules:

- Condition monitoring (CM): Condition monitoring to increase system availability
- Energy monitoring (EM): Energy monitoring to optimize the vacuum system's energy consumption
- Predictive maintenance (PM): Predictive maintenance to increase the performance and quality of the gripping systems

7.2 Process Data

The cyclical process data is used to control the ejectors and receive current information reported from the ejector. There is a difference between the input data (Process Data In) and the controlling output data (Process Data Out).

The input data Process Data In is used to report the following information cyclically:

- The limit values SP1 and SP2
- The status of SP3
- The ejector device status in the form of a status traffic light
- EPC data
- Warnings issued by the ejector
- Sensor supply voltage
- Air consumption

The output data Process Data Out is used to control the ejector cyclically:

- EPC Select is used to define which data is sent.
- To determine the air consumption, the system pressure can be preset.
- The ejector is controlled using the suction and blow-off commands.

The exact meaning of the data and functions is described in more detail in the "Description of Functions" chapter. A detailed description of the process data can be found in the data dictionary.

The corresponding device description file (IODD) is available for integration into a higher-level controller.

7.3 ISDU Parameter Data

The acyclical communication channel can be used to retrieve what are known as ISDU (Index Service Data Unit) parameters, which contain further information on the system status.

The ISDU channel can also be used to read or overwrite all the settings, e.g. the limit values, additional leakage, etc. Further information on the identity of the ejector, such as the part number and serial number, can be retrieved using the IO-Link. The ejector also provides space for saving user-specific information here, such as the installation and storage location.

The exact meaning of the data and functions is described in more detail in the "Description of Functions" chapter.

You can find a detailed diagram of the process data in the data dictionary and IODD.

In order for a control system to access the ISDU parameters, the necessary system functions must be purchased from the manufacturer of the control system and used.

7.4 Near Field Communication (NFC)

NFC (Near Field Communication) refers to a standard for wireless data transfer between different devices over short distances.

The ejector functions as a passive NFC tag that can be read or written by a read or write device which has NFC activated, such as a smartphone or tablet. Access to the ejector parameters via NFC also works when the supply voltage is not connected.

There are two options for communicating via NFC:

- Read access only can be obtained via a website viewed in a browser. For this, no additional app is needed. It requires only that NFC and the Internet connection are enabled.
- Another option for communication is the "Schmalz ControlRoom" control and service app. This permits not only read access, but also active reconfiguration of the parameters via NFC. The Schmalz ControlRoom app is available at the Google Play Store.

For the best data connection, place the reading device on the NFC symbol in the middle of the ejector.

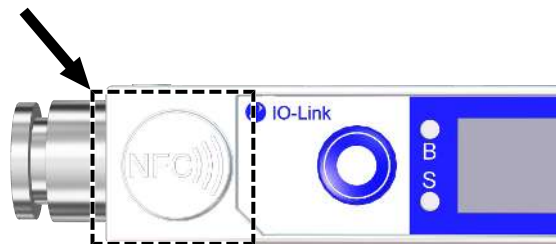

The reading distance is very short for NFC applications. Determine the position of the NFC antenna in the reading device used. If parameters of the device are modified via IO-Link or NFC, then the power supply must subsequently remain stable for at least three seconds to prevent data loss (error E01).

8 Description of Functions

8.1 Operating Modes

8.1.1 Automatic Operation

Once the ejector is connected to the power supply, it is ready for operation and enters automatic operation mode. This is the normal operating mode, in which the ejector is operated by the system controller.

The operating mode may be changed from automatic to manual mode using the buttons.

Parameterization of the ejector is always performed in automatic operation mode.

8.1.2 Manual Mode



NOTE

Change the output signals in manual mode

Personal injury or damage to property

- ▶ Electrical connection may be performed only by specialists who can evaluate the effects of signal changes on the overall system.

In manual mode, the "suction" and "blow-off" ejector functions can be controlled independently of the higher-level controller using the buttons on the foil keypad of the operating element. This function is used, among other things, to detect and eliminate leakages in the vacuum circuit.

In this operating mode, the "SP1" and "SP2" LEDs both flash.

Activating Manual Mode



NOTE

Manual mode modified by external signals

Personal injury or damage to property due to unpredictable work steps

- ▶ Ensure that the danger zone of the system is clear of people during operation.



NOTE

It is not possible to activate manual mode.

Access to manual mode is locked by the controller. This status is indicated by the code E90 on the display.

- ▶ Unlock manual mode using the controller.

✓ The ejector is on the measurement screen.

- ▶ Press and hold the  and  buttons simultaneously for at least 3 seconds.

⇒ The "SP1" and "SP2" LEDs flash.

Deactivating Manual Mode

✓ The ejector is in "manual mode".

- ▶ Briefly press the  and  buttons at the same time.

⇒ The SP1 and SP2 LEDs cease to flash.



The device also exits manual mode when the status of the external signals changes. When the ejector receives an external signal, it switches to automatic mode.

Activating and Deactivating Manual Suction

Activating manual suction



- ✓ The ejector is in "manual mode". The SP1 and SP2 LEDs flash.
- ▶ Press the  button to activate "suction" mode.
- ⇒ The suction LED S lights up.
- ⇒ The ejector begins to suck.

Deactivating manual suction

- ✓ The ejector is in "suction" mode.
- ▶ Press the  button again.
- ⇒ The suction process is deactivated.
- ▶ Alternatively, press the  button.
- ⇒ The ejector changes to the "blow-off" state for as long as you press the button.

 If the controller is on [CET] = [ON] it uses the configured limit values in "manual" mode as well.

Activating and Deactivating Manual Blow-off

- ✓ The ejector is in "manual mode".
- ▶ Press and hold the  button.
- ⇒ The blow-off LED B lights up.
- ⇒ The ejector blows off as long as the button is pressed.
- ▶ Release the  button to end the blow-off.
- ⇒ The blow off process is deactivated.
- ⇒ The blow-off LED B is no longer lit.

8.1.3 Setting Mode

Setting mode is used for locating and eliminating leakages in the vacuum circuit. Since the valve protection function is deactivated and the control is not deactivated, even at increased control frequencies.

In this operating mode, the "SP1" and "SP2" LEDs both flash.

Setting Mode Activated and Deactivated

- ▶ Set the corresponding value using bit 2 in the output process data byte (PDO).

A change to bit 0 or bit 1 (suction or blow-off) in the PDO also causes the ejector to exit setting mode.

This function is only available in IO-Link mode.

8.2 Monitoring the System Vacuum and Defining Limit Values

The ejector has integrated sensors for measuring the vacuum.

The current vacuum and pressure levels are shown on the display and can be read out via IO-Link.

The limit values are set in the main menu using the parameters [SP 1], [rP 1], [SP2] and [rP2] or IO-Link.

Limit values SP1 and rP1 are used by the control function to control the vacuum.

Limit value SP3, "Part deposited" [PDIN0] cannot be set using the main menu. It is fixed at 20 mbar. Signal SP3 is issued when the vacuum reaches < 20 mbar (providing the vacuum has already reached SP2 once).

By issuing this signal, the ejector tells the control system that the part has been deposited successfully. The signal is reset by issuing a new Suction ON command.

Overview of the limit values:

ISDU [Hex]	Limit value parameter	Description
P-0: 0x0064	SP1	Vacuum control value Vacuum switching point
P-0: 0x0065	rP1	Vacuum hysteresis Vacuum reset point
P-0: 0x0066	SP2	Activation value of "Parts control" signal output
P-0: 0x0067	rP2	Deactivation value of "Parts control" signal output
—	SP3	Part deposited (vacuum < 20 mbar)

8.3 Calibrating the Vacuum Sensor [0x0002]





Since the sensor integrated in the ejector is subject to variation due to the manufacturing process, we recommend calibrating the sensor after installation. In order to calibrate the ejector, the system's pneumatic circuits must be open to the atmosphere.

A zero offset is only possible in the range of ± 3 percent of the end value of the measuring range.

If the permissible limit of $\pm 3\%$ is exceeded, error code [E03] will appear on the display.

The function for zero-point adjustment of the sensor is performed in the basic menu under the parameter $\square \overline{AL}$ or using IO-Link.

Calibrating from the Main Menu:

1. To adjust the zero point, press the  button several times until [$\square \overline{AL}$] appears on the display.
 2. Confirm using the  button.
 3. Use the  button to choose between [OK] and [YES] (calibrate the vacuum sensor).
 4. Confirm using the  button.
- ⇒ The sensor is calibrated.

8.4 Control Functions [P-0: 0x0044]

The ejector allows you to conserve compressed air or prevent a too powerful vacuum from being generated. Vacuum generation is interrupted once the configured switching point SP1 is reached. If leakage causes the vacuum to fall below the reset point rP1, vacuum generation resumes.

The **permitted leakage** can be set in mbar/s using the [$\square \overline{L}$] parameter in the Extended Functions menu. The leakage is measured from the point when the control function interrupts suction after reaching switching point SP1.

The following operating modes can be set for the controller function in the EF menu using the [cbr] parameter or via IO-Link.

8.4.1 No Control (Continuous Suction)

The ejector produces continuous suction with maximum power. This setting is recommended for very porous workpieces, which would otherwise cause the vacuum generator to switch on and off continuously due to the high rate of leakage.

For this mode, the control function is set to [cbr] = [OFF].

This setting can only be adjusted when the control shutoff is deactivated [dcs] = [no].

8.4.2 Control

The ejector switches off vacuum generation when the switching point SP1 is reached and switches it back on when the vacuum falls below the reset point rP1. The switching point evaluation for SP1 follows the control function. This setting is particularly recommended for airtight workpieces.

For this mode, the control function is set to [cbr] = [on].

To protect the ejector, valve switching frequency monitoring is activated in this operating mode.

If the readjustment is too fast, the control function is deactivated and the device switches to continuous suction.

8.4.3 Control with Leak Monitoring

This operating mode is the same as the previous mode, with the addition that the leakage rate within the system is measured and compared to the configurable limit value for permissible leakage -L-.

If the actual leakage rate exceeds the limit value more than twice in succession, the control function is then deactivated and the ejector switches to continuous suction.

In this mode, the control function is set to [cbr] = [on].

8.4.4 Control Shutoff [P-0: 0x004E]

This function deactivates the automatic control shutoff.

The function can be set using the parameter [dcs] in the EF menu or via IO-Link.

Parameter	Setting value	Explanation
dcs	[no]	If excessive leakage is detected and the valve is switching too often (> 6 times in 3 seconds), the ejector switches to "continuous suction" mode
	[yes]	Continuous suction is deactivated and the ejector continues controlling in spite of the high leakage or having a switching frequency of > 6 times in 3 seconds. Continuous suction will not be activated if the valve frequency is exceeded.



When the control shutoff is deactivated, the suction valve makes frequent adjustments. This can destroy the ejector.

8.5 Blow-Off Modes [0x0045]

The following three blow-off modes are available. The function can be set with the parameter [blo] in the extended functions menu or via IO-Link.

8.5.1 Externally controlled blow-off

The "blow-off" valve is controlled directly by the "blow off" command. The ejector switches to blow-off mode for as long as the "Blow-off" signal is present. The "Blow-off" signal is given priority over the "Suction" signal.

In this mode, the blow-off function is set to [E-].

8.5.2 Internally time-controlled blow-off

In this mode, the blow-off function is set to [I-].

The "blow-off" valve is automatically activated for the configured time period as soon as the ejector leaves "suction" mode. The blow-off time can be set with the parameter [tBL] in the main menu.

The "blow-off" signal overrides the "suction" signal, even if the specified blow-off time is very long.

8.5.3 Externally Time-Controlled Blow-Off

In this mode, the blow-off function is set to [E-].

The blow-off pulse is triggered externally by the "Blow-off" signal/command. The "Blow-off" valve is activated for the specified time [tBL]. A longer input signal does not increase the blow-off duration.

The "Blow-off" signal overrides the "Suction" signal, even if the specified blow-off time is very long.

The blow-off time can be set with the parameter [tBL] in the main menu.

8.5.4 Setting the Blow-Off Time [P-0: 0x006A]

If the blow-off function of the ejector is set to internally time-controlled [bL] = [I-] or externally time-controlled [bL] = [E-] "Blow-off", then the blow-off time [tBL] may be specified.

The blow-off time can be set using the [tBL] parameter in the main menu.

The value displayed indicates the blow off time in seconds. The time can range from 0.10 to 9.99 seconds.

8.6 Output function [0x0047]

The signal output can be switched between [NO] (normally open) and [NC] (normally closed) contact.

To switch this setting, use the [OU2] menu item in the extended functions menu, or IO-Link.

The function of the switching threshold SP2/rp2 (component check) is assigned to the Ou2 signal output.

8.7 Output type [0x0049]

The output type can be used to switch between PNP and NPN. To switch this setting, use the [PT] menu item in the EF menu, or IO-Link.

8.8 Selecting a Display Unit [0x004A]

The unit of the displayed vacuum level can be set using this function.

The function can be configured with the parameter [UN] in the EF menu or via IO-Link.

The following units are available:

Unit	Explanation
bar	The vacuum level is displayed in mbar. The setting for this unit is [BAR].
Pascal	The vacuum level is displayed in kPa. The setting for this unit is [kPA].
Inch of Hg	The vacuum level is displayed in inHg.

Unit	Explanation
	The setting for this unit is [$\text{H}\square$].
psi	The vacuum level is displayed in psi. The setting for this unit is [$\text{P}\square$].



Selection of the unit only affects the display. The units of the parameters that can be accessed via IO-Link are not affected by this setting.

8.9 Switch-Off Delay [0x004B]

You can use this function to set a switch-off delay for the SP1 and SP2 signals. This can be used to handle short drops in the vacuum circuit.

The duration of the switch-off delay can be set with the parameter [$\text{d}\square$] in the EF menu or via IO-Link. Select a value in the range from 0 to 999. To deactivate this function, enter the value [$\square\square\square$] (= off).

The switch-off delay affects the process data bits in IO-Link and the SP1 and SP2 status indicators.



8.10 Rotating the Display [0x004F]

To allow different installation positions, the orientation of the display can be rotated by 180° by changing the parameter [$\text{d}\text{P}\square$] in the EF menu or via IO-Link.

The factory setting is [$\text{S}\square$]. This corresponds to the standard configuration.

To rotate the display by 180°, select the parameter setting [\square].



The  and  still work as usual when the display has been rotated.

The decimal points of the display are shown on the top edge of the screen.

8.11 ECO Mode [0x004C]

The ejector offers the option of switching off the display or dimming it to save energy. If ECO mode is activated, the display is switched off to reduce system power consumption after 1 minute if no buttons are pressed.

ECO mode can be enabled and disabled with the parameter [$\text{E}\square$] in the EF menu or via IO-Link.

Three different settings are available:

- [$\square\text{F}\square$]: Energy-saving mode is disabled.
- [\square]: The brightness of the display is reduced by 50 percent after 1 minute.
- [\square]: The display switches off after one minute of inactivity.

In order to signal that the ejector is working properly, the left-hand decimal point is still displayed when the display is switched off.

The display is reactivated by pressing any button or by an error message.



If you activate ECO mode using IO-Link, the display will immediately enter energy-saving mode.

8.12 Locking and Unlocking the Menus

The menus can be protected from unwanted access by means of a PIN code [$\text{P}\square$] or in the IO-Link using Device Access Locks. The current settings are still displayed.

The PIN is set to 000 on delivery. The menus are not protected.



A PIN is recommended because carrying out parameterization while the device is in operation can change the status of signals.

8.12.1 PIN Code [0x004D]





To enable the lock, a valid PIN code between 001 and 999 must be entered in parameter [P 17] in the EF menu or via IO-Link.

If you attempt to alter a parameter while the lock is active, [L 00] will flash on the display and you will be asked to enter your PIN code.

The PIN code can be enabled and disabled with the parameter [P 17] in the EF menu or via IO-Link (value > 000).

The following describes how to set a PIN Code using the operating and display element.

✓ In the EF menu, select the parameter [P 17].

1. Press the  button.
⇒ The current PIN code will be displayed, and the digit on the right will flash.
2. Use the  button to enter the first digit of the PIN code.
3. Use the  to confirm and go to entry of the second digit.
4. Enter the remaining digits in the same way.
5. Press the  button to save the PIN code.
⇒ The menus are now locked.

If write protection is activated, the desired parameters can be changed within one minute after the correct code is entered. If no changes are made within one minute, write protection is automatically reactivated.



The PIN code "000" must be set for permanent deactivation of the lock.

Full access to the device is still possible via IO-Link even if a PIN is enabled. The current PIN can also be read out and changed/deleted (PIN = 000) via IO-Link.

8.12.2 Unlocking the Menus

Menus can be protected against unauthorized access by defining a PIN code [P 17] in the EF menu. If you attempt to alter a parameter while the lock is active, [L 00] will flash on the display, or you will be asked to enter your PIN code.

The menus can be unlocked as follows:

1. Use the  button to enter the first digit of the PIN code.
2. Use the  to confirm the first digit and go to entry of the second digit.
3. Repeat this process to enter all the digits of the PIN code.
⇒ When a valid PIN is entered, the message [L 00] is displayed.
⇒ When an invalid PIN is entered, the message [L 00] is displayed and the menus remain locked.
⇒ Once the PIN has been entered successfully, you will have one minute to edit the parameter in question.

The PIN code in the [P 17] parameter must be set to 000 in order to permanently deactivate the lock.

The PIN is set to 000 on delivery. The menus are not protected.



If you cannot remember the correct PIN code, read or reset the PIN code from the IO-Link, or use NFC to reset to factory settings.

8.13 Restricting Access Using Device Access Locks [0x000C]

In IO-Link mode, the "Device Access Locks" default parameter is available to prevent changes to parameter values using the operating element of the ejector.

A menu lock using the Device access locks parameter has a higher priority than the menu PIN. In other words, this lock cannot be bypassed by entering a PIN, and remains in place.

It can only be canceled using IO-Link, not on the ejector itself.

8.14 Restricting Access with Extended Device Access Locks [0x005A]

The Extended Device Access Locks gives you the following options:

- Block all NFC access or restrict it to read-only functions. The NFC lock using the extended device access locks parameter has a higher priority than the NFC PIN. That means that this lock also cannot be bypassed by entering a PIN.
- Block the use of manual mode.
- Block the transmission of IO-Link events.

8.15 Resetting to Factory Settings (Clear All) [0x0002]

This function is used to reset the following configurations to their factory settings:

- The configuration of the ejector
- The initial setup
- The production setup profile settings
- The IO-Link parameter "Application specific tag"

This function is executed using the parameter [rES] in the EF menu or via IO-Link.

The factory settings for the ejector are listed in the Technical Data section.







WARNING

By activating/deactivating the product, output signals lead to an action in the production process!

Personal injury

- ▶ Avoid possible danger zone.
- ▶ Remain vigilant.

A description of how to reset the ejector to factory settings using the display and operating element follows:

- ✓ The EF menu is open.
1. Use the  button to select the parameter [rES].
 2. Confirm using the  button.
 3. Use the  button to select [YES] for the parameter value.
 4. Confirm using the  button.
- ⇒ The ejector is reset to the factory settings.

The reset to factory settings function does not affect the following elements:

- The counter readings
- The zero-point adjustment of the sensor

8.16 Counters

The ejector has three internal, non-erasable counters and three erasable counters.

Counters 1 [cc 1] and [ct 1] increase with every valid "Suction" signal pulse, and thus count the ejector's suction cycles.

Counters 2 [cc 2] and [ct 2] count the suction valve's switching cycles, and counters 3 [cc 3] and [ct 3] count the CM events.

The average switching frequency can be determined using the difference between counters 1 and 2.

ISDU [Hex]	Display code/parameter	Function	Description
0x008C	cc 1	Counter 1	Counter for suction cycles (suction signal)
0x008D	cc 2	Counter 2	Counter for suction valve switching frequency
0x008E	cc 3	Counter 3	Counter for condition monitoring events
0x008F	ct 1	Counter 1, erasable	Counter for suction cycles (Suction signal) – erasable
0x0090	ct 2	Counter 2, erasable	Counter for suction valve switching frequency – erasable
0x0091	ct 3	Counter 3, erasable	Counter for condition monitoring events – erasable

The counters can be displayed or read out from the INF menu using the parameters listed in the table, or via IO-Link.

Calling up the Counter Values

- ✓ Select the counter you wish to see in the [INF] menu.
- ▶ Confirm the parameter by pressing the  button.
- ⇒ The first three decimal places of the counter total will be displayed (the digits x 10⁶). This corresponds to the three-digit block with the highest value.

Use the  button to display the remaining decimal places of the counter total, in order of descending value. The decimal points show which 3-digit block of the counter total is shown in the display.

The counter total is comprised of the 3-digit blocks taken together:

Displayed section	10 ⁶	10 ³	10 ⁰
Digit block	0.48	6 18	593





The current counter total in this example is 48 618 593.



Non-erasable counter readings are saved only every 1000 steps. That means that when the operating voltage is switched off, up to 999 steps of the counter are lost.

Erasing Counters [0x0002]

There are two different ways of resetting the erasable counters Ct1, Ct2 and Ct3 to 0:



- Using system commands via IO-Link
- Using the control panel:
 - ✓ The [IΠF] menu is open.
 - 1. Use the  button to select the parameter [Γ C E].
 - 2. Confirm using the  button.
 - 3. Use the  button to select [4 E 5] for the parameter value.
 - 4. Confirm using the  button.
 - ⇒ The erasable counters Ct1, Ct2 and Ct3 are set to 0.

8.17 Displaying the Software Version

The software version indicates the software currently running on the internal controller.



The system firmware can be updated using the "Firmware Update" profile defined by IO-Link. If necessary, this will also update the firmware for the valve module. The PD bit In Byte 1.2 signals when a more recent version is available in the supply module.

Using the control panel:

- ✓ The Info menu is open.
- 1. Use the  button to select the [5 0 0] parameter.
- 2. Confirm using the  button.
 - ⇒ The software ID is displayed.
- ▶ To exit the function, press the  button.

8.18 Displaying the Part Number [0x00FA]

The part number of the ejector is printed on the label and also stored electronically.

- ✓ The ejector is in the IΠF menu.
- 1. Use the  button to select the part number parameter A Γ E .
- 2. Use the  button to confirm the part number parameter A Γ E .
 - ⇒ The first two digits of the part number are displayed.
- 3. Press the  button again several times.
 - ⇒ The remaining digits of the part number are displayed. The decimal points shown are part of the part number.



In the first block displayed, the point on the far right (after the second digit), which is part of the part number, is not displayed for technical reasons.

The part number consists of 4 blocks with a total of 11 digits.

Displayed section	1	2	3	4
Digit block	10	020	200	383



The part number in this example is 10.02.02.00383.

- ▶ To exit the function, press the  button.

8.19 Displaying the Serial Number [0x0015]

The serial number indicates the production period of the ejector.

- ✓ The ejector is in the Info menu INF

1. Use the  button to select the serial number parameter Snr.
2. Use the  button to confirm the serial number parameter Snr.
 - ⇒ The first three decimal places of the serial number will be displayed (the digits x 10⁶). This corresponds to the three-digit block with the highest value.
3. Press the  button again several times.
 - ⇒ The remaining digits of the serial number are displayed. The decimal points show which 3-digit block of the serial number is shown in the display.

The serial number consists of 3 blocks with a total of 9 digits:

Displayed section	10 ⁶	10 ³	10 ⁰
Digit block	900	000	000

In this example, the serial number is: 900000000

- ▶ To exit the Info menu, press the  button.

8.20 Device Data

The ejector provides a range of identification data that can be used to uniquely identify a device.

The following parameters can be queried via IO-Link or NFC:

- Manufacturer's name and website
- Supplier text
- Product name and product text
- Serial number
- Version status of the hardware and firmware
- User ID
- Unique device ID and device characteristics
- Part number and development status
- Manufacture and installation date
- Location ID
- System Configuration
- Device ID
- Web link for NFC app device description file
- Storage ID

8.21 User-Specific Localization

The following parameters are available for the ejector when saving user-specific information:

- Equipment labeling from the circuit diagram
- Geo-location
- IODD web link
- NFC web link
- Installation date
- Identification of the storage location
- Identification of the installation location

The parameters are ASCII character strings with the maximum length given in the data dictionary. The addresses can also be used for other purposes if necessary.

The NFC web link parameter is a special feature. This parameter must include a valid web address beginning with `http://` or `https://` and is automatically used as a web address for NFC read accesses. As a result, read accesses from smart phones or tablets are rerouted e.g. to an address in the company's own intranet or a local server.

8.22 Process Data Monitoring

IO-Link provides the current measurements for the following parameters, plus the lowest and highest values measured since switching on:

- For the vacuum [0x0040]
- For the compressed air supply [0x0041]
- For the supply voltage [0x0042]

The maximum and minimum values can be reset using the appropriate system command [0x0002].



The ejector is not a calibrated measuring device. However, the values may be used as a reference and for comparison measurements.

8.23 Production Setup Profiles

In IO-Link mode, the ejector can store up to four different production setup profiles (P-0 to P-3). All important parameter data for workpiece handling is stored in these profiles. The profile is selected by means of the process data byte PDO byte 0. Thus parameters can be adjusted to suit differing process conditions.

The currently selected data set is displayed in the parameter data under "Production Setup." This data set corresponds to the current parameters the ejector is working with, which can be viewed using the menu.

You can view the parameter data set (P-0 to P-3) that is currently in use in the slide show by pressing the



button.

In the default setting, the P-0 production setup profile is selected.

Then menus can only be used to adjust the profile that is currently selected via IO-Link.

8.24 Energy and Process Control (EPC)

In IO-Link mode, the energy and process control (EPC) function is available. It is subdivided into three modules:

- Condition monitoring (CM): Condition monitoring to increase system availability
- Energy monitoring (EM): Energy monitoring to optimize the vacuum system's energy consumption
- Predictive maintenance (PM): Predictive maintenance to increase the performance and quality of the gripping systems

8.24.1 Condition Monitoring (CM) [0x0092]

Monitoring the Valve Switching Frequency

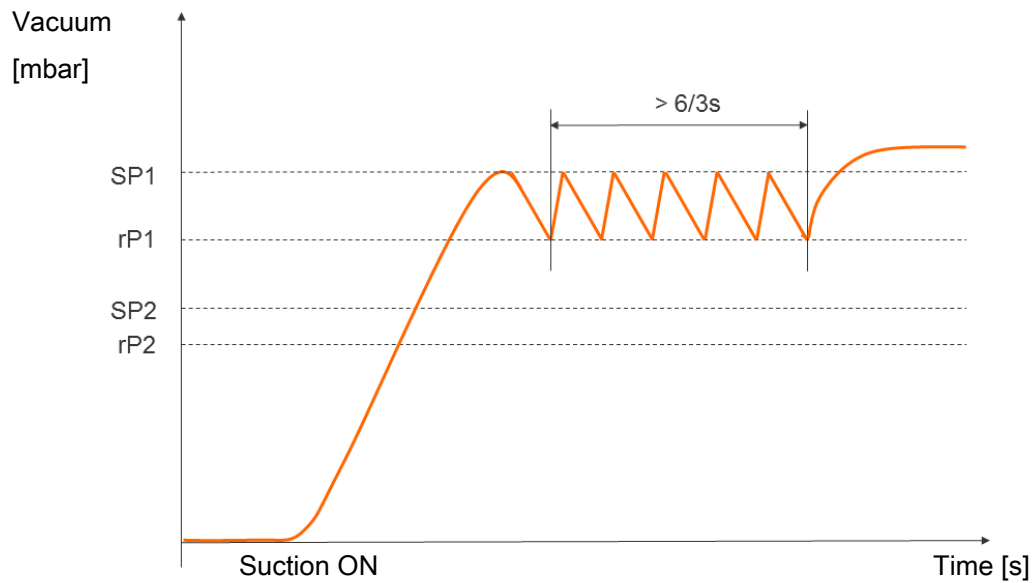

When the air saving function is activated and there is a high leakage level in the gripping system, the ejector switches between the Suction and Suction Off states very frequently. The number of valve switching procedures thus increases rapidly within a short time.

To protect the ejector and increase its service life, the ejector automatically deactivates the air saving function and switches to continuous suction if the switching frequency $> 6/3$ s (more than 6 switching operations within 3 seconds). In this case the ejector remains in the Suction state.

It also issues a warning and sets the corresponding condition monitoring bit.

Monitor Evacuation Time

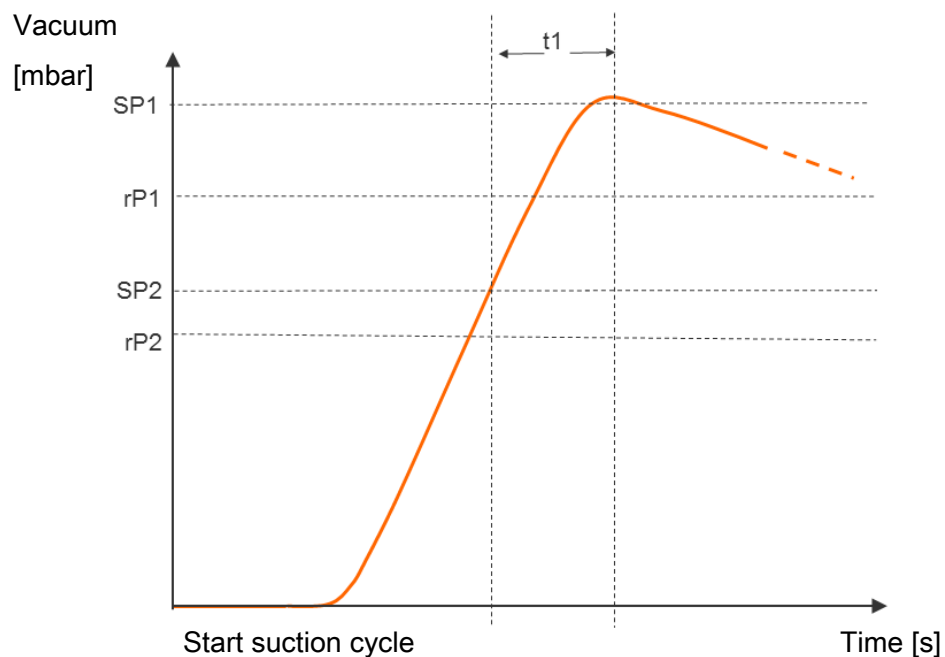

Measuring the evacuation time t_1 :

The interval between reaching the switching points SP2 and SP1 is measured (in ms).

If the measured evacuation time t_1 (from SP2 to SP1) exceeds the specified value, the "Evacuation time longer than t_1 " condition monitoring warning is triggered and the system status light switches to yellow.

The specified value for the max. permitted evacuation time can be set in the EF menu with the parameter [E-1] or via IO-Link [0x006B]. Setting the value to [000] (= off) deactivates monitoring. The maximum permitted evacuation time setting is 9.99 s.

Leakage monitoring

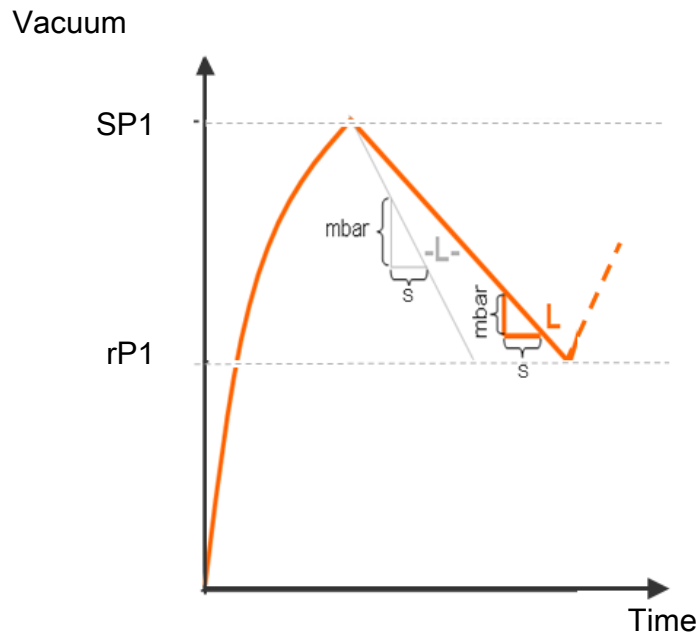

Measuring the leakage:

In control mode ([E-1] = [005] or [00]), the vacuum drop/leakage over a certain period of time is measured (as vacuum drop per time unit in mbar/s) after the air saving function has interrupted suction because switching point H1 has been reached.

The measured leakage value "L" in mbar/s can be queried via IO-Link.

Evaluating the Leakage Level

In control mode ([E-1] = [005]), the loss of vacuum within a certain period is monitored (mbar/s).

Evaluation of the leakage level differentiates between two states:

Leakage $L <$ permitted value -L-

- The vacuum continues to decrease until it reaches the reset point rP1
- The ejector begins to suck again (normal control mode)

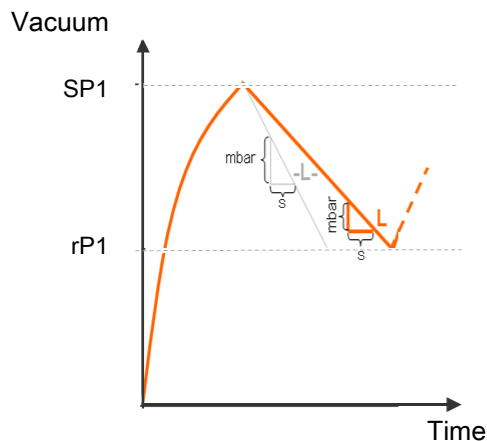
**Leakage $L >$ permitted value -L-**

- The ejector immediately begins to correct it
- A condition monitoring warning is activated
- The system status indicator light turns yellow

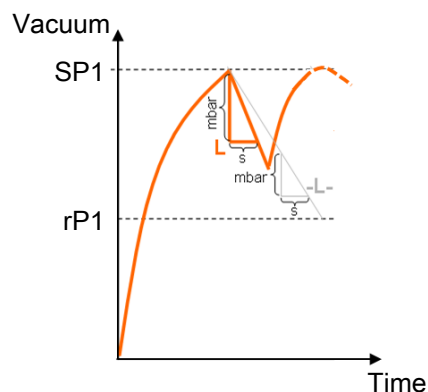

The specified value for the max. permitted leakage -L- is set in the EF menu using the parameter [-L-] or using IO-Link [0x006C]. The maximum leakage that can be set is 999 mbar/second.

Control Threshold Monitoring

If the switching point SP1 is never reached during the suction cycle, the "SP1 not reached" condition monitoring warning is triggered and the system status light switches to yellow.

This warning is available at the end of the current suction phase and remains active until the next suction cycle.

Monitor Dynamic Pressure

If possible, a dynamic pressure measurement is taken at the start of every suction cycle (vacuum during unobstructed suction). The result of this measurement is compared to the limit values set for SP1 and SP2.

If the dynamic pressure is greater than (SP2 - rP2) but less than SP1, the corresponding condition monitoring warning is triggered and the status light switches to yellow.

Monitoring the Supply Voltages

The ejector is not a voltage meter! However, the measured values and the system responses derived from them provide a helpful diagnostics tool for condition monitoring.

The ejector measures the supply voltages U_s . The measured value can be read from the parameter data.

If the voltages are outside the valid range, the following status messages change:

- Device status
- Condition monitoring parameter
- An IO-Link event is generated

Condition Monitoring Events and Status Display [0x0092]

Any condition monitoring events that occur during the suction cycle cause the system status indicator light to immediately switch from green to yellow/orange. The event that caused this switch can be seen in the "Condition monitoring" IO-Link parameter.

The table below explains the coding of the condition monitoring warnings:

Bit	Event	Update
0	Valve protection function activated	Cyclic
1	Set limit value t-1 for evacuation time exceeded	Cyclic
2	Set leakage limit value -L- exceeded	Cyclic
3	Limit value SP1 was not reached	Cyclic
4	Dynamic pressure > (SP2-rP2) and < SP1	As soon as a corresponding dynamic pressure value has been determined
5	Supply voltage U_s outside the operating range	Constant
8	Input pressure outside operating range	Constant

Bits 0 to 3 describe events that can only occur once per suction cycle. They are reset at the start of every suction cycle and remain stable until it has ended.

Bit number 4, which describes dynamic overpressure, is initially deleted when the device is switched on and is updated when a dynamic pressure value is detected.

Bits 5 and 8 are regularly updated independently of the suction cycle, and reflect the current values for the supply voltage and system pressure.

The values measured by the condition monitoring system, namely the evacuation times t_0 and t_1 and the leakage value L , are reset at the beginning of the suction process and updated once they have been measured.

8.24.2 Energy Monitoring (EM) [0x009B, 0x009C, 0x009D]

In order to optimize the efficiency of vacuum gripping systems, the ejector provides a function for measuring and displaying the energy and air consumption.

When measuring air consumption as a percentage, the ejector calculated the air consumption from the last suction cycle as a percentage. This value corresponds to the ratio for the full duration of the suction cycle and the active suction and blow-off times.

An externally recorded pressure value can be supplied using the IO-Link process data. If this value is available, absolute air consumption measurement can be performed in addition to the percentage-based air consumption measurement. The actual air consumption of a suction cycle is calculated taking the system pressure and nozzle size into account, and specified in standard liters [NL]. The measured value is reset at the beginning of the suction cycle and constantly updated during the running cycle. As such, no further changes can occur once blow-off is complete.

The electrical energy consumed by the device and by the valve coils during a suction cycle is measured and given in watt-seconds (Ws).

For determining the electrical energy consumption, the neutral phase of the suction cycle must also be considered. Therefore the measured values can be updated only when the next suction cycle begins. During the entire cycle, they represent the results from the previous cycle.



The ejector is not a calibrated measuring device. However, the values may be used as a reference and for comparison measurements.

8.24.3 Predictive Maintenance (PM)

Overview of Predictive Maintenance (PM)

In order to allow early detection of wear and other impairments to the vacuum gripping system, the ejector provides functions for recognizing trends in the quality and performance of the system. This is accomplished using the measured values for leakage and dynamic pressure.

The measurement value for the leakage rate and the related quality assessment in percent are reset at the start of every suction cycle and constantly updated during the cycle as moving averages. The values therefore remain stable until after the suction cycle is complete.

Measurement of Leakage

The control function interrupts suction as soon as it reaches the limit value SP1. Then the leakage is measured as the vacuum decrease over time (in mbar/s).

Dynamic Pressure Measurement

This measures the system vacuum achieved during unobstructed suction. The measurement length is approx. 1 s. Thus evaluation of a valid dynamic pressure value requires at least one second of unobstructed suction after the suction cycle has commenced. The suction point must not be occupied by a component at this time.

Measured values below 5 mbar or above the limit value SP1 are not regarded as valid dynamic pressure measurements and are discarded. The result of the last valid measurement is retained.

Measured values that are below the limit value SP1 but simultaneously above the limit value SP2 – rP2 result in a condition monitoring event.

The dynamic pressure and the percentage performance value based on it are initially unknown when the ejector is switched on. As soon as a dynamic pressure measurement can be performed, the dynamic pressure and the performance evaluation are updated and retain their values until the next dynamic pressure measurement.

Quality Assessment [0x00A2]

In order to evaluate the entire gripping system, the ejector calculates a quality rating based on the measured system leakage.

The greater the leakage in the system, the worse the quality rating of the gripping system. Conversely, low leakage results in a high quality rating.

Performance Calculation [0x00A3]

The performance calculation helps in evaluating the system status. The performance of the gripping system can be assessed based on the measurement of the dynamic pressure.

Optimal configuration of gripping systems leads to low dynamic pressure and thus to high performance. Conversely, badly configured systems achieve low performance.

Dynamic pressure events that exceed the limit value (SP2 – rP2) always result in a performance rating of zero percent. A dynamic pressure value of 0 mbar (which indicates that no valid measurement value could be obtained) also results in a performance rating of zero percent.

8.24.4 Reading the EPC Values

The results of the condition monitoring function are also available in the ejector's process input data. However, to ensure that the different pairs of values can be read using a controller program, the EPC-Select acknowledged bit is provided in the process input data.

Proceed as follows to read the EPC values:

1. Start with EPC-Select = 00.
2. Create the selection for the next value pair you require, e.g. EPC-Select = 01.

3. Wait until the EPC-Select acknowledged bit changes from 0 to 1.
 - ⇒ The transmitted values correspond to the selection you have created, and can be adopted by the control system.
4. Switch back to EPC-Select = 00.
5. Wait until the EPC-Select acknowledged bit is reset to 0.
6. Repeat the same procedure for the next value pair, e.g. EPC-Select = 10.

9 Transport and Storage

9.1 Checking the Delivery

The scope of delivery can be found in the order confirmation. The weights and dimensions are listed in the delivery notes.

1. Compare the entire delivery with the supplied delivery notes to make sure nothing is missing.
2. Damage caused by defective packaging or occurring in transit must be reported immediately to the carrier and J. Schmalz GmbH.

10 Installation

10.1 Installation Instructions



CAUTION

Improper installation or maintenance

Personal injury or damage to property

- ▶ During installation and maintenance, make sure that the ejector is disconnected and depressurized and that it cannot be switched on again without authorization.

For safe installation, the following instructions must be observed:

1. Use only the connections, mounting holes and attachment materials that have been provided.
2. Carry out mounting and removal only when the device is in an idle, depressurized state.
3. Pneumatic and electrical line connections must be securely connected and attached to the ejector.

10.2 Mounting

The ejector may be installed in any position.

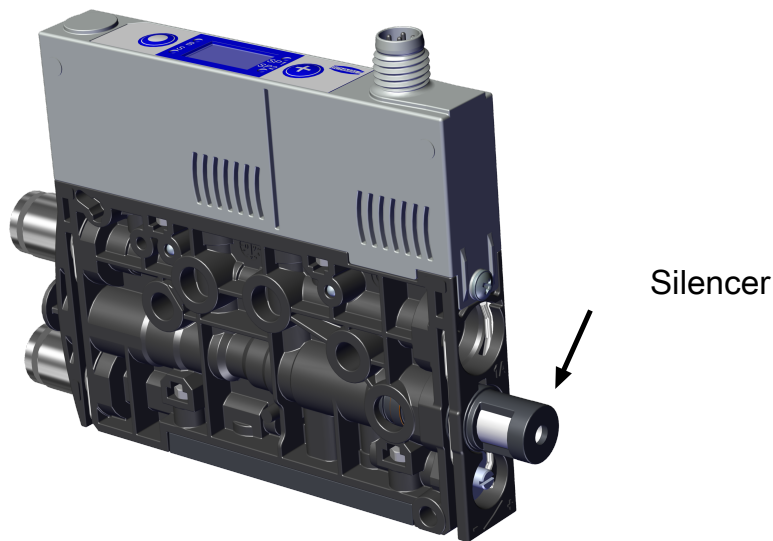

When installing the ejector, make sure that the area around the silencer remains free, so that unimpeded discharge of the escaping air is ensured.

The ejector is usually mounted using the holes on the side. Alternatively, it can be mounted using a DIN rail or a mounting bracket (> See *ch. Accessories, Page 60*):

Side mounting

- ▶ There are two 4.4 mm through-holes for mounting the ejector. Use screws at least 20 mm in length. Use washers if you are using fastening screws M4 for the mounting process. The ejector is to be fixed with at least 2 screws, the maximum tightening torque is 1 Nm.

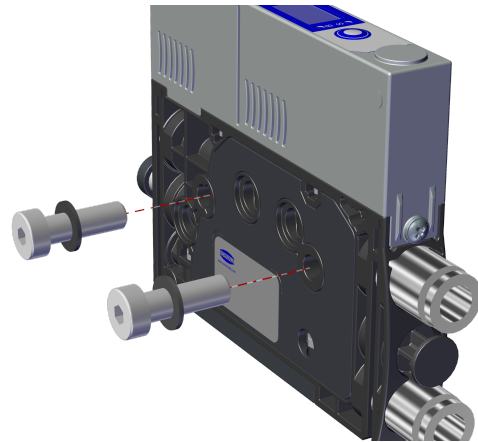

For start of operations, the ejector must be connected to the controller via the connection plug with a connection cable. The compressed air supply must be supplied by the higher-level machine.

The installation process is described and explained in detail below.

10.3 Pneumatic Connection



⚠ CAUTION

Compressed air or vacuum in direct contact with the eye

Severe eye injury

- ▶ Wear eye protection
- ▶ Do not look into compressed air openings
- ▶ Do not look into the silencer air stream
- ▶ Do not look into vacuum openings, e.g. suction cups



⚠ CAUTION

Noise pollution due to incorrect installation of the pressure and vacuum connections

Hearing damage

- ▶ Correct installation.
- ▶ Wear ear protectors.

10.3.1 Connecting the Compressed Air and Vacuum

Description of the Pneumatic Connector

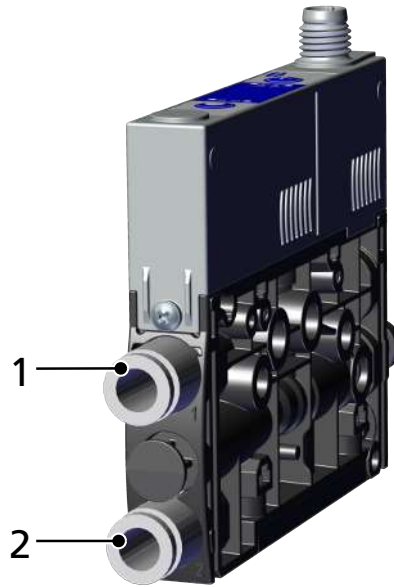

1	Compressed air connector (marking 1)	2	Vacuum connection (marking 2)
---	--------------------------------------	---	-------------------------------

The threaded or push-in compressed air connector is marked with the number 1 on the ejector.

- ▶ Connect compressed air hose. For threaded connectors, the maximum tightening torque is 1 Nm.

The threaded or push-in vacuum connection is marked with the number 2 on the ejector.

- ▶ Connect the vacuum hose. For threaded connectors, the maximum tightening torque is 1 Nm.

10.3.2 Instructions for the Pneumatic Connection

To ensure problem-free operation and a long service life of the ejector, only use adequately maintained compressed air and consider the following requirements:

- Use air or neutral gas in accordance with EN 983, filtered to 5 µm, unoled.
 - Dirt particles or foreign bodies in the ejector connections, hoses or pipelines can lead to partial or complete ejector malfunction.
1. Shorten the hoses and pipelines as much as possible.
 2. Keep hose lines free of bends and crimps.
 3. Use only pipes or hoses with the recommended inner diameter to connect the ejector:

Use hoses with sufficient internal diameter...

	Internal Ø for nozzle size 0.3 / 0.5 / and 0.7 mm	Internal Ø for nozzle size 1 mm
on the compressed air side to ensure that the ejector achieves its performance data.	4 mm	6 mm
on the vacuum side to avoid high flow resistance. If the internal diameter is too small, the flow resistance and the evacuation times increase and the blow off times are extended.	4 mm	6 mm

Internal diameters are based on a maximum hose length of 2 m.

10.3.3 Optional: External blow-off connection (EB)

The ejector is also available with an additional compressed air connector for the blow-off function.

With the external blow-off function (EB), the blow-off pulse is controlled separately and independently of the compressed air supply for vacuum generation, allowing you to use a different medium (e.g. nitrogen) for the blow-off function.

It also allows you to precisely set the blow off pressure using an external pressure regulator (between 2 and 6 bar).

The blow off flow rate can also be set between 0% and 100% directly on the ejector. This can be used, for example, to set down small and lightweight workpieces with high positioning precision.

The hose size and the thread on the connector depend on the particular ejector and can have the following dimensions:

- Push-in: 4/2
- Female thread M5

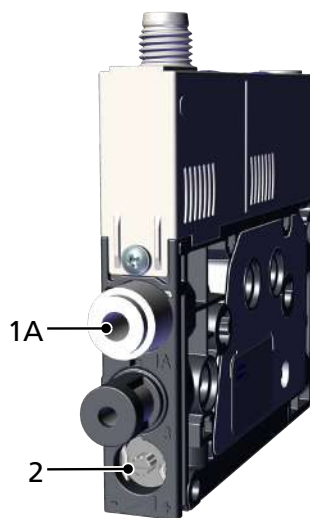

- ▶ Connect the compressed air hose for external blow-off (connector marked with 1A) and adjust the blow-off flow rate using the adjusting screw (2).

10.4 Electrical connection



NOTE

Change of output signals when product is switched on or plug is connected

Personal injury or damage to property

- ▶ Electrical connection may be performed only by specialists who can evaluate the effects of signal changes on the overall system.



NOTE

Incorrect power supply

Destruction of the integrated electronics

- ▶ Operate the product using a power supply unit with protected extra-low voltage (PELV).
- ▶ The system must incorporate safe electrical cut-off of the power supply in compliance with EN60204.
- ▶ Do not connect or disconnect the connector under tension and/or when voltage is applied.

The electrical connection supplies the ejector with power and communicates with the controller of the higher-level machine using defined outputs or via IO-Link.

Establish the ejector’s electrical connection using plug connector 1 as shown in the figure.

- ✓ Provide a connection cable with an M8 6-pole socket (customer’s responsibility).



- ▶ Attach the connection cable to the electrical connection point (1) on the ejector, max. tightening torque = hand-tight.

Ensure that the electrical cable does not exceed the maximum length of 20 meters.

10.4.1 Pin Assignments

M8 plug	Pin	Symbol	Wire color ¹⁾	Function
	1	US	Brown	24 V power supply
	2	IN1	White	“Suction” signal input
	3	GND	Blue	Ground
	4	OUT / CQ	Black	“Parts control” output (SP2) or IO-Link
	5	IN2	Gray	“Blow-off” signal input
	6	—	Pink	Not used

¹⁾ When using a Schmalz connection cable, part no. 21.04.05.00488 (see accessories)

11 Operation

11.1 Operation via IO-Link

When the ejector is operated in IO-Link mode (digital communication), the supply voltages, the ground and the communication cable for the IO-Link (C/Q cable) are connected directly to the IO-Link master (point-to-point connection). It is not possible to connect multiple C/Q lines to a single IO-Link master port.

Connecting the ejector via the IO-Link provides access to a number of additional ejector functions alongside the basic functions of suction, blow-off, feedback, etc. These additional functions are:

- Device Data
- Device status
- The current vacuum level
- Choice of four production profiles (production setup profiles P0 to P3)
- Errors and warnings
- Ejector system status display
- Access to all parameters
- Functions for energy and process control

So that all the modifiable parameters can be read directly via the higher-level controller, modified and written back to the ejector.

Evaluation of the condition monitoring and energy monitoring results allows you to draw direct conclusions regarding the current handling cycle and perform trend analysis. The ejector supports the IO-Link revision 1.1 with four bytes of input data and two bytes of output data. It is also compatible with IO-Link masters that use the 1.0 revision. In this case, one byte of input data and one byte of output data are supported. The exchange of process data between the IO-Link master and the ejector is cyclical. Parameter data (acyclical data) is exchanged by the user program in the controller using communication modules.

11.2 General Preparations



⚠ WARNING

Extraction of hazardous media, liquids or bulk material

Personal injury or damage to property!

- ▶ Do not extract harmful media such as dust, oil mists, vapors, aerosols etc.
- ▶ Do not extract aggressive gases or media such as acids, acid fumes, bases, biocides, disinfectants or detergents.
- ▶ Do not extract liquids or bulk materials, e.g. granulates.

Always carry out the following tasks before activating the system:

1. Before each use, check that the safety features are in perfect condition.
2. Check the ejector for visible damage and deal with any problems immediately (or notify your supervisor).
3. Ensure that only authorized personnel are present in the working area of the machine or system and that no other personnel are put in danger by switching on the machine.

There must be no people in the system danger area while it is in operation.

11.3 Changing the Blow-Off Flow Rate on the Ejector

- i** Do not overwind past the stop on the valve screw. The blow off flow rate can be adjusted within the range between 0% and 100%.

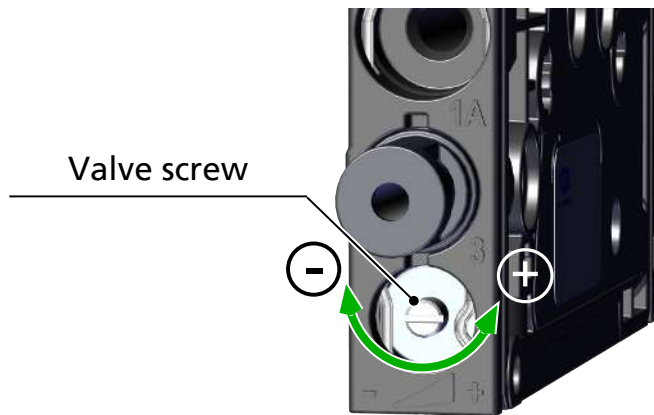

The figure shows the position of the valve screw, which can be used to adjust the blow off flow rate. The valve screw is equipped with a stop on both sides.

1. Turn the valve screw clockwise to reduce the flow rate.
2. Turn the valve screw counterclockwise to increase the flow rate.

12 Troubleshooting

12.1 Help with Faults

Fault	Possible cause	Solution
Power supply disrupted	Electrical connection	▶ Make sure device is properly connected to power
No communication	Incorrect electrical connection	▶ Check electrical connection and pin assignment
	Higher-level controller not correctly configured	▶ Check the controller configuration
	IODD connection does not work	▶ Check the IODD
No NFC communication	NFC connection between ejector and reader (e.g. smartphone) not correct	▶ Hold the reader at the intended position on the ejector
	NFC function on reader (e.g. smartphone) not activated	▶ Activate NFC function on reader
	NFC deactivated on ejector	▶ Activate NFC function on ejector
	Write operation canceled	▶ Hold the reader at the intended position on the ejector
No parameters can be changed using NFC	PIN code for NFC write protection activated	▶ Enable NFC write permissions
Ejector does not respond	No power supply	▶ Check electrical connection and pin assignment
	No compressed air supply	▶ Check the compressed air supply
Vacuum level is not reached or vacuum is built up too slowly	Silencer is dirty	▶ Replace the silencer
	Leakage in hose line	▶ Check hose connections
	Leakage at suction cup	▶ Check suction cup
	Operating pressure too low	▶ Increase operating pressure. Note the maximum limits!
	Internal diameter of hose line too small	▶ Observe recommendations for hose diameter
Load cannot be held	Vacuum level too low	▶ Increase the control range for the air saving function
	Suction cup too small	▶ Select a larger suction cup
No display on the screen	ECO mode activated	▶ Press any button or deactivate ECO mode
	Faulty electrical connection	▶ Check electrical connection and pin assignment
Display shows error code	See "Error codes" table	▶ See "Error Codes" table in the following chapter

Fault	Possible cause	Solution
Warning message/IO-Link warning message "Leakage too high" although handling cycle is working optimally	Limit value -L- (permissible leakage per second) set too low	▶ Determine typical leakage values in a good handling cycle and set as limit value
	Limit values SP1 and rP1 for leakage measurement set too low	▶ Set limit values in such a way that there is a clear differentiation between the neutral and suction system states.
Warning message/IO-Link warning message "Leakage too high" does not appear although there is high leakage in the system	Limit value -L- (permissible leakage per second) set too high	▶ Determine typical leakage values in a good handling cycle and set as limit value
	Limit values SP1 and rP1 for leakage measurement set too high.	▶ Set limit values in such a way that there is a clear differentiation between the neutral and suction system states.

12.2 Error Codes, Causes and Solutions

The condition monitoring functions output events that can be used to draw conclusions with regard to the process. If a known error occurs, it is transmitted via the IO-Link ISDU parameter [0x0082] in the form of an error number.

The system status is automatically refreshed on the NFC tag every 5 minutes at the latest. That means that an error may be displayed via NFC even though it has already disappeared.

Error code/ Display code	Fault	Possible cause	Solution
E01	Internal error Electronics	Operating voltage was disconnected too quickly after a parameter change, saving process was not complete	<ol style="list-style-type: none"> 1. Clear the error by restoring the factory setting with the [rES] function or parameter. 2. Use engineering tool to import a valid dataset. 3. If error [E01] occurs again after restarting the supply voltages: Replacement by Schmalz required
E03	Zero-point error/ calibration error on vacuum sensor	Zero-point adjustment for vacuum sensor is outside of the tolerance 3% FS. Calibration was canceled when measurement value was too high or too low.	<ol style="list-style-type: none"> 1. Ventilate the vacuum circuit. 2. Perform calibration.
E07	Undervoltage U_s	Sensor supply voltage is too low.	<ol style="list-style-type: none"> 1. Check power supply unit and power load 2. Increase supply voltage
E08	IO-Link error	Connection to master interrupted.	<ol style="list-style-type: none"> 1. Check connection line. 2. Repeat the power up process.
E17	Overvoltage U_s	Sensor supply voltage is too high.	<ol style="list-style-type: none"> 1. Check power supply unit. 2. Reduce supply voltage
FFF	Vacuum range	Measured vacuum level too high, sensor defective	<ol style="list-style-type: none"> 1. Check and adjust supply pressure.

Error code/ Display code	Fault	Possible cause	Solution
			2. Replacement by Schmalz re- quired
-FF	Overpressure in vacuum system	Ejector in "Blow-off" mode	No error! Overpressure display
E90	Manual mode	Manual mode locked by IO- Link.	▶ If necessary, use IO-Link to en- able manual mode.

12.3 System condition monitoring (CM)

The overall status of the ejector system is displayed as a status traffic light using 2 bits of process data input byte 0. All warnings and errors are taken into account when defining the status of the display.

This basic display provides immediate information about the status of the ejector.

The table below shows and explains the various status traffic light patterns:

Displayed system status	Description of operation modes
Green	System is working perfectly with optimal operating parameters
Yellow	Warning – Condition monitoring warnings in place; ejector system not functioning perfectly Check operating parameters
Orange	Warning – Serious condition monitoring warnings in place; ejector system not functioning perfectly Check operating parameters
rot	Error – Error code provided in parameter error; safe operation of the ejector within the operating limits is no longer ensured <ul style="list-style-type: none"> • Cease operation • Check the system

12.4 Warnings and Error Messages in IO-Link Mode

In IO-Link mode, status information is available in addition to the error messages displayed in SIO mode.

More details on this can be found in the final section of the enclosed Data Dictionary, "Coding of Extended Device Status (ISDU 138) and IO-Link Events".

Any condition monitoring events that occur during the suction cycle cause the system status light to immediately switch from green to yellow/orange. The specific event that caused this switch can be seen in the "Condition monitoring" IO-Link parameter.

13 Maintenance

13.1 Safety

Maintenance work may only be carried out by qualified personnel.



WARNING

Risk of injury due to incorrect maintenance or troubleshooting

- ▶ Check the proper functioning of the product, especially the safety features, after every maintenance or troubleshooting operation.



NOTE

Incorrect maintenance work

Damage to the ejector!

- ▶ Always switch off supply voltage before carrying out any maintenance work.
- ▶ Secure it so that it cannot be switched back on.
- ▶ The ejector must only be operated with a silencer.

- ▶ Before carrying out any work on the system, ensure that the ejector's compressed air circuit is vented to atmospheric pressure!

13.2 Cleaning the Ejector

1. For cleaning, do not use aggressive cleaning agents such as industrial alcohol, white spirit or thinners. Only use cleaning agents with pH 7–12.
2. Remove dirt on the exterior of the device with a soft cloth and soap suds at a maximum temperature of 60° C. Make sure that the silencer is not soaked in soapy water.
3. Ensure that no moisture can reach the electrical connection or other electrical components.

13.3 Replacing the Silencer

Heavy infiltration of dust, oil, etc. may contaminate the silencer and reduce the suction capacity. Cleaning the silencer is not recommended due to the capillary effect of the porous material.

If the suction capacity decreases, replace the silencer:

- ✓ Deactivate the ejector and depressurize the pneumatic systems.

1. Place a small flat screwdriver on the ejector as shown and loosen the clamp.

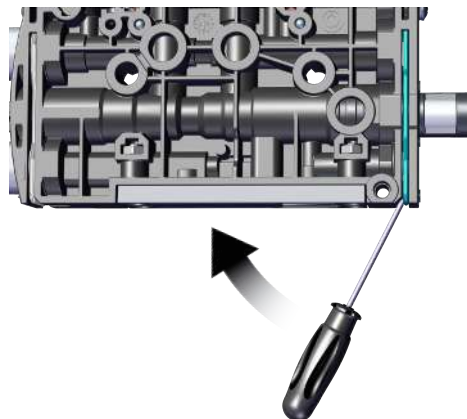

2. Remove the clamp.

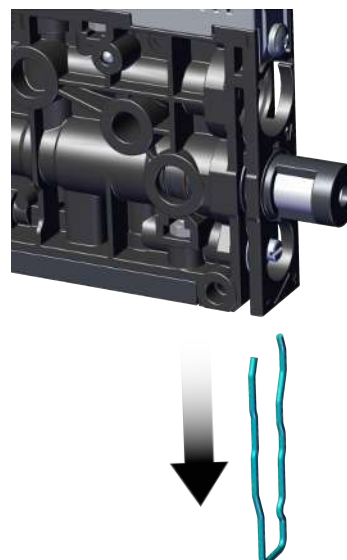

3. Then remove the silencer and filter from the ejector.

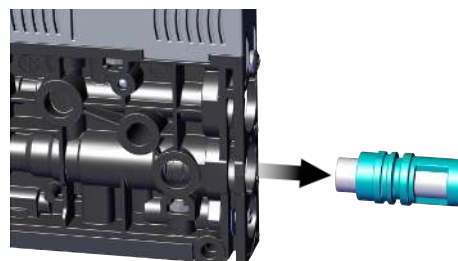

- 4. Pull the filter out of the housing and dispose of it.



- 5. Insert the new filter into the housing and re-install the silencer.



- 6. Mount the clamp in the correct position!

⇒ The clamp is mounted flush with the underside of the ejector and the clamp legs both lie in the grooves. It does not protrude from the ejector.

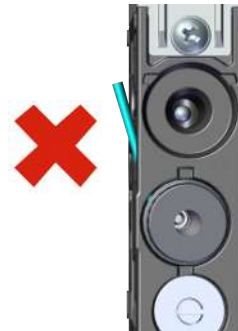

- 7. Check that the silencer is held tightly by pulling on the housing (hand-tight).

14 Warranty

This system is guaranteed in accordance with our general terms of trade and delivery. The same applies to spare parts, provided that these are original parts supplied by us.

We are not liable for any damage resulting from the use of non-original spare parts or accessories.

The exclusive use of original spare parts is a prerequisite for the proper functioning of the ejector and for the validity of the warranty.

Wearing parts are not covered by the warranty.

15 Spare and Wearing Parts, Accessories

15.1 Spare and Wearing Parts

Maintenance work may only be carried out by qualified personnel.



⚠ WARNING

Risk of injury due to incorrect maintenance or troubleshooting

- ▶ Check the proper functioning of the product, especially the safety features, after every maintenance or troubleshooting operation.

The following list contains the primary spare and wearing parts.

Designation	Part no.	Type
Silencer	10.02.02.05403	W
NO ejector suction valve for nozzle size 03	10.05.01.00394	S
NO ejector suction valve for nozzle size 05/07/10	10.05.01.00382	S
NC ejector suction valve for nozzle size 03	10.05.01.00382	S
NC ejector suction valve for nozzle size 05/07/10	10.05.01.00394	S
Blow-off valve (NC valve)	10.05.01.00382	S

Legend:	S ...	Spare part
	W ...	Wearing part

When tightening the fastening screws on the valves, observe the maximum tightening torque of 0.1 Nm.

15.2 Accessories

Designation	Part no.	Note
Connection cable, ASK WB-M8-6 2000 K-6P	21.04.05.00488	M8 socket, 6-pole; length: 2000 mm; open cable end, 6-pole; 90° angle
Connection cable, ASK B-M8-6 5000 K-6P	21.04.05.00255	M8 socket, 6-pole; length: 5000 mm; open cable end, 6-pole
Connection cable, ASK WB-M8-6 2000 S-M12-5	21.04.05.00489	M8 socket, 6-pole; cable length: 2000 mm; M12 plug, 5-pole; 90° angle
Plug-in screw union M5	10.08.02.00468	—
Plug-in screw union M7	10.08.02.00469	—
DIN rail mounting kit	10.02.02.05805	—
Mounting kit (mounting bracket)	10.02.02.05824	—

16 Decommissioning and Recycling

16.1 Disposing of the Ejector

1. Dispose of the product properly after replacement or decommissioning.
2. Observe the country-specific guidelines and legal obligations for waste prevention and disposal.

16.2 Materials Used

Component	Material
Housing	PA6-GF
Inner components	Aluminum alloy, anodized aluminum alloy, stainless steel, POM
Controller housing	PC/ABS
Silencer insert	Porous PE
Screws	Galvanized steel
Sealing	Nitrile rubber (NBR)
Lubrication	Silicone-free

17 Appendix

See also

📄 SCPMi Data Dictionary 21.10.01.00125_00.pdf [▶ 64]

17.1 Overview of Display Codes

Display code	Parameter	Note
SP 1	Switching point 1	Switch-off value for air-saving function/control
rP 1	Reset point 1	Reset value 1 for the control function
SP2	Switching point 2	Activation value of "Parts control" signal output
rP2	Reset point 2	Reset value 2 for the "Parts control" signal
tBL	Blow off time	Set the blow-off time for time-controlled blow-off
cAL	Zero-point adjustment	Calibrate the vacuum sensor
EF	Extended functions	Open the "Extended Functions" submenu
INF	Information	Open the "Information" submenu
cc 1	Total counter 1	Counter for suction cycles (suction signal input)
cc 2	Total counter 2	Counter for valve switching frequency
cc 3	Total counter 3	Counter for condition monitoring events
ct 1	Counter 1	Erasable counter for suction cycles ("Suction" signal input)
ct 2	Counter 2	Erasable counter for valve switching frequency
ct 3	Counter 3	Erasable counter for condition monitoring events
rc t	Erase counters	Erases counters ct1, ct2 and ct3
SoC	Software function	Displays the current software version
Snr	Serial number	Displays the serial number of the ejector
Art	Part number	Displays the part number of the ejector
un i	Vacuum unit	Vacuum unit in which the measurement and setting values are displayed
bAr	Vacuum level in mbar	The displayed vacuum is shown in mbar.
PS i	Vacuum level in psi	The displayed vacuum level is shown in psi.
- iH	Vacuum level in inHg	The displayed vacuum is shown in inches of Hg.
kPA	Vacuum level in kPa	The displayed vacuum level is shown in kPa.
t - 1	Max. permissible evacuation time	Set the maximum permitted evacuation time
-L -	Max. permissible leakage	Set the maximum permissible leakage in mbar/s
dLY	Switch-off delay	Set the switch-off delay for switching signals SP1 and SP2 (Ou2) (delay)
ECO	ECO mode	Dim/switch off the display
ct r	Control	Set the air saving function (control function)
on S	Control function on with leakage monitoring	Switches on the air saving function with leakage monitoring
dc S	Deactivate auto. control shutoff	Suppresses the automatic valve protection function when set to YES.

Display code	Parameter	Note
OU2	Output function	Set the switching logic for the output to NO or NC
P-n	Output type	Set the output level, PNP or NPN
blO	Blow-off function	Parameter for configuring the blow-off function
-E-	"External" blow-off	Selection of externally controlled blow-off
I-t	"Internally time-controlled" blow-off	Selection of internally controlled blow-off (triggered internally; time-adjustable)
E-t	"Externally time-controlled" blow-off	Selection of externally controlled blow-off (triggered externally; time-adjustable)
P In	PIN code	PIN code entry
Loc	Input locked	Parameter modification locked.
Unc	Input enabled	Parameter modification unlocked.
dPY	Display rotation	Setting the display position (rotation)
Std	Default display	Display is not rotated
rot	Rotated display	Display is rotated by 180°
rES	Reset	All values are reset to the factory settings.
nFC	NFC lock	ON --> Input and output enabled d IS --> Completely switched off LOC --> Write-protected
inc	Inconsistent	The entered value is not within the permissible value range. This is an informational message that appears if incorrect information is entered.
oor	Out of range	Input value invalid
dAt	Data access	Editing process in menu interrupted due to simultaneous parametrizing via IO-Link or NFC.

17.2 EC Declaration of Conformity

EC Declaration of Conformity

The manufacturer Schmalz confirms that the Ejector described in these operating instructions fulfill the following applicable EC directives:

2014/30/EU	Electromagnetic Compatibility
2011/65/EU	Directive on the restriction of the use of certain hazardous substances in electrical and electronic equipment

The following harmonized standards were applied:

EN 61000-6-4	Electromagnetic Compatibility - Emission
EN 61000-6-2	Electromagnetic Compatibility - Immunity
EN 61000-4-2	Electromagnetic Compatibility (EMC) – Part 4-2: Testing and measuring procedures

21.10.01.00125



J. Schmalz GmbH
Johannes-Schmalz-Str. 1, D 72293 Glatten
Tel.: +49(0)7443/2403-0
Fax: +49(0)7443/2403-259
info@schmalz.de



IO-Link Implementation		
Vendor ID		234 (0x00EA)
Device ID		100245 (0x018795)
SIO-Mode		Yes
IO-Link Revision		1.1 (compatible with 1.0)
IO-Link Bitrate		38.4 kBit/sec (COM2)
Minimum Cycle Time		3.4 ms
Process Data Input		4 bytes
Process Data Output		2 bytes

Process Data						
Process Data Input	Name	Bits	Data Type	Access	Special Values	Remark
PD In Byte 0	Signal SP2 (part present)	0	Boolean	ro		Vacuum is over SP2 & not yet under rP2
	Signal SP1 (air saving function)	1	Boolean	ro		Vacuum is over SP1 & not yet under rP1
	reserved	2	Boolean	ro		not used
	CM-Autoset acknowledged	3	Boolean	ro		Acknowledge that the Autoset function has been completed
	EPC-Select acknowledged	4	Boolean	ro		Acknowledge that EPC values 1 and 2 have been switched according to EPC-Select: 0 - EPC-Select = 00 1 - otherwise
	Signal SP3 (part detached)	5	Boolean	ro		The part has been detached after a suction cycle
PD In Byte 1	Device status	7 ... 6	2 bit integer	ro		00 - [green] Device is working optimally 01 - [yellow] Device is working but there are warnings 10 - [orange] Device is working but there are severe warnings 11 - [red] Device is not working properly
		7..0	8 bit integer	ro		EPC value 1 (byte) Holds 8bit value as selected by EPC-Select 0/1 00 - Input pressure (0.1 bar) 01 - CM-Warnings (ISDU 146, bits 0-7) 10 - Leakage of last suction cycle (mbar/sec) 11 - Primary supply voltage (Vot)
PD In Byte 2	EPC value 2, high-byte	7..0	16 bit integer	ro		EPC value 2 (word) Holds 16bit value as selected by EPC-Select 0/1 00 - System vacuum (mbar) 01 - Evacuation time t1 (msec) 10 - Last measured free-flow vacuum (mbar) 11 - Air consumption of last suction cycle (0.1 NL)
PD In Byte 3	EPC value 2, low-byte	7..0				
Process Data Out	Name	Bit	Access	Availability	Special Values	Remark
PD Out Byte 0	Vacuum	0	Boolean	wo		Vacuum on/off
	Blow-off	1	Boolean	wo		Activate Blow-off
	Setting Mode	2	Boolean	wo		Vacuum on/off with continuous suction disabled (regardless of dCS parameter)
	CM Autoset	3	Boolean	wo		Perform CM Autoset function (teach permissible leakage and permissible evacuation time)
	EPC-Select 0	4	Boolean	wo		Select the function of EPC values 1 and 2 (2-bit binary coded) (see PD In Byte 1...3)
	EPC-Select 1	5	Boolean	wo		
	Profile-Set 0	6	Boolean	wo		Select Production Profile (2-bit binary coded) (see ISDU parameter areas P0 to P3)
PD Out Byte 1	Input Pressure	7..0	8 bit integer	wo		Pressure value from external sensor (unit: 0.1 bar)

ISDU Parameters									
ISDU Index	Subindex	Display Appearance	Parameter	Size	Value Range	Access	Default Value / Example	Remark	
dec	hex	dec							
Identification									
Device Management									
16	0x0010	0	Vendor Name	1...32 bytes		ro	J. Schmalz GmbH	Manufacturer designation	
17	0x0011	0	Vendor Text	1...32 bytes		ro	www.schmalz.com	Internet address	
18	0x0012	0	Product Name	1...32 bytes		ro	SCPMi	General product name	
19	0x0013	0	Product ID	1...32 bytes		ro	SCPMi	Product variant name	
20	0x0014	0	Product Text	1...32 bytes		ro	SCPMi 05 S01 NC M8-6	Order-code	
21	0x0015	0	Snr	Serial Number	9 bytes	ro	00000001	Serial number	
22	0x0016	0	Hardware Revision	2 bytes		ro	03	Hardware revision	
23	0x0017	0	SoC	Firmware Revision	4 bytes	ro	0.0D	Firmware revision	
240	0x00F0	0	Unique ID	20 bytes		ro		Unique device identification number	
241	0x00F1	0	Device Features	11 bytes		ro		Type code of device features (see IODD)	
250	0x00FA	0	Art	Article Number	14 bytes	ro	10.02.02.*	Order-number	
251	0x00FB	0	Article Revision	2 bytes		ro	00	Article revision	
252	0x00FC	0	Production Date	3 bytes		ro	C19	Date code of production (month+year, month is letter coded, e.g. F18 = July 2018)	
254	0x00FE	0	Detailed Product Text	1...64 bytes		ro	SCPMi 05 S01 NC M8-6	Detailed type description of the device	
Device Localization									
24	0x0018	0	Application Specific Tag	1...32 bytes		rw	***	User string to store location or tooling information	
242	0x00F2	0	Equipment Identification	1...64 bytes		rw	***	User string to store identification name from schematic	
246	0x00F6	0	Geolocation	1...64 bytes		rw	***	User string to store geolocation from handheld device	
247	0x00F7	0	IODD Web Link	1...64 bytes		rw	***	User string to store web link to IODD file	
248	0x00F8	0	NFC Web Link	1...64 bytes	http://... https://...	rw	https://myproduct.schmalz.com/#/	Web link to NFC app (base URL for NFC tag)	
249	0x00F9	0	Storage Location	1...32 bytes		rw	***	User string to store storage location	
253	0x00FD	0	Installation Date	1...16 bytes		rw	***	User string to store date of installation	
Parameter									
Device Settings									
Commands									
2	0x0002	0	System Command	1 byte	5, 130, 165, 167, 168, 169	wo		0x05 (dec 5): Force upload of parameter data into the master 0x82 (dec 130): Restore device parameters to factory defaults 0xA5 (dec 165): Calibrate vacuum sensor 0xA7 (dec 167): Reset erasable counters ct1, ct2, ct3 0xA8 (dec 168): Reset voltages HI/LO 0xA9 (dec 169): Reset vacuum/pressure HI/LO	
Access Control									
12	0x000C	0	Device Access Locks	2 bytes	0, 4	rw	0	Bit 0-1: reserved Bit 2: Local parameterization lock (lock menu editing) Bit 3-15: reserved	
90	0x005A	0	nFc	Extended Device Access Locks	1 byte	rw	0	Bit 0: NFC write lock Bit 1: NFC disable Bit 2: Not used Bit 3: local user interface locked (manual mode locked) Bit 4: IO-Link event lock (suppress sending IO-Link events) Bit 5-7: Not used	
77	0x004D	0	Pin	Menu PIN code	2 bytes	rw	0	0 = Menu editing unlocked >0 = Menu editing locked with pin-code	
91	0x005B	0	NFC PIN code	NFC PIN code	2 bytes	rw	0	PIN for writing data from NFC app	



J. Schmalz GmbH
 Johannes-Schmalz-Str. 1, D 72293 Glatten
 Tel.: +49(0)7443/2403-0
 Fax: +49(0)7443/2403-259
 info@schmalz.de



Initial Settings									
69	0x0045	0	bl_o	Blow-off mode	1 byte	0 - 2	rw	0	0 = Externally controlled blow-off (-E-) 1 = Internally controlled blow-off - time-dependent (-t-) 2 = Externally controlled blow-off - time-dependent (-E-)
71	0x0047	0	Ou2	Output 2 function	1 byte	0 - 1	rw	0	0 = NO 1 = NC
73	0x0049	0	P-n	Signal Type	1 byte	0 - 1	rw	0	0 = PNP 1 = NPN
74	0x004A	0	uni	Display Unit	1 byte	0 - 3	rw	0	0 = mbar 1 = kPa 2 = inHg 3 = psi
75	0x004B	0	dL_Y	Output filter	2 byte	0 - 999	rw	10	Unit: 1 ms
76	0x004C	0	Eco	Eco-Mode	1 byte	0 - 2	rw	0	0 = off 1 = on (full eco mode with display switching off completely) 2 = Lo (medium eco mode with display dimmed to 50%)
79	0x004F	0	diS	Display Rotation	1 byte	0 - 1	rw	0	0 = Standard 1 = Rotated
Process Settings									
275	0x0113		P-n	Number of active profile	1 byte		ro		Number of the active profile: 0 - 3
Production Setup - Profile P0									
68	0x0044	0	Clr	Air saving function	1 byte	0 - 2	rw	1	0 = not active (off) 1 = active (on) 2 = active with supervision (onS)
78	0x004E	0	dCS	Disable continuous suction	1 byte	0 - 1	rw	0	0 = off 1 = on
100	0x0064	0	SP1	Switch Point 1	2 bytes	999 > SP1 > rP1	rw	750	Unit: 1 mbar
101	0x0065	0	rP1	Reset Point 1	2 bytes	SP1 > rP1 > SP2	rw	600	Unit: 1 mbar
102	0x0066	0	SP2	Switch Point 2	2 bytes	rP1 > SP2 > rP2	rw	550	Unit: 1 mbar
103	0x0067	0	rP2	Reset Point 2	2 bytes	SP2 > rP2 >= 10	rw	540	Unit: 1 mbar
106	0x006A	0	tbl	Duration automatic blow	2 bytes	10 - 9999	rw	200	Unit: 1 ms
107	0x006B	0	t-1	Permissible evacuation time	2 bytes	0 - 9999	rw	2000	Unit: 1 ms. No t-1 Warning if set to 0
108	0x006C	0	L-	Permissible leakage rate	2 bytes	0 - 999	rw	250	Unit: 1 mbar/sec. No L- Warning if set to 0
119	0x0077	0		Profile name	1...32 bytes		rw	***	
Production Setup - Profile P1									
180	0x00B4	0		Air saving function	1 byte	0 - 2	rw	1	Profile P-1 (selected by PD Out 0 - Profile-Set = 1)
181	0x00B5	0		Disable continuous suction	1 byte	0 - 1	rw	0	
182	0x00B6	0		Switch Point 1	2 bytes	999 > SP1 > rP1	rw	750	
183	0x00B7	0		Reset Point 1	2 bytes	SP1 > rP1 > SP2	rw	600	
184	0x00B8	0		Switch Point 2	2 bytes	rP1 > SP2 > rP2	rw	550	
185	0x00B9	0		Reset Point 2	2 bytes	SP2 > rP2 >= 10	rw	540	
186	0x00BA	0		Duration automatic blow	2 bytes	10 - 9999	rw	200	
187	0x00BB	0		Permissible evacuation time	2 bytes	0 - 9999	rw	2000	
188	0x00BC	0		Permissible leakage rate	2 bytes	0 - 999	rw	250	
199	0x00C7	0		Profile name	1...32 bytes		rw	***	
Production Setup - Profile P2									
200	0x00C8	0		Air saving function	1 byte	0 - 2	rw	1	Profile P-2 (selected by PD Out 0 - Profile-Set = 2)
201	0x00C9	0		Disable continuous suction	1 byte	0 - 1	rw	0	
202	0x00CA	0		Switch Point 1	2 bytes	999 > SP1 > rP1	rw	750	
203	0x00CB	0		Reset Point 1	2 bytes	SP1 > rP1 > SP2	rw	600	
204	0x00CC	0		Switch Point 2	2 bytes	rP1 > SP2 > rP2	rw	550	
205	0x00CD	0		Reset Point 2	2 bytes	SP2 > rP2 >= 10	rw	540	
206	0x00CE	0		Duration automatic blow	2 bytes	10 - 9999	rw	200	
207	0x00CF	0		Permissible evacuation time	2 bytes	0 - 9999	rw	2000	
208	0x00D0	0		Permissible leakage rate	2 bytes	0 - 999	rw	250	
219	0x00DB	0		Profile name	1...32 bytes		rw	***	
Production Setup - Profile P3									
220	0x00DC	0		Air saving function	1 byte	0 - 2	rw	1	Profile P-3 (selected by PD Out 0 - Profile-Set = 3)
221	0x00DD	0		Disable continuous suction	1 byte	0 - 1	rw	0	
222	0x00DE	0		Switch Point 1	2 bytes	999 > SP1 > rP1	rw	750	
223	0x00DF	0		Reset Point 1	2 bytes	SP1 > rP1 > SP2	rw	600	
224	0x00E0	0		Switch Point 2	2 bytes	rP1 > SP2 > rP2	rw	550	
225	0x00E1	0		Reset Point 2	2 bytes	SP2 > rP2 >= 10	rw	540	
226	0x00E2	0		Duration automatic blow	2 bytes	10 - 9999	rw	200	
227	0x00E3	0		Permissible evacuation time	2 bytes	0 - 9999	rw	2000	
228	0x00E4	0		Permissible leakage rate	2 bytes	0 - 999	rw	250	
239	0x00EF	0		Profile name	1...32 bytes		rw	***	
Observation									
Monitoring									
Process Data									
40	0x0028	0		Process Data In Copy	4 bytes		ro		Copy of currently active process data input
41	0x0029	0		Process Data Out Copy	2 bytes		ro		Copy of currently active process data output
64	0x0040	1		Vacuum Value	2 bytes		ro		Actual vacuum value
64	0x0040	2		Vacuum Value LO	2 bytes		ro		Lowest measured vacuum value since power-up
64	0x0040	3		Vacuum Value HI	2 bytes		ro		Highest measured vacuum value since power-up
65	0x0041	1		Pressure Value	2 bytes		ro		Actual pressure value (unit: 1 mbar)
65	0x0041	2		Pressure Value LO	2 bytes		ro		Lowest measured pressure value since power-up
65	0x0041	3		Pressure Value HI	2 bytes		ro		Highest measured pressure value since power-up
66	0x0042	1		Supply Voltage	2 bytes		ro		Supply voltage (unit: 0.1 Volt)
66	0x0042	2		Supply Voltage LO	2 bytes		ro		Lowest measured supply voltage since power-up
66	0x0042	3		Supply Voltage HI	2 bytes		ro		Highest measured supply voltage since power-up
148	0x0094	0		Evacuation time t ₀	2 bytes		ro		Time from start of suction to SP2 (unit: 1 ms)
149	0x0095	0		Evacuation time t ₁	2 bytes		ro		Time from SP2 to SP1 (unit: 1 ms)
160	0x00A0	0		Leakage rate	2 bytes		ro		Leakage of last suction cycle (unit: 1 mbar/sec)
161	0x00A1	0		Free-flow vacuum	2 bytes		ro		Last measured free-flow vacuum (unit: 1 mbar)
164	0x00A4	0		Max. reached vacuum in last cycle	2 bytes		ro		Maximum vacuum value of last suction cycle
165	0x00A5	0		Min. pressure during last cycle	2 bytes		ro		Minimum input pressure during suction phase of last cycle
Communication Mode									
564	0x0234	0		Communication Mode	1 byte		ro		0x00 = SiO mode 0x10 = IO-Link revision 1.0 (set by master) 0x11 = IO-Link revision 1.1 (set by master)
Counters									
140	0x008C	0	cc1	Vacuum-on counter	4 bytes		ro		Not erasable (stored every 1000 counts)
141	0x008D	0	cc2	Valve operating counter	4 bytes		ro		Not erasable (stored every 1000 counts)
142	0x008E	0	cc3	Condition monitoring counter	4 bytes		ro		Not erasable (stored every 1000 counts)
143	0x008F	0	ct1	Erasable vacuum-on counter	4 bytes		ro		Can be reset by System Command "Reset erasable counters" (stored every 1000 counts)
144	0x0090	0	ct2	Erasable valve operating counter	4 bytes		ro		Can be reset by System Command "Reset erasable counters" (stored every 1000 counts)
145	0x0091	0	ct3	Erasable condition monitoring counter	4 bytes		ro		Can be reset by System Command "Reset erasable counters" (stored every 1000 counts)



J. Schmalz GmbH
 Johannes-Schmalz-Str. 1, D 72293 Glatten
 Tel.: +49(0)7443/2403-0
 Fax: +49(0)7443/2403-259
 info@schmalz.de



Diagnosis									
Device Status									
32	0x0020	0		Error Count	2 bytes		ro		Number of errors since last power-up
36	0x0024	0		IO-Link Device Status	1 byte		ro		0 = Device is operating properly 1 = Maintenance required 2 = Out of specification 3 = Functional check 4 = Failure
37	0x0025	0		Detailed Device Status	96 bytes		ro		Information about currently pending events Fixed-length array format according to IO-Link specification V1.1
130	0x0082	0		Active Errors	2 bytes		ro		Bit 00: Internal error: data corruption (E01) Bit 01: reserved Bit 02: Primary voltage too low (E07) Bit 03: Primary voltage too high (E17) Bit 04-07: reserved Bit 08: short circuit at OUT2 (E12) Bit 09-10: reserved Bit 11: Measurement range overrun (FFF) Bit 12-14: reserved Bit 15: IO-Link communication interruption (E08)
138	0x008A	1		Extended Device Status - Type	1 byte		ro		Type code of active device status (see below)
138	0x008A	2		Extended Device Status - ID	2 bytes		ro		ID code of active device status (see below, corresponds to IO-Link events)
139	0x008B	0		NFC Status	1 byte		ro		Result of recent NFC activity: 0x00: Data valid, write finished successfully 0x23: Write failed: Write access locked 0x30: Write failed: parameter(s) out of range 0x31: Write failed: parameter value too high 0x32: Write failed: parameter value too low 0x41: Write failed: parameter set inconsistent 0x41: Write failed: invalid authorisation 0xA2: NFC not available 0xA3: Write failed: invalid data structure 0xA5: Write pending 0xA6: NFC internal error
Condition Monitoring [CM]									
146	0x0092	0		Condition monitoring	2 bytes		ro		Bit 0: Valve protection active Bit 1: Evacuation time t1 above limit [-t-1] Bit 2: Leakage rate above limit [-L-] Bit 3: SP1 not reached in suction cycle Bit 4: Free-flow vacuum > rP2 but < SP1 Bit 5: Primary voltage US outside of optimal range Bit 6: reserved Bit 7: reserved Bit 8: Input pressure outside of operating range Bit 9-15: reserved
Energy Monitoring [EM]									
155	0x009B	0		Air consumption per cycle in percent	1 byte		ro		Air consumption of last suction cycle (unit: 1 %)
156	0x009C	0		Air consumption per cycle	2 bytes		ro		Air consumption of last suction cycle (unit: 0.1 NI)
157	0x009D	0		Energy consumption per cycle	2 bytes		ro		Energy consumption of last suction cycle (unit: 1 Ws)
Predictive Maintenance [PM]									
162	0x00A2	0		Quality	1 byte		ro		Quality of last suction cycle (unit: 1 %)
163	0x00A3	0		Performance	1 byte		ro		Last measured performance level (unit: 1 %)

Coding of Extended Device Status (ISDU 138) and IO-Link Events

Extended Device Status ID (= IO-Link Event Code)		Extended Device Status Type		IO-Link Event Type	Display Code	Event name	Remark
dec	hex	hex	Meaning				
0	0x0000	0x10	Everything OK	(no IOL event)		Everything OK	Device is working optimally
6161	0x1811	0x82	Defect/fault, high	Error	E01	Data Corruption	Internal error, user data corrupted
35872	0x8C20	0x81	Defect/fault, lower	Error	FFF	Measurement range overrun	Measured vacuum value too high, sensor fault
2457	0x0999	0x81	Defect/fault, lower	(no IOL event)	E08	IO-Link communication interruption	IO-Link communication is interrupted (readable via NFC)
20736	0x5100	0x42	Critical condition, high	Error	E07	General power supply fault	Primary supply voltage (US) too low
20752	0x5110	0x42	Critical condition, high	Warning	E17	Primary supply voltage over-run	Primary supply voltage (US) too high
6146	0x1802	0x42	Critical condition, high	Warning		Supply pressure fault	Input pressure too high or too low
6156	0x180C	0x22	Warning, high	Warning		Primary supply voltage out of optimal range	Condition Monitoring: primary supply voltage US outside of operating range
6151	0x1807	0x22	Warning, high	Warning		CM: Valve protection active	Condition Monitoring: valve has switched too fast, continuous suction activated
6152	0x1808	0x21	Warning, low	Warning		CM: evacuation time above limit	Condition Monitoring: evacuation time t1 is above limit [-t-1]
6153	0x1809	0x21	Warning, low	Warning		CM: leakage rate above limit	Condition Monitoring: leakage rate is above limit [-L-]
6154	0x180A	0x22	Warning, high	Warning		CM: SP1 not reached	Condition Monitoring: vacuum level SP1 was never reached during suction cycle
6155	0x180B	0x21	Warning, low	Warning		CM: free flow vacuum too high	Condition Monitoring: free flow vacuum above SP2
35841	0x8C01	0x21	Warning, low	Warning		Simulation active	Manual mode is active
6144	0x1800	-	(IOL event only)	Notification		Vacuum calibration OK	Calibration offset 0 set successfully
6145	0x1801	0x22	Warning, high	Notification	E03	Vacuum calibration failed	Sensor value too high or too low, offset not changed
6167	0x1817	-	(IOL event only)	Notification		Autoset completed successfully	Permissible leakage and permissible evacuation time have been set automatically for the active profile
6168	0x1818	-	(IOL event only)	Notification		Handling Cycle Completed	Handling of the part is complete (neutral state of vacuum system reached or new suction phase begun)
30480	0x7710	0x41	Critical condition, low	Error	E12	short circuit at OUT2	output is connect with counterpotential

At your side worldwide

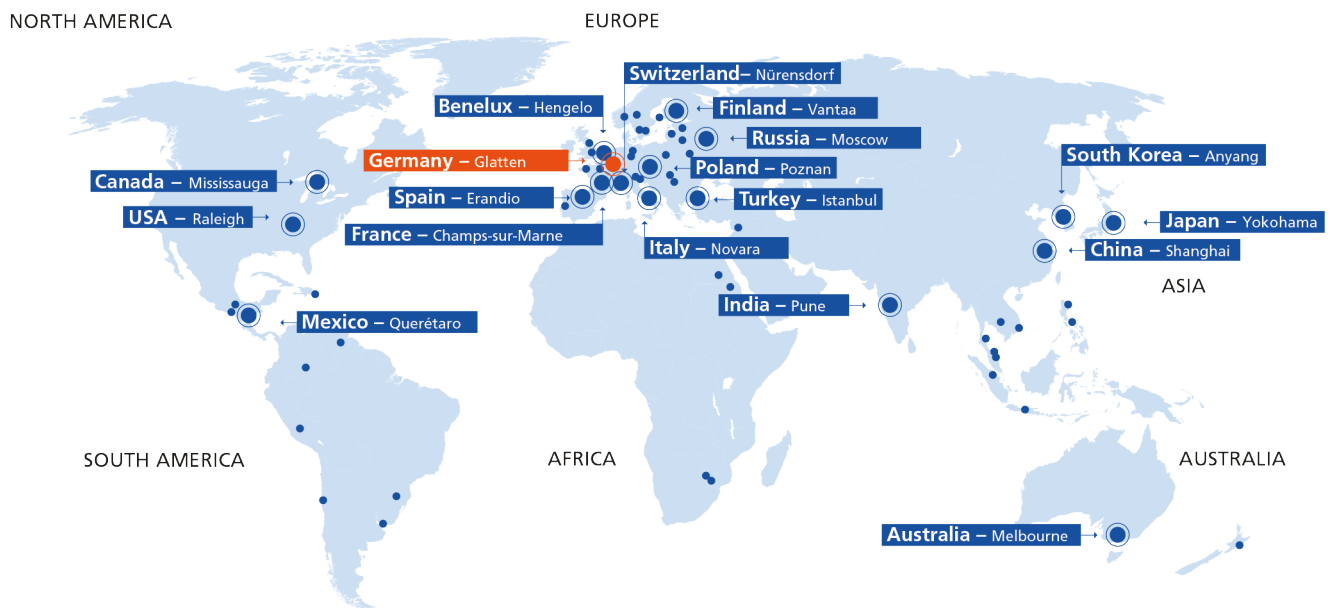

Headquarters

Schmalz Germany – Glatten

Sales Partners

You can find the Schmalz sales partner in your country at:
WWW.SCHMALZ.COM/SALESNETWORK

Subsidiaries

- Schmalz Australia – Melbourne
- Schmalz Benelux – Hengelo (NL)
- Schmalz Canada – Mississauga
- Schmalz China – Shanghai
- Schmalz Finland – Vantaa
- Schmalz France – Champs-sur-Marne
- Schmalz India – Pune
- Schmalz Italy – Novara
- Schmalz Japan – Yokohama

- Schmalz Mexico – Querétaro
- Schmalz Poland – Suchy Las (Poznan)
- Schmalz Russia – Moscow
- Schmalz South Korea – Anyang
- Schmalz Spain – Erandio (Vizcaya)
- Schmalz Switzerland – Nürens Dorf
- Schmalz Turkey – Istanbul
- Schmalz USA – Raleigh (NC)

Vacuum Automation

WWW.SCHMALZ.COM/AUTOMATION

Handling Systems

WWW.SCHMALZ.COM/HANDLINGSYSTEMS

J. Schmalz GmbH
 Johannes-Schmalz-Str. 1
 72293 Glatten, Germany
 T: +49 7443 2403-0
 schmalz@schmalz.de
 WWW.SCHMALZ.COM