



Compact Ejector SCPM_c

Operating Instructions

Note

The operating instructions were originally written in German. Store in a safe place for future reference. Subject to technical changes without notice. No responsibility is taken for printing or other types of errors.

Published by

© J. Schmalz GmbH, 05/19

This document is protected by copyright. J. Schmalz GmbH retains the rights established thereby. Reproduction of the contents, in full or in part, is only permitted within the limits of the legal provisions of copyright law. Any modifications to or abridgments of the document are prohibited without explicit written agreement from J. Schmalz GmbH.

Contact

J. Schmalz GmbH
Johannes-Schmalz-Str. 1
72293 Glatten, Germany
T: +49 7443 2403-0
schmalz@schmalz.de
www.schmalz.com

Contact information for Schmalz companies and trade partners worldwide can be found at:
www.schmalz.com/salesnetwork

Contents

1	Important information	6
1.1	Note on Using this Document	6
1.2	The technical documentation is part of the product	6
1.3	Warnings in this document	6
1.4	Symbol	6
1.5	Type Plate	7
2	Fundamental Safety Instructions	8
2.1	Emissions	8
2.2	Intended Use	8
2.3	Non-Intended Use	8
2.4	Personnel Qualification	9
2.5	Modifications to the Ejector	9
3	Product description	10
3.1	Description of the Ejector	10
3.1.1	Suction of the Workpiece (Vacuum Generation)	10
3.1.2	Depositing the Workpiece/Part (Blowing Off)	11
3.2	Operating Modes	11
3.3	Ejector Designation	11
3.4	Ejector Structure	12
3.5	Controls and Displays in Detail	13
4	Technical Data	15
4.1	Display Parameters	15
4.2	General Parameters	15
4.3	Electrical Parameters	15
4.4	Mechanical Data	16
4.4.1	Performance Data	16
4.4.2	Dimensions	16
4.4.3	Maximum Torque	17
4.4.4	Pneumatic circuit plans	17
4.4.5	Factory Settings	18
5	Operating and Menu Concepts	19
5.1	Button Assignments in Display Mode	19
5.1.1	Opening the Menu	19
5.1.2	Displaying the basic settings (slide show)	20
5.2	Main Menu	20
5.2.1	Functions in the Main Menu	20
5.2.2	Changing the Parameters of the Main menu	20
5.3	Extended Functions menu (EF)	21
5.3.1	Functions in the Extended Functions menu (EF)	21
5.3.2	Changing parameters in the Extended Functions menu	21
5.4	Info menu [INF]	22
5.4.1	Functions in the Info menu	22
5.4.2	How data is displayed in the info menu	23
6	Description of Functions	24
6.1	Overview of Functions	24

6.2	Operating Modes	24
6.2.1	Automatic Mode.....	24
6.2.2	Manual Mode	24
6.3	Monitoring the system vacuum and defining limit values	26
6.4	Calibrating the sensor	26
6.5	Control functions.....	26
6.5.1	No Control (Continuous Suction).....	27
6.5.2	Control	27
6.6	Blow off modes	27
6.6.1	Externally Controlled Blow-Off	27
6.6.2	Internally Time-Controlled Blow-Off.....	27
6.6.3	Setting the blow off time	27
6.7	Selecting the display unit.....	27
6.8	Reset to factory settings	28
6.9	Counters.....	28
6.10	Displaying the software version	29
6.11	Displaying the part number.....	29
6.12	Displaying the serial number.....	30
6.13	Condition Monitoring (CM)	31
6.13.1	Evacuation Time Monitoring	31
6.13.2	Leakage monitoring	32
7	Transport and storage	33
7.1	Checking the Delivery	33
8	Installation.....	34
8.1	Installation Instructions.....	34
8.2	Installation	34
8.3	Pneumatic Connection	35
8.3.1	Connecting the Compressed Air and Vacuum	36
8.3.2	Instructions for the Pneumatic Connection	36
8.3.3	Optional: External blow-off connection (EB).....	37
8.4	Electrical Connection.....	37
8.4.1	Pin assignments	38
9	Operation	40
9.1	General Preparations	40
9.2	Changing the Blow-Off Flow Rate on the Ejector.....	40
10	Troubleshooting.....	41
10.1	Help with Malfunctions	41
10.2	Error messages.....	42
11	Maintenance.....	43
11.1	Safety	43
11.2	Cleaning the Ejector	43
11.3	Replacing the Silencer.....	44
12	Warranty.....	46
13	Spare and Wearing Parts, Accessories.....	47
13.1	Spare and Wearing Parts	47
13.2	Accessories	47

14 Decommissioning and recycling	48
14.1 Disposing of the Ejector	48
14.2 Materials Used	48
15 Appendix	49
15.1 Overview of Display Codes	49
15.2 EC declaration of conformity.....	50

1 Important information

1.1 Note on Using this Document

J. Schmalz GmbH is generally referred to as Schmalz in this operating instructions.

These operating instructions contain important notes and information about the different operating phases of the product:

- Transport, storage, start of operations and decommissioning
- Safe operation, required maintenance, rectification of any faults

The operating instructions describe the product at the time of delivery by Schmalz.

1.2 The technical documentation is part of the product

1. For problem-free and safe operation, follow the instructions in the documents.
2. Keep the technical documentation in close proximity to the product. The documentation must be accessible to personnel at all times.
3. Pass on the technical documentation to subsequent users.
 - ⇒ Failure to follow the instructions in this operating instructions may result in life-threatening injuries!
 - ⇒ Schmalz is not liable for damage or malfunctions that result from failure to heed these instructions.

If you still have questions after reading the technical documentation, contact Schmalz-service at:

www.schmalz.com/services

1.3 Warnings in this document

Warnings warn against hazards that may occur when handling the product. This document contains three levels of danger that you can recognize by the signal word.

Signal word	Meaning
WARNING	Indicates a medium-risk hazard which, if not avoided, could result in death or serious injury.
CAUTION	Indicates a low-risk hazard which, if not avoided, could result in minor or moderate injury.
NOTE	Indicates a danger that leads to property damage.

1.4 Symbol



This sign indicates useful and important information.

- ✓ This symbol represents a prerequisite that must be met before an action is performed.
- ▶ This sign represents an action to be performed.
- ⇒ This sign represents the result of an action.

Actions that consist of more than one step are numbered:

1. First action to be performed.
2. Second action to be performed.

1.5 Type Plate



The type plate (1) is permanently attached to the ejector and must always be clearly legible.

The type plate contains the following data:

- Name, including individual configuration code "AAA"
- Part number
- Serial number
- Pneumatic symbol
- Permitted pressure range

Please specify all the information above when ordering replacement parts, making warranty claims or for any other inquiries.

2 Fundamental Safety Instructions

2.1 Emissions

The ejector emits noise due to its use of compressed air.



⚠ WARNING

Noise pollution due to the escape of compressed air

Hearing damage!

- ▶ Wear ear protectors.
 - ▶ The ejector must only be operated with a silencer.
-

2.2 Intended Use

The ejector is built in accordance with the latest standards of technology and is safe to operate upon delivery; however, hazards can still arise during use.

The ejector is designed to generate a vacuum for gripping and transporting objects when used in conjunction with suction cups. It is operated by a controller via discrete signals.

Neutral gases are approved as evacuation media. Neutral gases include air, nitrogen and inert gases (e.g. argon, xenon and neon).

The product is intended for industrial use.

Intended use includes observing the technical data and the installation and operating instructions in this manual.

2.3 Non-Intended Use



⚠ WARNING

Extraction of hazardous media, liquids or bulk material

Personal injury or damage to property!

- ▶ Do not extract harmful media such as dust, oil mists, vapors, aerosols etc.
 - ▶ Do not extract aggressive gases or media such as acids, acid fumes, bases, biocides, disinfectants or detergents.
 - ▶ Do not extract liquids or bulk materials, e.g. granulates.
-

Schmalz accepts no liability for damages caused by non-intended usage of the ejector. In particular, the following are considered non-intended use:

- Use in potentially explosive atmospheres
- Use in medical applications
- Lifting people or animals
- Evacuation of objects that are in danger of imploding

2.4 Personnel Qualification

Unqualified personnel cannot recognize dangers and are therefore exposed to higher risks!

1. Task only qualified personnel to perform the tasks described in this operating instructions.
2. The product must be operated only by persons who have undergone appropriate training.

This operating instructions is intended for fitters who are trained in handling the product and who can operate and install it.

2.5 Modifications to the Ejector

Schmalz assumes no liability for consequences of modifications over which it has no control:

1. The ejector must be operated only in its original condition as delivered.
2. Use only original spare parts from Schmalz.
3. The ejector must be operated only in perfect condition.

3 Product description

3.1 Description of the Ejector

3.1.1 Suction of the Workpiece (Vacuum Generation)

The ejector is designed for vacuum handling of airtight parts in combination with suction systems. The vacuum is generated in a nozzle according to the Venturi principle, i.e. by using suction generated by the flow of accelerated compressed air. Compressed air is channeled into the ejector and flows through the nozzle. A vacuum is generated immediately downstream of the motive nozzle; this causes the air to be sucked through the vacuum connection. The air and compressed air that have been removed by the suction exit together via the silencer.

The venturi nozzle on the ejector is activated and deactivated using the suction command:

- In the NO (normally open) variant, the venturi nozzle is deactivated when the suction signal is received.
- In the NC (normally closed) variant, the venturi nozzle is activated when the suction signal is received.

An integrated sensor records the vacuum generated by the venturi nozzle. The exact vacuum value is shown on the display.

The diagram below shows the vacuum curve for when the air saving function is activated:

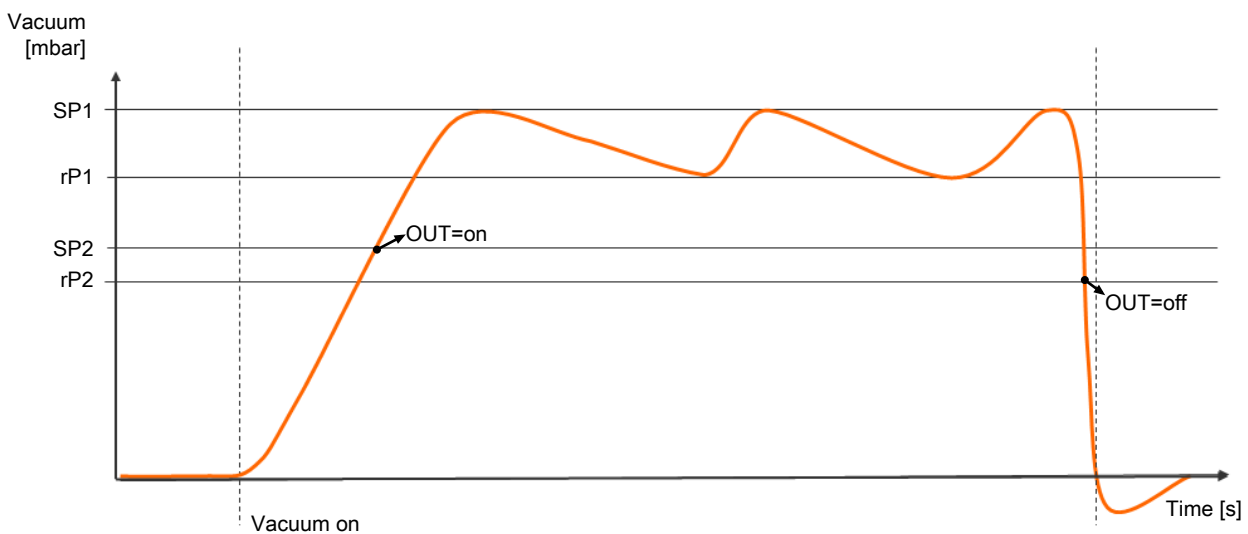

The ejector has an integrated air saving function and automatically regulates the vacuum in suction mode:

- The electronics switch the venturi nozzle off as soon as the vacuum limit value set for switching point SP1 is reached.
- When objects with airtight surfaces are picked up, the integrated non-return valve prevents the vacuum from dropping.
- If leaks cause the system vacuum to drop below the limit value configured for the rP1 switching point, the venturi nozzle is switched back on.
- The OUT output is set once a workpiece is picked up securely, based on the vacuum value. This enables the further handling process.

3.1.2 Depositing the Workpiece/Part (Blowing Off)

In blow off mode, the vacuum circuit of the ejector is supplied with compressed air. This ensures that the vacuum drops quickly, depositing the workpiece quickly as well.

During blow off, [-FF] is shown on the display.

The ejector provides two blow off modes for selection:

- Externally controlled blow off
- Internally time-controlled blow off
- Optional: external blow off

3.2 Operating Modes

If the ejector is connected to the supply voltage, it is ready for operation. This is the normal operating mode, in which the ejector is operated by the system controller.

The ejector is parameterized using the provided menus.

“Manual operation” mode can be selected during the setup process.

3.3 Ejector Designation

The breakdown of the item designation (e.g. SCPMc 10 S04 NC M8-6 PNP BLT) is as follows:

Feature	Variants	
Type	SCPM	
Version	Basic: b Controlled: c Intelligent: i	
Nozzle size	0.3, 0.5, 0.7 and 1.0 mm and EV for External Vacuum	
Fluid connector	S01 (push-in, 4/2 2x)	G01 (M5 female 2x)
	S04 (push-in, 6/4 2x)	G06 (M7 female 2x)
	S07 (push-in, 4/2 3x)	G07 (M5 female 3x)
	S08 (push-in, 6/4 2x, 4/2)	G08 (M7 female 2x, M5 female)
	S09 (push-in, 4/2, 6/4 2x)	G09 (M5 female, M7 female 2x)
Suction valve control	NO (normally open), sucks when no voltage is applied NC (normally closed), does not suck when no voltage is applied	
Electrical connector	M8 plug, 6-pole JST plug, 5-pole	
Switch function	PNP (switches to plus) NPN (switches to minus)	
Individual configuration code	The 3-digit code “AAA” uniquely describes an ejector disk.	

3.4 Ejector Structure

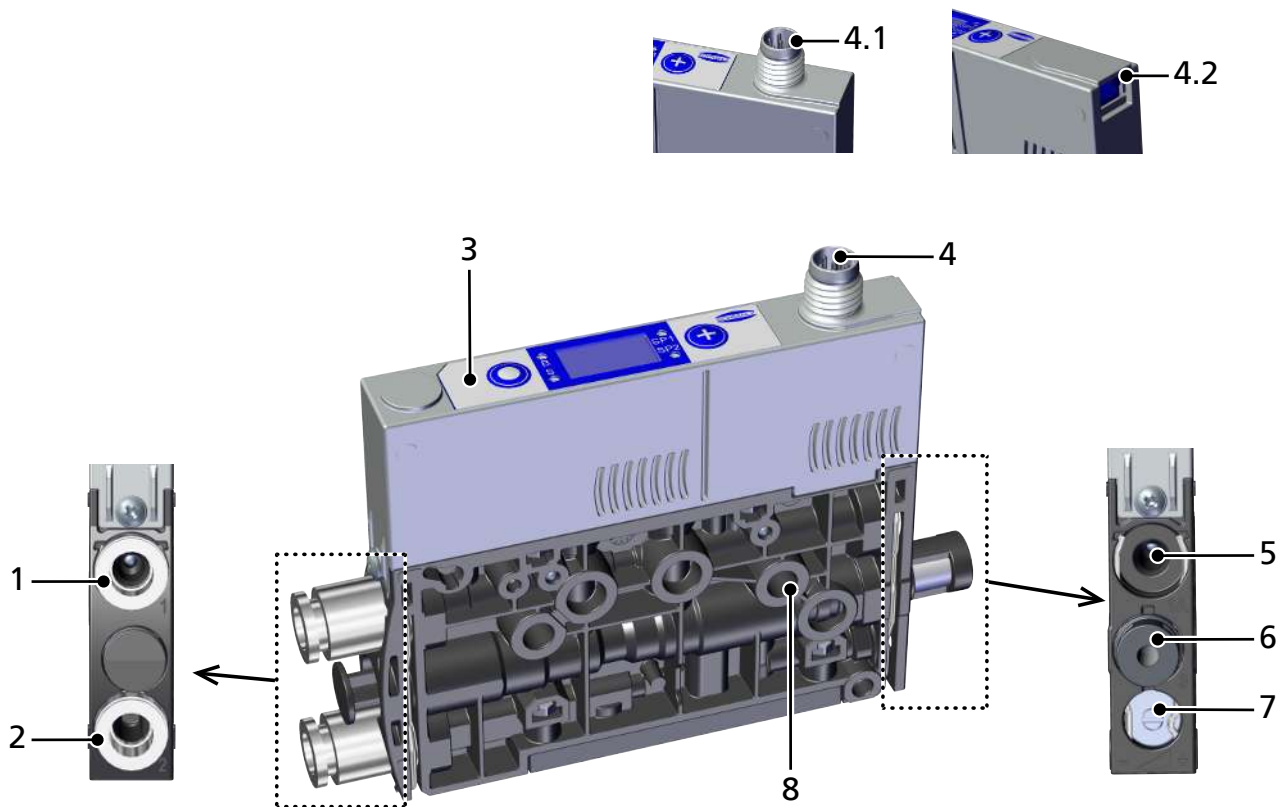

1	Compressed air connector (marking 1)	2	Vacuum connection (marking 2)
3	Operating and display elements	4	4.1 M8 electrical connector, 6-pole 4.2 JST electrical connector, 5-pole
5	Optional: compressed air connector for external blow off EB (marking 1A)	6	Silencer (marking 3)
7	Valve screw for blow off volume flow	8	2x mounting hole

3.5 Controls and Displays in Detail

The ejector is fitted with the following elements to ensure simple operation:

- 2 buttons on the foil keypad
- A 3-digit display
- 4 light-emitting diodes (LEDs) as status indicators

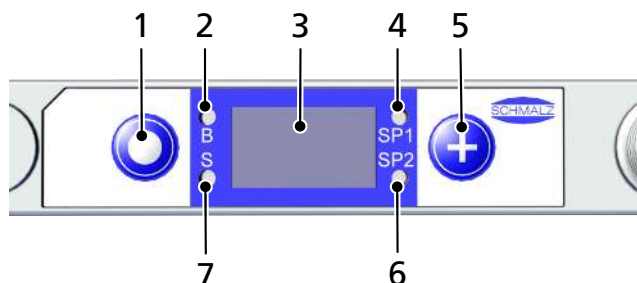

1	MENU BUTTON	2	LED B for blow off state
3	Display	4	LED for switching point limit value SP1
5	UP BUTTON	6	LED for switching point limit value SP2
7	LED S for suction state	—	—





Definition of the LED Indicators

The "suction" and "blow off" process states are each assigned an LED.

Item	Meaning	State	Description
2	Blow off LED B	OFF	Ejector not blowing off
		Lit up	Ejector blowing off
7	Suction LED S	OFF	No suction from ejector
		Lit up	Suction from ejector

The LEDs for the SP1 and SP2 switching points (limit values) indicate the current level of the system vacuum relative to the configured limit values. Their behavior is independent of the control function and the assignment of the output.

The table below explains the meaning of the LEDs:

Item	Limit value LEDs	Ejector state
4 and 6		LEDs both off Rising vacuum: vacuum < SP2 Falling vacuum: vacuum < rP2
4 and 6		SP2 LED lit steadily Rising vacuum: vacuum > SP2 and < SP1 Falling vacuum: vacuum > rP2 and < rP1
4 and 6		Both LEDs lit steadily Rising vacuum: vacuum > SP1 Falling vacuum: vacuum > rP1
4 and 6		Both LEDs flashing Manual control of the "suction" and "blow off" ejector functions. The ejector is in manual mode (> See ch. Manual Mode, Page 24).

4 Technical Data

4.1 Display Parameters

Parameter	Value	Unit	Note
Display	3	Digit	Red 7-segment LED display
Resolution	± 1	mbar	--
Accuracy	± 3	% FS	$T_{amb} = 25^{\circ} \text{C}$, based on FS final value (full-scale)
Display refresh rate	5	1/s	Only affects the 7-segment display
Idle time before the menu is exited	1	min	The display mode is accessed automatically when no settings are made in a menu.

4.2 General Parameters

Parameter	Type	Symbol	Limit value			Unit	Note
			min.	typ.	max.		
Working temperature		T_{amb}	0	—	50	$^{\circ} \text{C}$	—
Storage temperature		T_{sto}	-10	—	60	$^{\circ} \text{C}$	—
Humidity		H_{rel}	10	—	85	% r.h.	Free from condensation
Degree of protection		—	—	—	IP40	—	—
Operating pressure (flow pressure)	03 and 05	P	2	4	6	bar	—
	07 and 10	P	3	4	6	bar	—
Operating medium	Air or neutral gas, filtered to 5 μm , without oil, class 3-3-3 compressed air quality in acc. with ISO 8573-1						

4.3 Electrical Parameters

Supply voltage	DC 24 V \pm 10% (PELV ¹⁾)		
Polarity reversal protection	Yes		
Current consumption (at 24 V)	—	Typical current consumption	Max. current consumption
	SCPMc – xx – NO	50 mA	70 mA
	SCPMc – xx – NC	75 mA	115 mA

¹⁾ The power supply must correspond to the regulations in accordance with EN60204 (protected extra-low voltage).

4.4 Mechanical Data

4.4.1 Performance Data

Type	Nozzle 03	Nozzle 05	Nozzle 07	Nozzle 10
Nozzle size [mm]	0.3	0.5	0.7	1.0
Degree of evacuation [%]	87			
Max. suction rate [l/min] ¹⁾	2.2	7.5	15	28
Air consumption for suction [l/min]	3.5	9	22	45
Air consumption for blow off [l/min]	10			
Sound pressure level, unobstructed suction [dB(A)] ¹⁾	51	66	70	71
Sound pressure level, suction [dB(A)]	42	55	70	72
Pressure range [bar]	2 to 6		3 to 6	
Recommended diameter of compressed air hose [mm] ²⁾	2			4
Recommended diameter of vacuum hose [mm] ²⁾	2			4
Weight [g]	80	85		

¹⁾ At optimal operating pressure (SCPM...03/05/07: 4 bar; SCPM...10: 4.5 bar)

²⁾ For max. length of 2 m

4.4.2 Dimensions

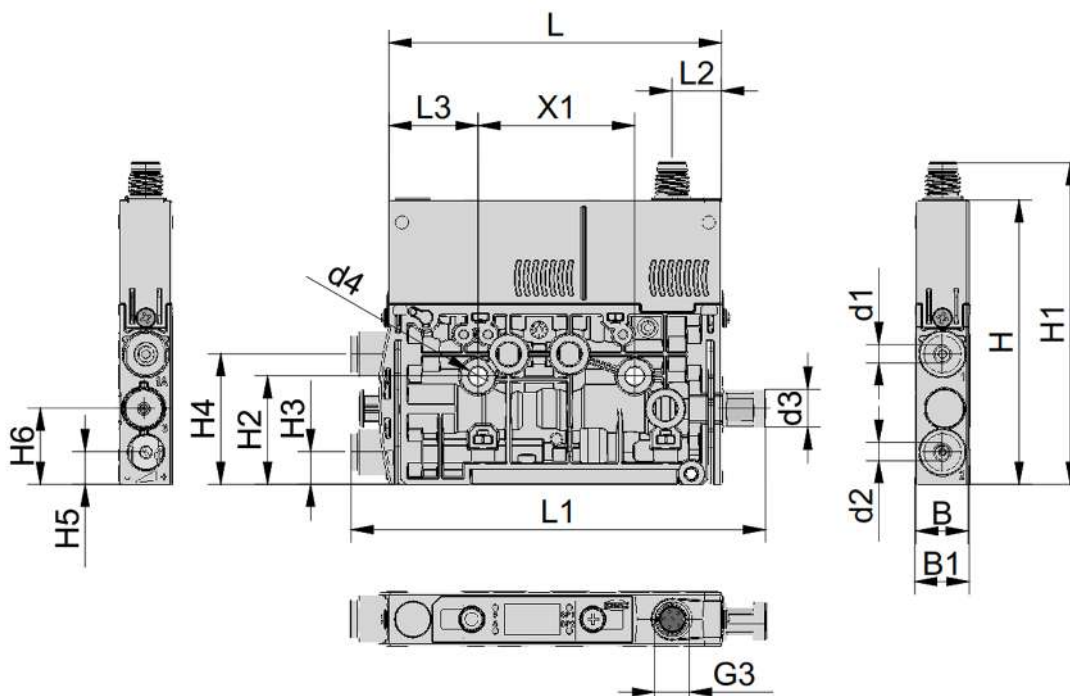

G3	L	B	H	L1	L2	L3	X1	H1	H2
M8x1 male thread	76.5	12	65.3	95.3	11.4	20.5	36	73.9	24.95

H3	H4	H5	H6	d1	d2	d5	d3	d4	B1
7.5	30	7.5	17.5	Depending on the particular ejector, see chapter 3.3 "Ejector designation"			9	4.3	12.5

All specifications are in mm

4.4.3 Maximum Torque

Connection	Max. torque
Mounting hole d4	1 Nm
Electrical connector G3	Hand-tight

4.4.4 Pneumatic circuit plans

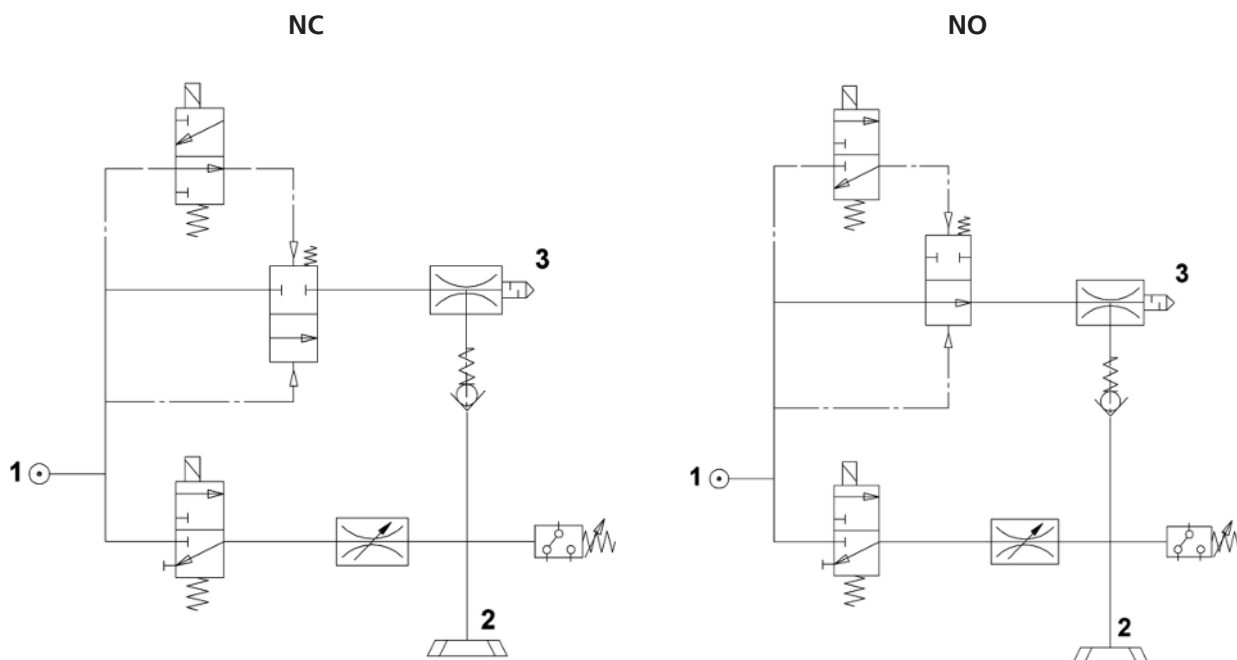

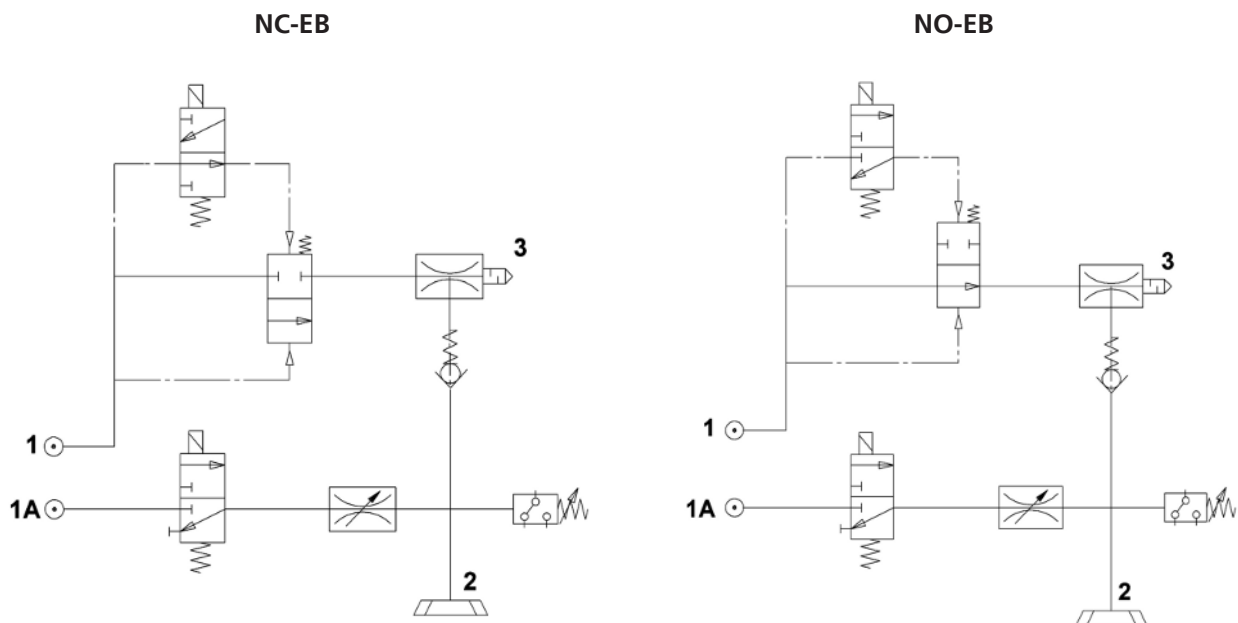

4.4.5 Factory Settings

Code	Parameter	Value of the factory setting
SP 1	Switching point SP1	750 mbar
rP 1	Reset point rP1	600 mbar
SP 2	Switching point SP2	550 mbar
rP 2	Reset point rP2	540 mbar
tBL	Blow off time	0 s
ctr	Control	Activated = 00
t- 1	Evacuation time	0 s
-L -	Leakage value	0 mbar/s
u n i	Vacuum unit	Vacuum unit in mbar = 0.1

5 Operating and Menu Concepts

The ejector is operated using two buttons on the foil keypad:



MENU BUTTON



PLUS BUTTON

Navigation is divided into three menus:

- The main menu: for standard applications
- The Extended Functions (EF) menu: for applications with special requirements
- The Info menu (INF): for reading out system data such as counters, the software version, etc.

If settings are changed, undefined states of the system may occur for a short time (for approx. 50 ms).

The following information can be shown on the display:

- The current vacuum measurement value
- The selected menu item
- The settings
- Error messages in the form of error codes

The operating menu's home screen shows the currently measured vacuum level in the selected display unit. The available units are millibar, kilopascal, inHg and psi. The measured value is displayed as positive compared to the ambient air pressure.

The menus will automatically close if no buttons are pressed for 1 minute.

The display also returns to the home screen when an error occurs so that the error code can be displayed. A menu can be called up and used again afterward.

5.1 Button Assignments in Display Mode



In display mode, a specific function is assigned to each key.

5.1.1 Opening the Menu



Press the **PLUS BUTTON** to open the menus as follows:

- ▶ Press the  button briefly.
- ⇒ The main menu opens with the first parameter [SP l].

Opening the EF menu for extended functions:

1. Press the  button several times until the parameter EF appears on the display.
2. Press the  button to switch to the EF submenu for extended functions.
- ⇒ The EF menu opens with the first parameter [cEr].

Opening the INF menu:

1. Press the  buttons several times until the parameter InF appears on the display.
2. Press the  button to switch to the INF submenu for extended functions.
- ⇒ The INF menu opens with the first parameter [cc l].

5.1.2 Displaying the basic settings (slide show)

When you press the  button from the home screen, the following parameters are automatically displayed one after the other on the display (slide show):

- The vacuum unit
- The value of the switching point SP1
- The value of reset point rP1
- The value of switching point SP2
- The supply voltage US

The display cycle returns to the vacuum display after a complete cycle or can be canceled at any time by pressing any button.

5.2 Main Menu

All settings for standard applications can be accessed and configured using the main menu.





5.2.1 Functions in the Main Menu





The following table shows an overview of the display codes and parameters in the main menu:

Display code	Parameter	Explanation
SP 1	Switching point 1	Value at which the control function deactivates (only active if [c b r] = [0 n])
rP 1	Reset point 1	Reset value 1 for the control function
SP 2	Switching point 2	Switching value for the "Parts control" signal
rP 2	Reset point 2	Reset value 2 for the "Parts control" signal
t b L	Blow off time	Blow off time setting for time-controlled blow off (only active if value > 0)
c AL	Zero-point adjustment (calibration)	Calibrate vacuum sensor, zero point = ambient pressure
EF	Extended functions	Open the "Extended Functions" submenu
INF	Information	Open the "Information" submenu
INC	Incorrect	The entered value is not within the permissible value range. This is an informational message that appears if incorrect information is entered.

5.2.2 Changing the Parameters of the Main menu

If you wish to change values, e.g. the switching points, you have to enter the new value digit by digit.

1. Use the  button to select the desired parameter.
2. Confirm using the  button.
 - ⇒ The currently set value is displayed and the first digit flashes.
3. Use the  button to change the value. The value increases by 1 each time the button is pressed. After 9, the counter goes back to 0 when the  button is pressed.
4. Press the  button to save the modified value.
 - ⇒ The first digit is accepted and the second digit flashes.

5. Use the  button to set the second digit.
6. Press the  button to save the modified value.
 - ⇒ The second digit is accepted and the third digit flashes.
7. Use the  button to set the third digit.
8. Press the  button to save the modified value.
 - ⇒ If the value entered lies within the permissible value range, it is accepted and the modified parameter is displayed.
 - ⇒ If the entered value does not lie within the permissible value range, this is briefly indicated on the display [100] and the new value is not accepted.

If input is interrupted for longer than 1 minute or if no input is made, the display automatically switches to the measurement display.

5.3 Extended Functions menu (EF)

An “Extended Functions” menu (EF) is available for applications with special requirements.

5.3.1 Functions in the Extended Functions menu (EF)



The following table shows an overview of the display codes and parameters in the “Extended Functions” menu:







Display code	Parameter	Possible settings	Explanation
000	Energy-saving function	0FF 00	Control function off Control active
-L-	Max. permissible leakage	Values configurable between 0 and 999	Permitted leakage Unit: millibar per second
E-1	Max. permissible evacuation time	configurable between 0.01 and 9.99 seconds in steps of 0.01 0FF	Permitted evacuation time No monitoring
000	Vacuum unit	mBar kPa inHg PSI	Define the displayed vacuum unit Vacuum level in millibar [mbar] Vacuum level in kilopascal [kPa] Vacuum value in inch of mercury [inHg] Vacuum value in pound-force per square inch [psi]
RES	Reset	no YES	The values remain unchanged Reset parameter values to factory settings

5.3.2 Changing parameters in the Extended Functions menu

Depending on the parameter, there are two different methods for entering values in the EF menu.





When entering numerical values, you enter them digit by digit as in the main menu:

1. Use the  button to select the desired parameter.
2. Confirm using the  button.
 - ⇒ The currently set value is displayed and the first digit flashes.

3. Use the  button to change the value. The value increases by 1 each time the button is pressed.
After 9, the counter goes back to 0 when the  button is pressed.
4. Press the  button to save the modified value.
⇒ The first digit is accepted and the second digit flashes.
5. Use the  button to set the second digit.
6. Press the  button to save the modified value.
⇒ The second digit is accepted and the third digit flashes.
7. Use the  button to set the third digit.
8. Press the  button to save the modified value.
⇒ The value is accepted and the modified parameter is displayed.

If input is interrupted for longer than 1 minute or if no input is made, the display automatically switches to the measurement display.

For other parameters, you can select among predefined settings:

1. Use the  button to select the desired parameter.
2. Confirm using the  button.
⇒ The current setting is displayed and flashes.
3. Use the  button to switch to the next setting.
4. Press the  button to save the desired setting.
⇒ The selected setting is briefly shown on the display.
⇒ The display then automatically jumps to the parameter that was just set.

5.4 Info menu [INF]

The “Info” [INF] menu is available for reading out system data such as counters, the software version, part numbers and serial numbers.

5.4.1 Functions in the Info menu



The following table shows an overview of the display codes and parameters in the Info menu:

Display code	Parameter	Explanation
cc 1	Counter 1	Counter for suction cycles (suction signal input)
cc 2	Counter 2	Valve switching cycles
SoC	Software	Indicates the software version
Art	Article/part number	The part number is displayed
Snr	Serial number	The serial number is displayed Information about the production period

5.4.2 How data is displayed in the info menu

Counter values or numbers with more than 3 digits are displayed in a special manner.

Counter values and serial numbers are 9-digit whole numbers. These numbers are divided into 3 blocks of 3 numbers when shown on the display. Each time a decimal point is displayed to indicate if it is the highest, middle or lowest block. The display starts with the 3 highest-value digits and can be scrolled through using the  button.

1. Use the  button to select the desired parameter.
2. Confirm using the  button.
3. Use the  button to display or scroll through the blocks that make up the value.

6 Description of Functions

6.1 Overview of Functions

Description	Parameter	See section
Operating modes	—	(> See ch. Operating Modes, Page 24) Automatic operation and manual operation
Switching point setting	SP1 / rP1 SP2 / rP2	(> See ch. Monitoring the system vacuum and defining limit values, Page 26)
Calibrate zero point	cAL	(> See ch. Calibrating the sensor, Page 26)
Energy-saving function, control function	cEr	(> See ch. Control functions, Page 26)
Define blow off time	tBL	(> See ch. Blow off modes, Page 27)
Display unit	un i	(> See ch. Selecting the display unit, Page 27)
Reset to factory settings	rES	(> See ch. Reset to factory settings, Page 28)
Counter(s)	cc1 cc2	(> See ch. Counters, Page 28)
Software version	SoC	(> See ch. Displaying the software version, Page 29)
Article/part number	Art	(> See ch. Displaying the part number, Page 29)
Serial number	Snr	(> See ch. Displaying the serial number, Page 30)
Condition monitoring (CM)	t-1 -L-	(> See ch. Condition Monitoring (CM), Page 31)
Optional: external blow off Compressed air connector 1A	—	(> See ch. Optional: External blow-off connection (EB), Page 37)
Error messages	e.g. E03 FFF -FF	(> See ch. Error messages, Page 42)

6.2 Operating Modes

6.2.1 Automatic Mode

Once the ejector is connected to the power supply, it is ready for operation and enters automatic operation mode. This is the normal operating mode, in which the ejector is operated by the system controller.

The operating mode may be changed from automatic to manual mode using the buttons.

Parameterization of the ejector is always performed in automatic mode.

6.2.2 Manual Mode



NOTE

Change the output signals in manual mode

Personal injury or damage to property

- ▶ Electrical connection may be performed only by specialists who can judge the effects of signal changes on the overall system.

In manual mode, the “suction” and “blow off” ejector functions can be controlled independently of the higher-level controller using the buttons on the foil keypad of the operating element. This function is used, among other things, to detect and eliminate leaks in the vacuum circuit.

In this operating mode, the “SP1” and “SP2” LEDs both flash.

Activating Manual Mode



NOTE

Manual mode modified by external signals

Personal injury or damage to property due to unpredictable work steps

- ▶ Ensure that the danger zone of the system is clear of people during operation.

✓ The ejector is on the measurement screen.

- ▶ Press and hold the  and  buttons simultaneously for at least 3 seconds.
- ⇒ The “SP1” and “SP2” LEDs flash.

Deactivating Manual Mode

✓ The ejector is in “manual mode”.

- ▶ Briefly press the  and  buttons at the same time.
- ⇒ The SP1 and SP2 LEDs cease to flash.

The device also exits manual mode when the status of the external signals changes.



When the ejector receives an external signal, it switches to automatic mode.

Activating and Deactivating Manual Suction

Activating manual suction



- ✓ The ejector is in “manual mode”. The SP1 and SP2 LEDs flash.
- ▶ Press the  button to activate “suction” mode.
- ⇒ The suction LED S lights up.
- ⇒ The ejector begins to suck.

Deactivating manual suction

- ✓ The ejector is in “suction” mode.
- ▶ Press the  button again.
- ⇒ The suction process is deactivated.
- ▶ Alternatively, press the  button.
- ⇒ The ejector changes to the “blow off” state for as long as you press the button.

If the controller is on [C E F] = [O R] it uses the configured limit values in “manual” mode as well.

Activating and Deactivating Manual Blow-off

- ✓ The ejector is in “manual mode”.
- ▶ Press and hold the  button.
- ⇒ The blow off LED B lights up.
- ⇒ The ejector blows off as long as the button is pressed.
- ▶ Release the  button to end the blow off.
- ⇒ The blow off process is deactivated.
- ⇒ The blow off LED B is no longer lit.

6.3 Monitoring the system vacuum and defining limit values

The ejector has integrated sensors for measuring the vacuum.

The current vacuum level is shown on the display.

The limit values are set in the main menu using the parameters [SP 1], [rP 1], [SP2] and [rP2].

Limit values SP1 and rP1 are used by the control function to control the vacuum.

Overview of the limit values:

Limit value parameter	Description
SP1	Vacuum switching point
rP1	Vacuum reset point
SP2	Activation value of “Parts control” signal output
rP2	Deactivation value of “Parts control” signal output





6.4 Calibrating the sensor

Since the sensor integrated in the ejector is subject to variation due to the manufacturing process, we recommend calibrating the sensor after installation. In order to calibrate the ejector, the system’s pneumatic circuits must be open to the atmosphere.

A zero offset is only possible in the range of ± 3 percent of the end value of the measuring range.

If the permissible limit of $\pm 3\%$ is exceeded, error code [E03] will appear on the display.

The zero-point adjustment function is executed in the main menu using the parameter [CAL].

1. To adjust the zero point, press the  button several times until [CAL] appears on the display.
2. Confirm using the  button.
3. Use the  button to choose between [r0] and [YES] (calibrate the vacuum sensor).
4. Confirm using the  button.
- ⇒ The sensor is calibrated.

6.5 Control functions

The ejector allows you to conserve compressed air or prevent a too powerful vacuum from being generated. Vacuum generation is interrupted once the configured switching point SP1 is reached. If leakage causes the vacuum to fall below the reset point rP1, vacuum generation resumes.

The **permitted leakage** can be set in mbar/s using the [-L -] parameter in the Extended Functions menu. The leakage is measured from the point when the control function interrupts suction after reaching switching point SP1.

The following operating modes can be set for the control function using the [CFC] parameter in the Extended Functions menu.

6.5.1 No Control (Continuous Suction)

The ejector produces continuous suction with maximum power. This setting is recommended for very porous workpieces, which would otherwise cause the vacuum generator to switch on and off continuously due to the high rate of leakage.

For this mode, the control function is set to [CFC] = [OFF].

6.5.2 Control

The ejector switches off vacuum generation when the switching point SP1 is reached and switches it back on when the vacuum falls below the reset point rP1. The switching point evaluation for SP1 follows the control function. This setting is particularly recommended for airtight workpieces.

For this mode, the control function is set to [CFC] = [ON].

6.6 Blow off modes

You can choose between two blow off modes.

6.6.1 Externally Controlled Blow-Off

The "blow off" valve is controlled directly by the "blow off" command. The ejector switches to blow off mode for as long as the "blow off" signal is present.

The "blow off" signal is given priority over the "suction" signal.

6.6.2 Internally Time-Controlled Blow-Off

The function is activated by setting a blow off time using the [TBL] parameter in the main menu.

The "blow off" valve is automatically activated for the configured time period as soon as the ejector leaves "suction" mode.

The "blow off" signal overrides the "suction" signal, even if the specified blow off time is very long.

6.6.3 Setting the blow off time

The blow off time can be set using the [TBL] parameter in the main menu.

The value displayed indicates the blow off time in seconds. The time can range from 0.01 to 9.99 seconds.

Set the time for time-controlled blow off (only active if value > 0). If you set the value to 0, the ejector is automatically in "externally controlled blow off" mode.

6.7 Selecting the display unit

This function determines the unit in which the vacuum level is displayed.

You can set the function using the [UNIT] parameter in the EF menu.

The following units are available:

Unit	Explanation
bar	The vacuum level is displayed in mbar. The setting for this unit is [BAR].
Pascal	The vacuum level is displayed in kPa. The setting for this unit is [kPA].
Inch of Hg	The vacuum level is displayed in inHg.

Unit	Explanation
	The setting for this unit is [rH9].
psi	The vacuum level is displayed in psi. The setting for this unit is [PS 1].

6.8 Reset to factory settings

This function is used to reset the following configurations to their factory settings:

- the configuration of the ejector
- the initial setup

This function is executed using the parameter [rES] in the EF menu.

The factory settings for the ejector are listed in the Technical Data section.







⚠ WARNING

By activating/deactivating the product, output signals lead to an action in the production process!

Personal injury

- ▶ Avoid possible danger zone.
- ▶ Remain vigilant.

A description of how to reset the ejector to factory settings using the display and operating element follows:

- ✓ The EF menu is open.
1. Use the  button to select the parameter [rES].
 2. Confirm using the  button.
 3. Use the  button to select [4ES] for the parameter value.
 4. Confirm using the  button.
- ⇒ The ejector is reset to the factory settings.

The reset to factory settings function does not affect the following elements:

- The counter readings
- The zero-point adjustment of the sensor

6.9 Counters

The ejector has two internal counters, [cc 1] and [cc 2], which cannot be erased:

Counter 1 increases with each valid pulse at the "suction" signal input, meaning that it counts all the suction cycles during the ejector's service life.

Counter 2 increases each time the "suction" valve is switched on. As a result, the average switching frequency of the air saving function can be determined using the difference between counters 1 and 2.

Designation	Display parameter	Description
Counter 1	[CC 1]	Counter for suction cycles (suction signal input)
Counter 2	[CC 2]	Counter for the "suction valve" switching frequency

Calling up the counter values

- ✓ Select the counter you wish to see in the system menu.
- ▶ Confirm your selection of counter 1 [CC 1] or counter 2 [CC 2] using the  button.
- ⇒ The first three decimal places of the counter total will be displayed (the digits x 10⁶). This corresponds to the three-digit block with the highest value.

Use the  button to display the remaining decimal places of the counter total, in order of descending value. The decimal points show which 3-digit block of the counter total is shown in the display.

The counter total is comprised of the 3-digit blocks taken together:



Displayed section	10 ⁶	10 ³	10 ⁰
Digit block	0.48	6 18	593

The current counter total in this example is 48 618 593.

-  Non-erasable counter readings are saved only every 1000 steps. That means that when the operating voltage is switched off, up to 999 steps of the counter are lost.



6.10 Displaying the software version

The software version indicates the software currently running on the internal controller.

- ✓ The Info menu is open.
- 1. Use the  button to select the [500] parameter.
- 2. Confirm using the  button.
 - ⇒ The software ID is displayed.
- ▶ To exit the function, press the  button.

6.11 Displaying the part number

The part number of the ejector is printed on the label and also stored electronically.

- ✓ The ejector is in the Info menu.
- 1. Use the  button to select the part number parameter A1E.
- 2. Use the  button to confirm the part number parameter A1E.
 - ⇒ The first two digits of the part number are displayed.
- 3. Press the  button again several times.
 - ⇒ The remaining digits of the part number are displayed. The decimal points shown are part of the part number.

-  In the first block displayed, the point on the far right (after the second digit), which is part of the part number, is not displayed for technical reasons.

The part number consists of 4 blocks with a total of 11 digits.

Displayed section	1	2	3	4
Digit block	10	020	200	383

The part number in this example is 10.02.02.00383.

- ▶ To exit the function, press the  button.

6.12 Displaying the serial number

The serial number indicates the production period of the ejector.

- ✓ The ejector is in the Info menu $\text{I} \text{INF}$

1. Use the  button to select the serial number parameter $\text{S} \text{NR}$.

2. Use the  button to confirm the serial number parameter $\text{S} \text{NR}$.

⇒ The first three decimal places of the serial number will be displayed (the digits $\times 10^6$). This corresponds to the three-digit block with the highest value.

3. Press the  button again several times.

⇒ The remaining digits of the serial number are displayed. The decimal points show which 3-digit block of the serial number is shown in the display.

The serial number consists of 3 blocks with a total of 9 digits:

Displayed section	10^6	10^3	10^0
Digit block	900	000	000

In this example, the serial number is: 900000000

- ▶ To exit the Info menu, press the  button.

6.13 Condition Monitoring (CM)

6.13.1 Evacuation Time Monitoring

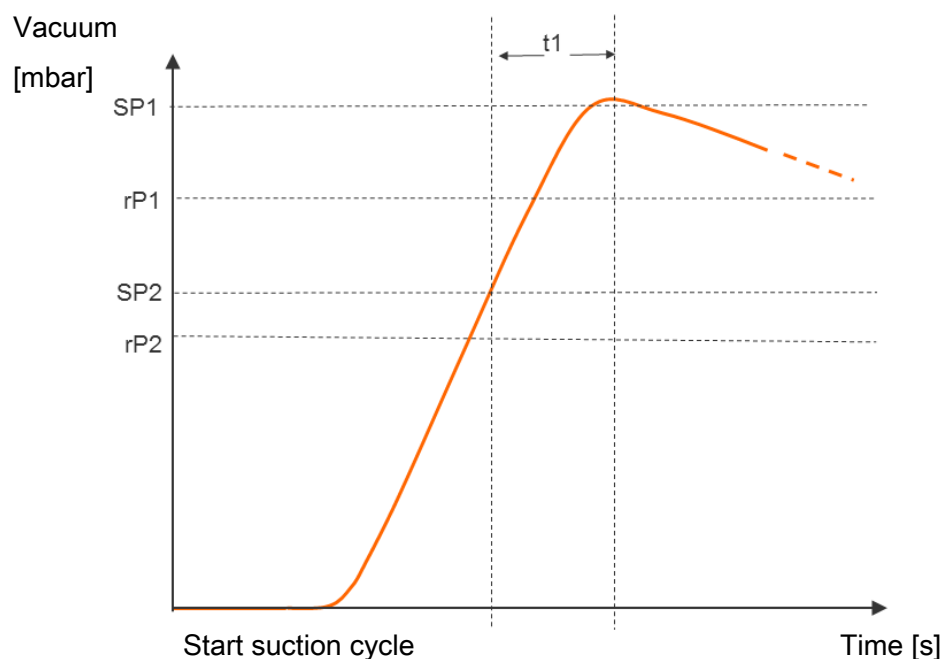

Measuring the evacuation time t_1 :

The interval between reaching the switching points SP2 and SP1 is measured (in ms).

The specified value for the max. permitted evacuation time can be set in the Extended Functions menu with the parameter [E - 1]. Setting the value to [000] (= off) deactivates monitoring. The maximum permitted evacuation time setting is 9.99 s.

If the measured evacuation time t_1 exceeds the specified value (>000), the display alternately shows E - 1 and the vacuum level.

After 5 correctly measured evacuation times, the error message E - 1 is reset. The message is also immediately deleted if you set the permissible evacuation time to the value 000.

6.13.2 Leakage monitoring

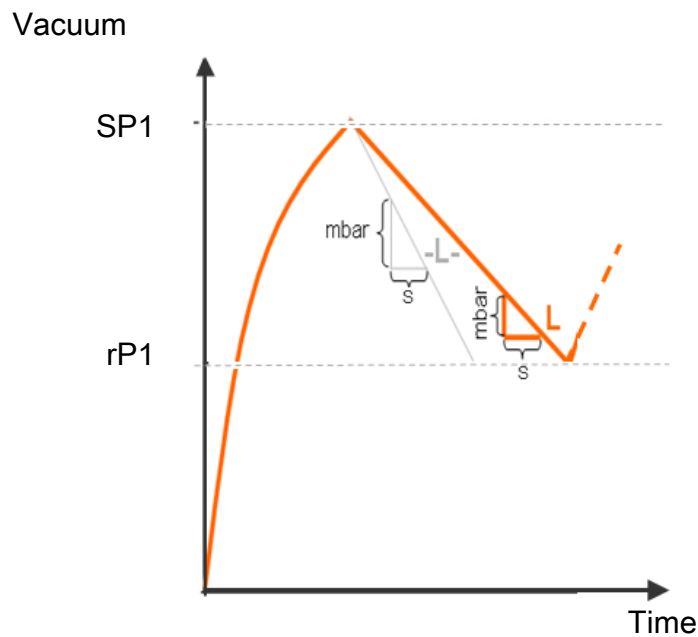

Measuring the leakage:

In control mode ($[C\bar{L}r] = [OK]$), the vacuum drop/leakage over a certain period of time is measured (as vacuum drop per unit time in mbar/s) from the point when the air saving function interrupts suction after reaching switching point SP1.

The specified value for the max. permitted leakage -L- can be set in the Extended Functions menu with the parameter $[-L-]$. Setting the value to $[0000]$ (= off) deactivates monitoring. The maximum leakage that can be set is 999 mbar/second.

If the leakage L is greater than the set value -L-, the display will alternately show $-L-$ and the vacuum level.

The $-L-$ error message is reset after 5 airtight suction cycles (measured leakage value < specified value). The message is also immediately deleted if you set the permissible leakage to the value 0000 .

7 Transport and storage

7.1 Checking the Delivery

The scope of delivery can be found in the order confirmation. The weights and dimensions are listed in the delivery notes.

1. Compare the entire delivery with the supplied delivery notes to make sure nothing is missing.
2. Damage caused by defective packaging or in transit must be reported immediately to the carrier and J. Schmalz GmbH.

8 Installation

8.1 Installation Instructions



CAUTION

Improper installation or maintenance

Personal injury or damage to property

- ▶ During installation and maintenance, make sure that the ejector is disconnected and depressurized and that it cannot be switched on again without authorization.

For safe installation, the following instructions must be observed:

1. Use only the connections, mounting holes and attachment materials that have been provided.
2. Carry out mounting and removal only when the device is in an idle, depressurized state.
3. Pneumatic and electrical line connections must be securely connected and attached to the ejector.

8.2 Installation

The ejector may be installed in any position.

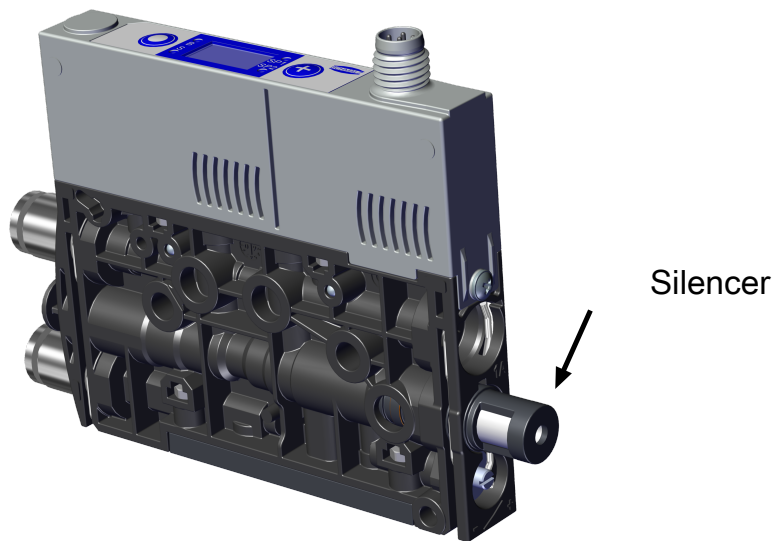

When installing the ejector, make sure that the area around the silencer remains free, so that unimpeded discharge of the escaping air is ensured.

The ejector is usually mounted using the holes on the side. Alternatively, it can be mounted using a DIN rail or a mounting bracket (> See *ch. Accessories, Page 47*):

Side mounting

- ▶ There are two 4.4 mm through-holes for mounting the ejector. Use screws at least 20 mm in length. Use washers if you are using M4 fastening screws for the mounting process. The ejector is to be fixed with at least 2 screws, the maximum tightening torque is 1 Nm.

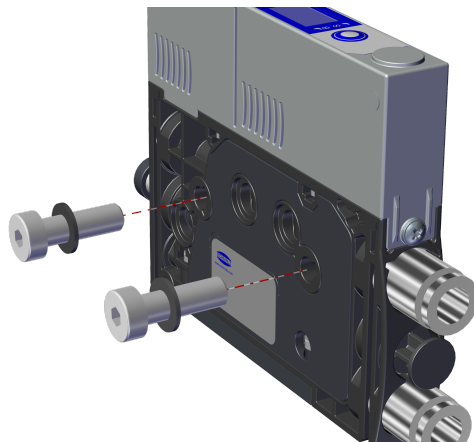

For start of operations, the ejector must be connected to the controller via the connection plug with a connection cable. The compressed air supply must be supplied by the higher-level machine.

The installation process is described and explained in detail below.

8.3 Pneumatic Connection



⚠ CAUTION

Compressed air or vacuum in direct contact with the eye

Severe eye injury

- ▶ Wear eye protection
- ▶ Do not look into compressed air openings
- ▶ Do not look into the silencer air stream
- ▶ Do not look into vacuum openings, e.g. suction cups



⚠ CAUTION

Noise pollution due to incorrect installation of the pressure and vacuum connections

Hearing damage

- ▶ Correct installation.
- ▶ Wear ear protectors.

8.3.1 Connecting the Compressed Air and Vacuum

Description of the pneumatic connection

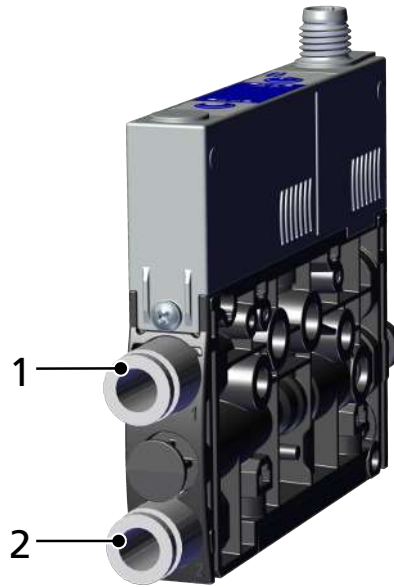

1 Compressed air connector (marking 1)	2 Vacuum connection (marking 2)
--	---------------------------------

The threaded or push-in compressed air connector is marked with the number 1 on the ejector.

- ▶ Connect compressed air hose. For threaded connectors, the maximum tightening torque is 1 Nm.

The threaded or push-in vacuum connector is marked with the number 2 on the ejector.

- ▶ Connect the vacuum hose. For threaded connectors, the maximum tightening torque is 1 Nm.

8.3.2 Instructions for the Pneumatic Connection

To ensure problem-free operation and a long service life of the ejector, only use adequately maintained compressed air and consider the following requirements:

- Use air or neutral gas in accordance with EN 983, filtered to 5 µm, unoled.
 - Dirt particles or foreign bodies in the ejector connections, hoses or pipelines can lead to partial or complete ejector malfunction.
1. Shorten the hoses and pipelines as much as possible.
 2. Keep hose lines free of bends and crimps.
 3. Use only pipes or hoses with the recommended inner diameter to connect the ejector:

Use hoses with sufficient internal diameter...	Internal Ø for nozzle size 0.3 / 0.5 / and 0.7 mm	Internal Ø for nozzle size 1 mm
on the compressed air side to ensure that the ejector achieves its performance data.	4 mm	6 mm
on the vacuum side to avoid high flow resistance. If the internal diameter is too small, the flow resistance and the evacuation times increase and the blow off times are extended.	4 mm	6 mm

Internal diameters are based on a maximum hose length of 2 m.

8.3.3 Optional: External blow-off connection (EB)

The ejector is also optionally available with an additional compressed air connector for the blow off function.

With the external blow off function (EB), the blow off pulse is controlled separately and independently of the compressed air supply for vacuum generation, allowing you to use a different medium (e.g. nitrogen) for the blow off function.

It also allows you to precisely set the blow off pressure using an external pressure regulator (between 2 and 6 bar).

The blow off flow rate can also be set between 0% and 100% directly on the ejector. This can be used, for example, to set down small and lightweight workpieces with high positioning precision.

The hose size and the thread on the connector depend on the particular ejector and can have the following dimensions:

- Push-in: 4/2
- M5 female thread

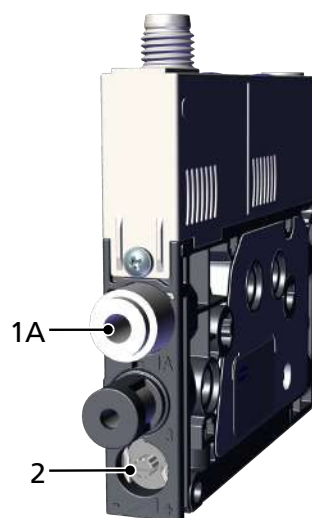

- ▶ Connect the compressed air hose for external blow off (connector marked with 1A) and adjust the blow off flow rate using the adjusting screw (2).

8.4 Electrical Connection



NOTE

Change of output signals when product is switched on or plug is connected

Personal injury or damage to property

- ▶ Electrical connection may be performed only by a qualified specialist who can predict the effects that signal changes will have on the entire system.



NOTE

Incorrect power supply

Destruction of the integrated electronics

- ▶ Operate the product using a power supply unit with protected extra-low voltage (PELV).
- ▶ The system must incorporate safe electrical cut-off of the power supply in compliance with EN60204.
- ▶ Do not connect or disconnect the connector under tension and/or when voltage is applied.

The electrical connection supplies the ejector with power and communicates with the control system of the higher-level machine using defined outputs.

Establish the ejector’s electrical connection using plug connector 1 as shown in the figure.

- ✓ Provide a connection cable with an M8 6-pole socket (customer’s responsibility).

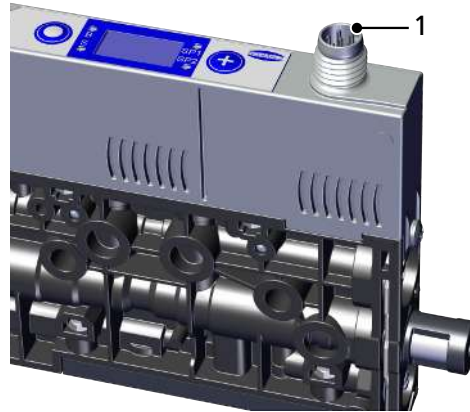

- ▶ Attach the connection cable to the ejector, maximum tightening torque = hand-tight.

For ejectors with a JST plug, establish the ejector’s electrical connection using plug connector 1 as shown in the figure.

- ✓ Provide a connection cable with a 5-pole JST plug (customer’s responsibility).

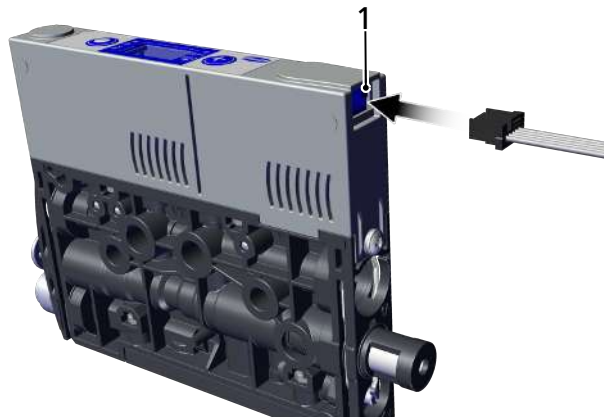

- ▶ Attach the connection cable to the ejector.

Ensure that the electrical cable does not exceed the maximum length of 20 meters.

8.4.1 Pin assignments

M8 plug	Pin	Symbol	Wire color ¹⁾	Function
	1	US	Brown	24 V power supply
	2	IN1	White	“Suction” signal input
	3	GND	Blue	Ground
	4	OUT	Black	“Parts control” output (SP2)
	5	IN2	Gray	“Blow off” signal input
	6	—	Pink	Not used

¹⁾ When using a Schmalz connection cable, part no. 21.04.05.00488 (see accessories)

JST socket	Pin	Symbol	Wire color ¹⁾	Function
	1	US	Brown	24 V power supply
	2	IN1	White	"Suction" signal input
	3	GND	Blue	Ground
	4	OUT	Black	"Parts control" output (SP2)
	5	IN2	Gray	"Blow off" signal input

9 Operation

9.1 General Preparations



⚠ WARNING

Extraction of hazardous media, liquids or bulk material

Personal injury or damage to property!

- ▶ Do not extract harmful media such as dust, oil mists, vapors, aerosols etc.
- ▶ Do not extract aggressive gases or media such as acids, acid fumes, bases, biocides, disinfectants or detergents.
- ▶ Do not extract liquids or bulk materials, e.g. granulates.

Always carry out the following tasks before activating the system:

1. Before each use, check that the safety devices are in perfect condition.
2. Check the ejector for visible damage and deal with any problems immediately (or notify your supervisor).
3. Ensure that only authorized personnel are present in the working area of the machine or system and that no other personnel are put in danger by switching on the machine.

There must be no people in the system danger area while it is in operation.

9.2 Changing the Blow-Off Flow Rate on the Ejector



Do not overwind past the stop on the valve screw. The blow off flow rate can be adjusted within the range between 0% and 100%.

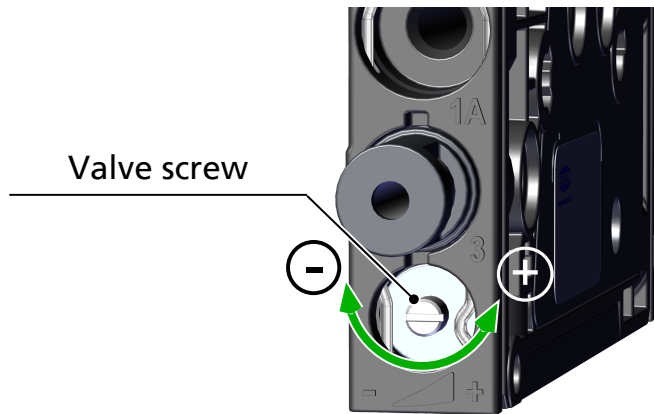

The figure shows the position of the valve screw, which can be used to adjust the blow off flow rate. The valve screw is equipped with a stop on both sides.

1. Turn the valve screw clockwise to reduce the flow rate.
2. Turn the valve screw counterclockwise to increase the flow rate.

10 Troubleshooting

10.1 Help with Malfunctions

Malfunction	Possible cause	Solution
Power supply disrupted	Electrical connector	▶ Make sure device is properly connected to power
No communication	Incorrect electrical connection	▶ Check electrical connection and pin assignment
	Higher-level controller not correctly configured	▶ Check the controller configuration
Ejector does not respond	No power supply	▶ Check electrical connection and pin assignment
	No compressed air supply	▶ Check the compressed air supply
Vacuum level is not reached or vacuum is built up too slowly	Silencer is dirty	▶ Replace the silencer
	Leakage in hose line	▶ Check hose connections
	Leakage at suction cup	▶ Check suction cup
	Operating pressure too low	▶ Increase operating pressure. Note the maximum limits!
	Internal diameter of hose line too small	▶ Observe recommendations for hose diameter
Load cannot be held	Vacuum level too low	▶ Increase the control range for the air saving function
	Suction cup too small	▶ Select a larger suction cup
No display on the screen	Faulty electrical connection	▶ Check electrical connection and pin assignment
Display shows error code	See "Error codes" table	▶ See "Error Codes" table in the following chapter
Warning message "Leakage too high" even though handling cycle is working optimally	Limit value -L- (permissible leakage per second) set too low	▶ Determine typical leakage values in a good handling cycle and set as limit value
	Limit values SP1 and rP1 for leakage measurement set too low	▶ Set limit values in such a way that there is a clear differentiation between the neutral and suction system states.
Warning message "Leakage too high" does not appear although there is high leakage in the system	Limit value -L- (permissible leakage per second) set too high	▶ Determine typical leakage values in a good handling cycle and set as limit value
	Limit values SP1 and rP1 for leakage measurement set too high.	▶ Set limit values in such a way that there is a clear differentiation between the neutral and suction system states.

10.2 Error messages

If a known error occurs, it is reported/shown on the display.

The following table shows all of the error codes:

Code displayed	Explanation
E03	Zero-point adjustment of the vacuum sensor outside $\pm 3\%$ FS
E07	Supply voltage is too low
E17	Supply voltage is too high
FFF	Present vacuum exceeds the measurement range
-FF	Overpressure in vacuum circuit, this normally happens exclusively in blow off mode.
t-1	The measured evacuation time t1 exceeds the specified value, the display alternately shows t-1 and the vacuum level.
-L-	The leakage L is greater than the set value -L-, the display will alternately show -L- and the vacuum level.

11 Maintenance

11.1 Safety

Maintenance work may only be carried out by qualified personnel.



WARNING

Risk of injury due to incorrect maintenance or troubleshooting

- ▶ Check the proper functioning of the product, especially the safety features, after every maintenance or troubleshooting operation.



NOTE

Incorrect maintenance work

Damage to the ejector!

- ▶ Always switch off supply voltage before carrying out any maintenance work.
- ▶ Secure it so that it cannot be switched back on.
- ▶ The ejector must only be operated with a silencer.

- ▶ Before carrying out any work on the system, ensure that the ejector's compressed air circuit is vented to atmospheric pressure!

11.2 Cleaning the Ejector

1. For cleaning, do not use aggressive cleaning agents such as industrial alcohol, white spirit or thinners. Only use cleaning agents with pH 7–12.
2. Remove dirt on the exterior of the device with a soft cloth and soap suds at a maximum temperature of 60° C. Make sure that the silencer is not soaked in soapy water.
3. Ensure that no moisture can reach the electrical connection or other electrical components.

11.3 Replacing the Silencer

Heavy infiltration of dust, oil, etc. may contaminate the silencer and reduce the suction capacity. Cleaning the silencer is not recommended due to the capillary effect of the porous material.

If the suction capacity decreases, replace the silencer:

- ✓ Deactivate the ejector and depressurize the pneumatic systems.

1. Place a small flat screwdriver on the ejector as shown and loosen the clamp.

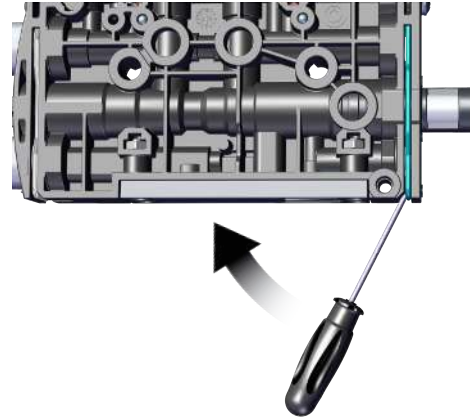

2. Remove the clamp.



3. Then remove the silencer and filter from the ejector.

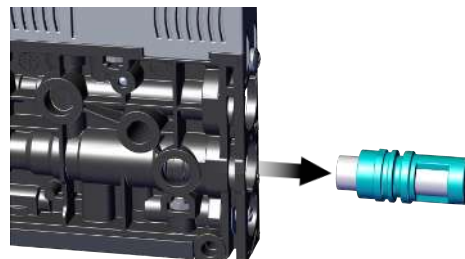

4. Pull the filter out of the housing and dispose of it.



5. Insert the new filter into the housing and reinstall the silencer.



6. Mount the clamp in the correct position!



- ⇒ The clamp is mounted flush with the underside of the ejector and the clamp legs both lie in the grooves. It does not protrude from the ejector.



7. Check that the silencer is held tightly by pulling on the housing (hand-tight).

12 Warranty

This system is guaranteed in accordance with our general terms of trade and delivery. The same applies to spare parts, provided that these are original parts supplied by us.

We are not liable for any damage resulting from the use of non-original spare parts or accessories.

The exclusive use of original spare parts is a prerequisite for the proper functioning of the ejector and for the validity of the warranty.

Wearing parts are not covered by the warranty.

Opening the ejector will damage the "tested" labels. This voids the warranty.

13 Spare and Wearing Parts, Accessories

13.1 Spare and Wearing Parts

Maintenance work may only be carried out by qualified personnel.



⚠ WARNING

Risk of injury due to incorrect maintenance or troubleshooting

- ▶ Check the proper functioning of the product, especially the safety features, after every maintenance or troubleshooting operation.

The following list contains the primary spare and wearing parts.

Designation	Part no.	Type
Silencer	10.02.02.05403	W
NO ejector suction valve for nozzle size 03/05	10.05.01.00394	S
NO ejector suction valve for nozzle size 07/10	10.05.01.00382	S
NC ejector suction valve for nozzle size 03/05	10.05.01.00382	S
NC ejector suction valve for nozzle size 07/10	10.05.01.00394	S
Blow off valve (NC valve)	10.05.01.00382	S

Legend:	S ...	Spare part
	W ...	Wearing part

When tightening the fastening screws on the valves, observe the maximum tightening torque of 0.1 Nm.

13.2 Accessories

Designation	Part no.	Note
Connection cable, ASK WB-M8-6 2000 K-6P	21.04.05.00488	M8 socket, 6-pole; length: 2000 mm; open cable end, 6-pole; 90° angle
Connection cable, ASK B-M8-6 5000 K-6P	21.04.05.00255	M8 socket, 6-pole; length: 5000 mm; open cable end, 6-pole
Connection cable, ASK WB-M8-6 2000 S-M12-5	21.04.05.00489	M8 socket, 6-pole; cable length: 2000 mm; M12 plug, 5-pole; 90° angle
M5 plug-in screw union	10.08.02.00468	—
M7 plug-in screw union	10.08.02.00469	—
DIN rail mounting kit	10.02.02.05804	—
Mounting kit (mounting bracket)	10.02.02.05803	—

14 Decommissioning and recycling

14.1 Disposing of the Ejector

1. Dispose of the product properly after replacement or decommissioning.
2. Observe the country-specific guidelines and legal obligations for waste prevention and disposal.

14.2 Materials Used

Component	Material
Housing	PA6-GF
Inner components	Aluminum alloy, anodized aluminum alloy, stainless steel, POM
Controller housing	PC/ABS
Silencer insert	Porous PE
Screws	Galvanized steel
Sealing	Nitrile rubber (NBR)
Lubrication	Silicone-free

15 Appendix

15.1 Overview of Display Codes

Display code	Parameter	Comment
SP 1	Switching point 1	Value at which the control function deactivates
rP 1	Reset point 1	Reset value 1 for the control function
SP2	Switching point 2	Activation value of "Parts control" signal output
rP2	Reset point 2	Reset value 2 for the "Parts control" signal
tBL	Blow off time	Set the blow off time for time-controlled blow off
cAL	Zero-point adjustment	Calibrate the vacuum sensor
EF	Extended functions	Open the "Extended Functions" submenu
INF	Information	Open the "Info" submenu
cc 1	Counter 1	Counter for suction cycles (suction signal input)
cc 2	Counter 2	Counter for valve switching frequency
SoC	Software	Displays the software version
Snr	Serial number	Displays the serial number of the ejector
Art	Article/part number	Displays the part number of the ejector
un i	Vacuum unit	Vacuum unit in which the measurement and setting values are displayed
bAr	Vacuum level in mbar	The displayed vacuum is shown in mbar.
PS i	Vacuum level in psi	The displayed vacuum level is shown in psi.
iHg	Vacuum level in inHg	The displayed vacuum is shown in inches of Hg.
kPa	Vacuum level in kPa	The displayed vacuum level is shown in kPa.
t- 1	Max. permissible evacuation time	Set the maximum permitted evacuation time
-L-	Max. permissible leakage	Set the maximum permissible leakage in mbar/s
cEr	Control	Set the air saving function (control function)
rES	Reset	All values are reset to the factory settings.
InC	Inconsistent	The entered value is not within the permissible value range. This is an informational message that appears if incorrect information is entered.
0Or	Out of range	Input value invalid

15.2 EC declaration of conformity

EC Declaration of Conformity

The manufacturer Schmalz confirms that the Ejector described in these operating instructions fulfill the following applicable EC directives:

2014/30/EU	Electromagnetic Compatibility
2011/65/EU	Directive on the restriction of the use of certain hazardous substances in electrical and electronic equipment

The following harmonized standards were applied:

EN 61000-6-4	Electromagnetic Compatibility - Emission
EN 61000-6-2	Electromagnetic Compatibility – Immunity
EN 61000-4-2	Electromagnetic Compatibility (EMC) – Part 4-2: Testing and measuring procedures

At your side worldwide

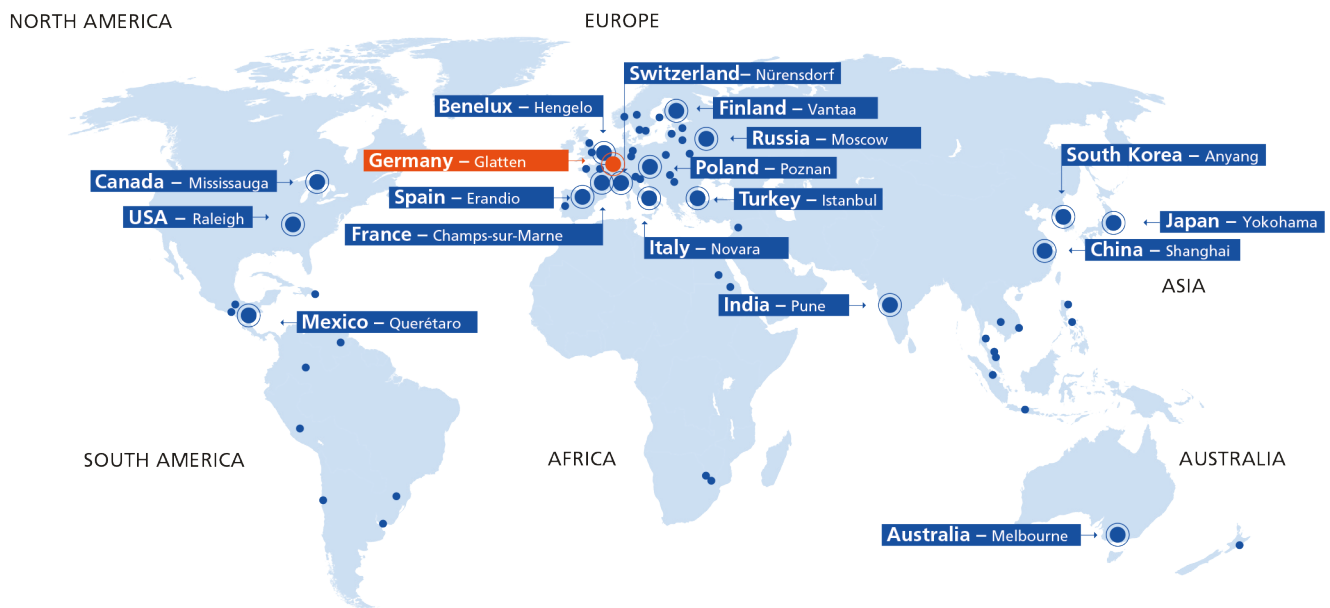

Headquarters

Schmalz Germany – Glatten

Sales Partners

You can find the Schmalz sales partner in your country at:
WWW.SCHMALZ.COM/SALESNETWORK

Subsidiaries

- Schmalz Australia – Melbourne
- Schmalz Benelux – Hengelo (NL)
- Schmalz Canada – Mississauga
- Schmalz China – Shanghai
- Schmalz Finland – Vantaa
- Schmalz France – Champs-sur-Marne
- Schmalz India – Pune
- Schmalz Italy – Novara
- Schmalz Japan – Yokohama

- Schmalz Mexico – Querétaro
- Schmalz Poland – Suchy Las (Poznan)
- Schmalz Russia – Moscow
- Schmalz South Korea – Anyang
- Schmalz Spain – Erandio (Vizcaya)
- Schmalz Switzerland – Nürens Dorf
- Schmalz Turkey – Istanbul
- Schmalz USA – Raleigh (NC)

Vacuum Automation

WWW.SCHMALZ.COM/AUTOMATION

Handling Systems

WWW.SCHMALZ.COM/HANDLINGSYSTEMS

J. Schmalz GmbH
 Johannes-Schmalz-Str. 1
 72293 Glatten, Germany
 T: +49 7443 2403-0
 schmalz@schmalz.de
 WWW.SCHMALZ.COM