

Flat suction cup (round)

SUF 12 HT1-60 M5-AG

Part no.:10.01.01.14178

<https://www.schmalz.com/10.01.01.14178>

Homepage > Vacuum Technology for Automation > Vacuum Components > Vacuum Suction Cups > Flat suction cup (round) > Suction Cups

SUF > SUF 12 HT1-60 M5-AG

Flat suction cup (round) for process safe handling of smooth or slightly rough surfaces



Size: 12

Suction cup material:

High temp material HT1

Material hardness: 60 °Sh

Design Data

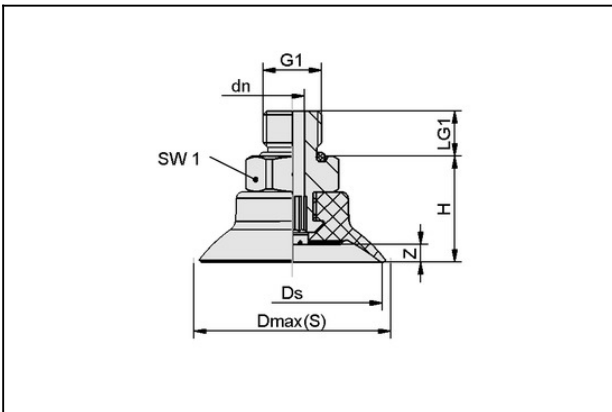

Attribute	Value
Dmax(S)	13.2 mm
Ds	12 mm
dn	1.8 mm
G1	M5-M
H	13.6 mm
LG1	4.7 mm
SW1	8 mm
Z (Stroke)	1.2 mm

Technical Data

Contact to Schmalz

J. Schmalz GmbH | Johannes-Schmalz-Straße, 72293 Glatten, Deutschland | +49 7443 2403-102 | customercenter@schmalz.de

Flat suction cup (round)

SUF 12 HT1-60 M5-AG

Part no.:10.01.01.14178

<https://www.schmalz.com/10.01.01.14178>

Attribute	Value
Size	12
Suction cup material	High temp material HT1
Material hardness [Shore A]	60 Shore A
Abreißkraft (real)	5.4 N

Spare Parts



SC 030 M5-AG

Part no.10.01.06.02802

Connection element for suction cup "SchmalzConnector"

Connection geometry: 030

Vacuum connection: M5-M

Overall length: 15.5 mm

Fitting length: 5 mm

Nominal diameter dn: 1.8 mm

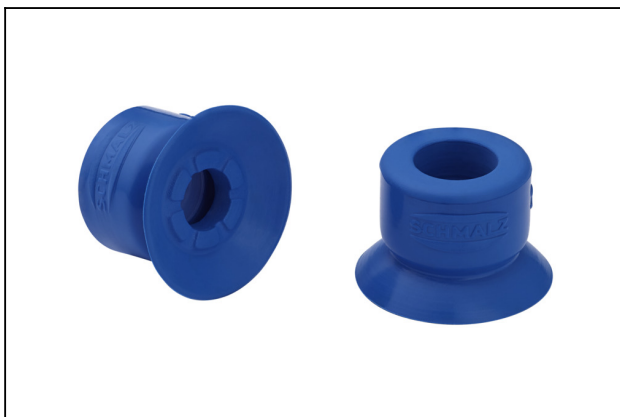

SUF 12 HT1-60 SC030

Part no.10.01.01.13988

Flat suction cup (round) f. process- safe handling of smooth or slightly rough surfaces

Size: 12

Suction cup material:

High temp material HT1

Material hardness: 60 °Sh