

Flat suction cup (round)

SUF 5 SI-55 M5-AG

Part no.:10.01.01.14224

<https://www.schmalz.com/10.01.01.14224>

Homepage > Vacuum Technology for Automation > Vacuum Components > Vacuum Suction Cups > Flat suction cup (round) > Suction Cups

SUF > SUF 5 SI-55 M5-AG

Flat suction cup (round) for process safe handling of smooth or slightly rough surfaces



Size: 5

Suction cup material: Silicone SI

Material hardness: 55 °Sh

Design Data

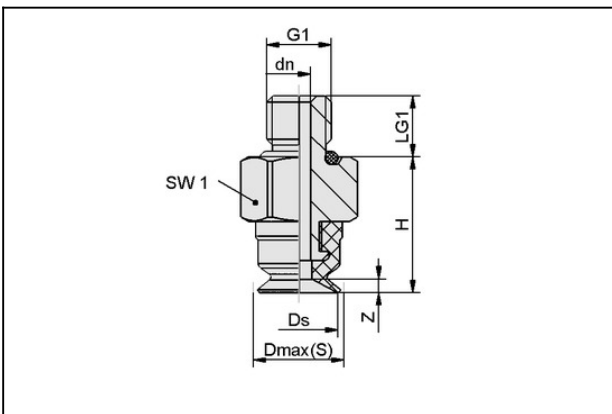

Attribute	Value
Dmax(S)	5.7 mm
Ds	5 mm
dn	1.8 mm
G1	M5-M
H	10.5 mm
LG1	4.7 mm
SW1	5 mm
Z (Stroke)	0.5 mm

Technical Data

Contact to Schmalz

J. Schmalz GmbH | Johannes-Schmalz-Straße, 72293 Glatten, Deutschland | +49 7443 2403-102 | customercenter@schmalz.de

Flat suction cup (round)

SUF 5 SI-55 M5-AG

Part no.:10.01.01.14224

<https://www.schmalz.com/10.01.01.14224>



Attribute	Value
Size	5
Suction cup material	Silicone SI
Material hardness [Shore A]	55 Shore A
Abreißkraft (real)	0.9 N

Spare Parts

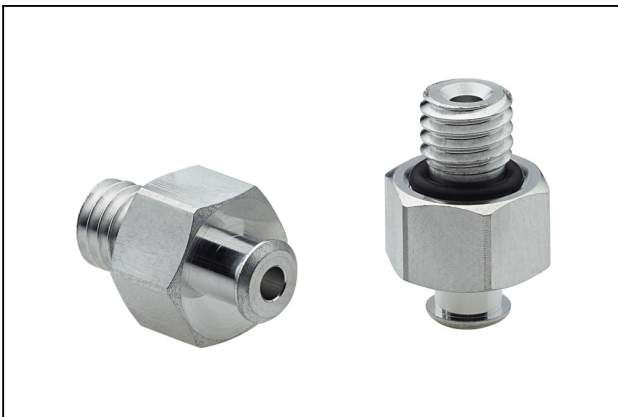

SC 020 M5-AG

Part no.10.01.06.04273

Connection element for suction cup "SchmalzConnector"

Connection geometry: 020

Vacuum connection: M5-M

Overall length: 12.7 mm

Fitting length: 5 mm

Nominal diameter dn: 1.8 mm



SUF 5 SI-55 SC020

Part no.10.01.01.13962

Flat suction cup (round) f. process- safe handling of smooth or slightly rough surfaces

Size: 5

Suction cup material: Silicone SI

Material hardness: 55 °Sh