

# RECESSED PULL

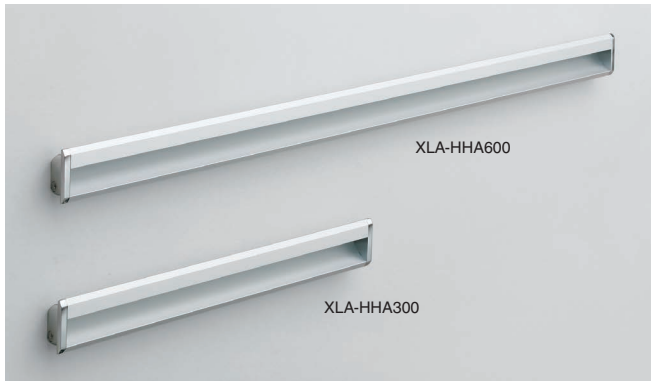

## XLA-HHA



### Features

- Long recessed handle available in two sizes: 300 and 600mm.
- Length can be freely changed by cutting the handle to the appropriate length.
- Straight linear design provides a visually appealing design that integrates very easily.
- Custom sizes are available, please contact us for details.

### Parts Included

Truss head screw M4x10 (SUS)

### Sold Separately

Bracket for sheet metal XLA-HHA40B

### Cut Out Dimensions (For Wood)

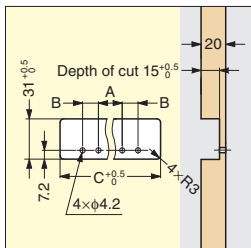

### Sheet Metal Mounting Application

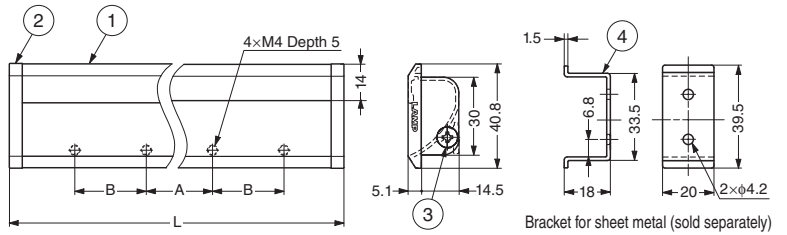
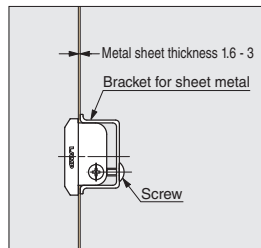

No.	Part Name	Material	Finish
①	Body	Aluminium Alloy	Silver Anodized
②	Cover	Zinc Alloy (ZDC)	Chrome
③	Screw	Stainless Steel	-
④	Bracket (Option)	Stainless Steel (SUS430)	Polished

### Body

Item Code	Item Name	L	A	B	C	Weight	Box
100-010-190	XLA-HHA300	300	100	50	297	140 g	100 pcs
100-010-191	XLA-HHA600	600	200	150	597	245 g	50 pcs

### Bracket for Sheet Metal (Sold Separately)

Item Code	Item Name
100-010-189	XLA-HHA40B

# RECESSED PULL W/ TOGGLE FINGER PROTECTOR



## HH-P135

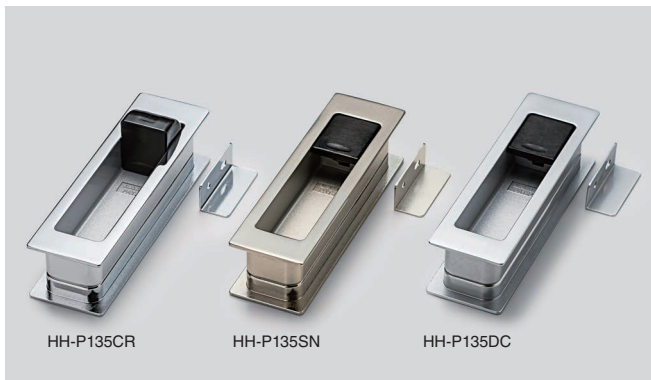

### Features

- Recessed pull with finger protector. Finger protector can be toggled on and off. When it is toggled on, the pull protects fingers from being caught inside the pull's recessed area while closing sliding doors.
- When people in wheelchairs are passing, the switch can be toggled off, allowing the sliding door to fully open. This supports barrier-free design.
- Can be used on doors that are between 40-50mm thick. (Requires longer screws)

### Remarks

In case using with counter plate, set the gap (\*) 7 mm.

### Parts Included

Countersunk head screw M4x25

Countersunk head tapping screw 4x20

### Cut Out Dimensions

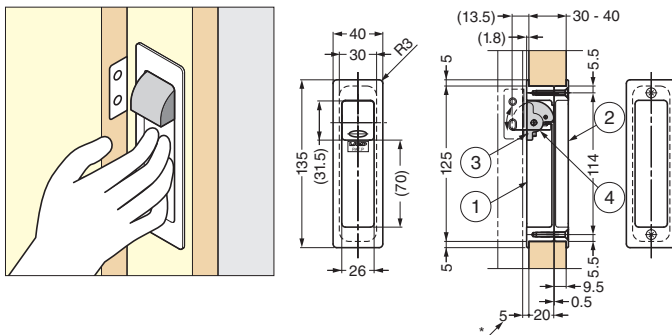
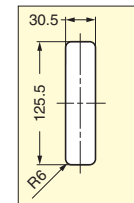

No.	Part Name	Material	Finish/Colour
①	Pull A	Zinc Alloy (ZDC)	Satin Nickel, Chrome, Dull Chrome
②	Pull B		
③	Protector	Polyurethane (PUR)	Black
④	Shaft	Stainless Steel (SUS304)	Plain
⑤	Counter Plate	Steel (SPCC)	Satin Nickel, Chrome, Dull Chrome
⑥	Plate Spacer	ABS	Gray

Item Code	Item Name	Finish	Door Thickness	Weight	Box	Carton
100-010-096	HH-P135SN	Satin Nickel	30 - 40	290 g	5 pcs	50 pcs
100-010-097	HH-P135CR	Chrome	30 - 40	290 g	5 pcs	50 pcs
100-010-098	HH-P135DC	Dull Chrome	30 - 40	290 g	5 pcs	50 pcs