

RECESSED PULL

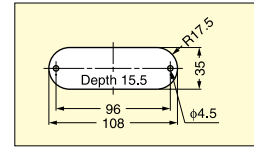

HH-D

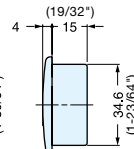
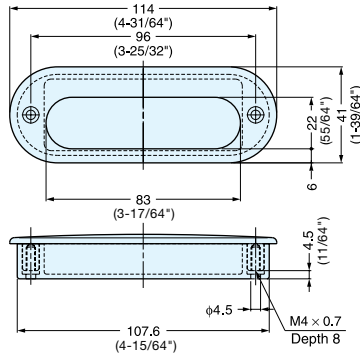

Panel Cut Out Dimensions

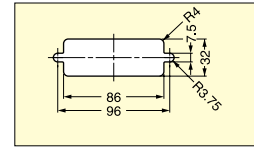

Cut Out Dimensions for sheet metal. Put sheet metal between front and back part for sheet metal applications. (Max. sheet metal thickness: 2 mm)

Item No.	Weight (g)	Box (pcs)	Carton (pcs)
HH-D	85	10	60

Material	Finish/Color
316 Stainless Steel	Mirror
ABS	Black

RECESSED PULL



UT

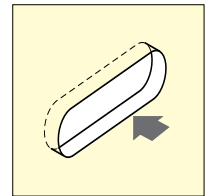
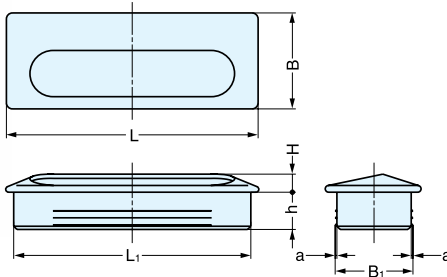

Panel Installation

Material	Finish/Color
304 Stainless Steel	Satin (S)
Brass (UT-105/PB only)	Brass (PB)/(UT-105/PB)
Plastic	Black

Item No.	L	L ₁	H	h	B	B ₁	a	Weight (g)	Box (pcs)	Carton (pcs)
UT-75/S	75 (2-61/64")	71 (2-51/64")	7.0 (9/32")	15.5 (39/64")	36 (1-27/64")	30.8	0.4	15	40	400
UT-105/S-1	105 (4-1/8")	99 (3-57/64")	7.5 (19/64")	15.5 (39/64")	40 (1-37/64")	32.5	0.5	30	25	250
UT-140/S	140 (5-33/64")	134 (5-9/32")	7.5 (19/64")	15.5 (39/64")	47 (1-27/32")	40.5	0.5	45	15	150
UT-105/PB	105 (4-1/8")	99 (3-57/64")	7.5 (19/64")	15.5 (39/64")	40 (1-37/64")	32.5	0.5	30	25	250

RECESSED PULL



SP

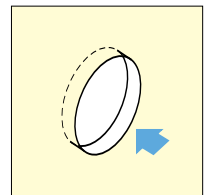
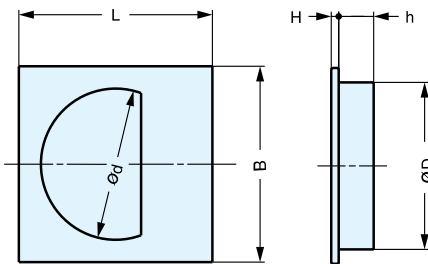

Panel Installation

Material	Finish/Color
304 Stainless Steel	Satin (S)
Brass (SP-35/PB only)	Polished Brass (SP-35/PB)
Plastic	Black

Item No.	L	B	H	h	D	d	Weight (g)	Box (pcs)	Carton (pcs)
SP-35/S	44 (1-47/64")	44 (1-47/64")	2.2	9.8 (25/64")	35.1	31	10	100	1000
SP-38/S	47 (1-27/32")	47 (1-27/32")		10.3 (13/32")	37.6	34	11	60	1440
SP-48/S	57 (2-1/4")	57 (2-1/4")		48.6	44	16	50	1200	
SP-35/PB	44 (1-47/64")	44 (1-47/64")		9.8 (25/64")	35.1	31	10	100	1000