

MULTI-PURPOSE GROMMET AN-SH026-HL Slim Type

SUS

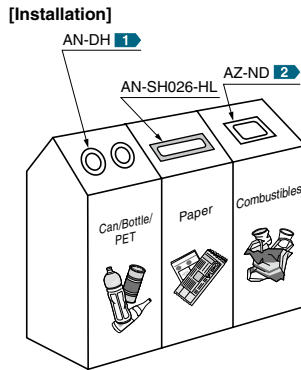

- Corrosion resistant.
- Ideal for magazine/newspaper waste box.

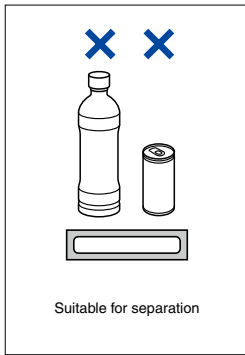
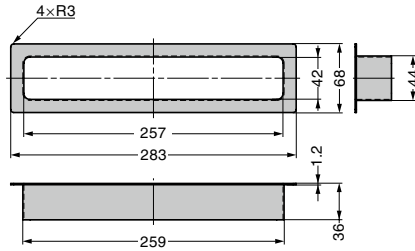

[Cut Out Dimensions]

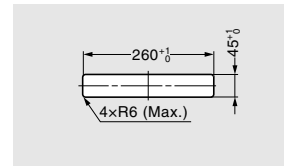

RoHS	CAD	Item Code	Item Name	Old Item Name	Material	Finish	Weight (g)	Box (pcs)	Carton (pcs)
☑	☑	210-028-437	AN-SH026-HL	AN-SH026	Stainless Steel (SUS304)	Satin	290	1	10

Refer to 1 : P.859, 2 : P.865 ※Item name has been revised.

FUNNEL AE-DH

SUS



- For throwing away leftovers like drinks.
- Corrosion resistant.
- Small type AE-DH015 is newly launched.
- Hose 1, strainer 2 are sold separately.

[Sold Separately]

- Hose AE-DH4540-1 1
- Strainer AE-DH020K-45 2

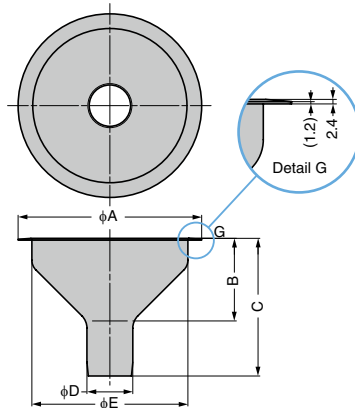
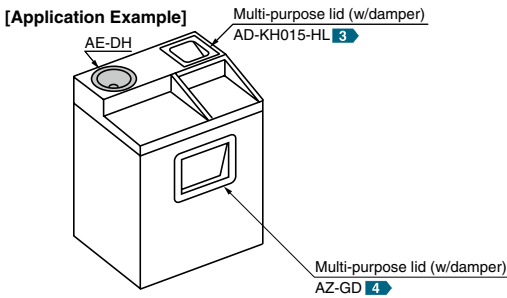

[Cut Out Dimensions]

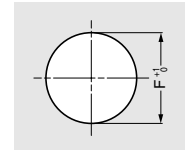

[Easy Installation]

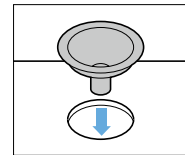

RoHS	CAD	Item Code	Item Name	A	B	C	D	E	F	Material	Finish	Hose Diameter	Weight (g)	Box (pcs)	Carton (pcs)	
☑	☑	210-026-556	AE-DH015-MR	150	55	95	38	120	121	Stainless Steel (SUS304)	Polished	38	270	1	12	
☑	☑	210-026-557	AE-DH015-HL								Satin					1
☑	☑	210-022-106	AE-DH020-MR	200	90	150	50	170	171		Polished	50		490	1	12
☑	☑	210-023-509	AE-DH020-HL								Satin					

Refer to 1 2 : P.867, 3 : P.860, 4 : P.861