

PUSH KNOB BAR LATCH



TLP 3 POINT

CATCHES & LATCHES

PUSH KNOB BAR LATCH



Features

- Recommended for use on large cabinet doors
- By pushing in the latch, easily close all 3 locks at the same time.
- When closed, the push button can be pressed in for a flush appearance
- Has built-in door holding feature to hold door in place when closed without having to use push in knob to lock the door.
- The subsidiary locks are hooking locks and pull the door in to lock.
- Available for both overlay and inset doors. Regardless of type, surface installation is easy.
- Non-handed
- Can be adjusted to different door thicknesses (19-30mm) by adjusting the screws before installing the latch body.
- Post-installation, the push button is fixed in place, preventing rotation for easy use.

Push Knob

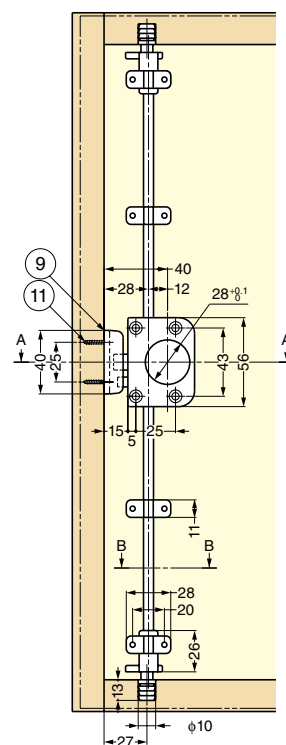
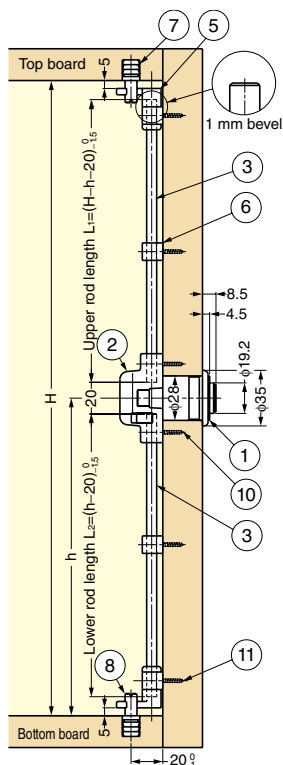
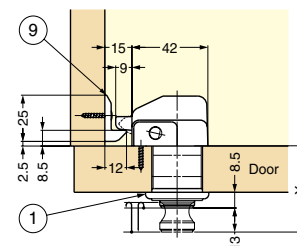
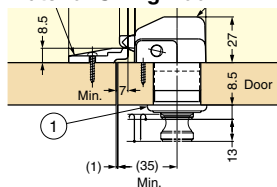
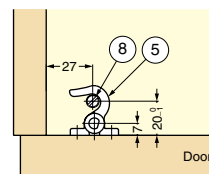

Plate for Swing Door



A-A cross section



B-B cross section

X Dimension

Screw Length	Door Thickness	X
l=24	19	40.5
l=24	20	41.5
l=24	21	42.5
l=24	22	43.5
l=24	23	44.5
l=24	24	45.5
l=24	25	46.5
l=30	26	47.5
l=30	27	48.5
l=30	28	49.5
l=30	29	50.5
l=30	30	51.5

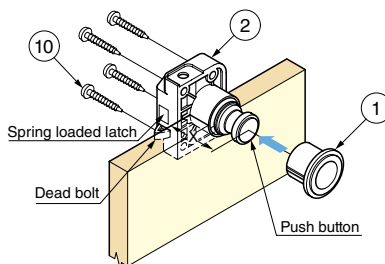

Bore Dimension (Door)

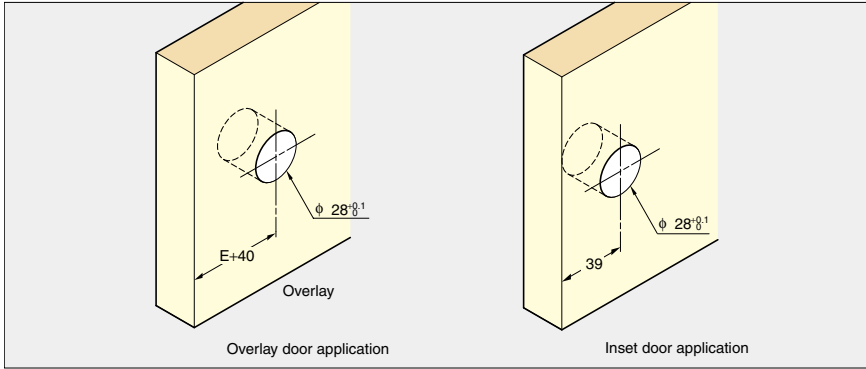

Bore Dimension (Cabinet)

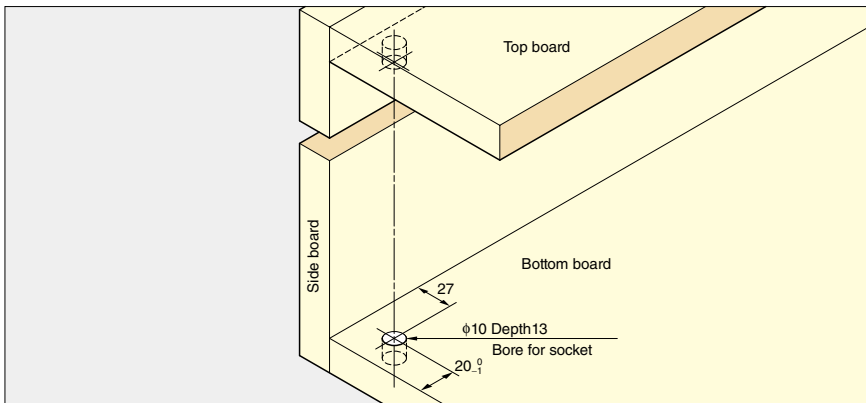

Parts Details

Item Code	Item Name	No.	Name	Door Thickness	Material	Finish/Colour	Needed Qty	Box	Carton
140-060-113	TLP-SG	①	Push Button	19 - 30	Zinc Alloy (ZDC)/Brass	Satin Gold	1 pc	25 pcs	200 pcs
140-064-431	TLP-WB	①	Push Button	19 - 30	Zinc Alloy (ZDC)/Brass	Satin Nickel		25 pcs	200 pcs
140-064-433	TLP-G	①	Push Button	19 - 30	Zinc Alloy (ZDC)/Brass	Gold		25 pcs	200 pcs
140-064-432	TLP-CR	①	Push Button	19 - 30	Zinc Alloy (ZDC)/Brass	Chrome		25 pcs	200 pcs
150-060-240	TLP-W	②	Latch Body	-	Polyamide (PA)	White	1 pc	10 pcs	100 pcs
150-060-231	TLF-1100	③	Prop (Length: 1100)	-	Steel	Nickel	2 pcs	-	50 pcs
150-060-232	TLF-1550	③	Prop (Length: 1550)	-	Steel	Nickel		-	50 pcs
150-060-235	TLF-ST03W	④	Counter Plate for Double Swing Door	-	Polyamide (PA)	White	1 pc	-	-
150-060-271	TLPP-W	⑤ - ⑧, ⑪	Parts Set (White)	-	As below	As below	1 set	25 sets	250 sets
150-060-270	TLPP-BR	⑤ - ⑧, ⑪	Parts Set (Brown)	-	As below	As below		25 sets	250 sets

Parts Included in ②

No.	Part Name	Qty	Material	Finish/Colour
⑨	Counter Plate	1 pc	Polyamide (PA)	White
⑩	Pan Head Tapping Screw 3x20	4 pcs	Steel	Yellow Zinc Chromate
⑪	Pan Head Tapping Screw 3x16	2 pcs	Steel	Yellow Zinc Chromate

Details of ⑤ - ⑧, ⑪

No.	Part Name	Qty	Material	Finish/Colour
⑤	Hook	Left and Right each 1 pc	Polyacetal (POM)	White/Brown
⑥	Holder	4 pcs	Polyamide (PA)	White/Brown
⑦	Socket M6	2 pcs	Polyamide (PA)	White/Brown
⑧	Striker (M6 Screw)	2 pcs	Steel	Nickel
⑪	Pan Head Screw 3x16	8 pcs	Steel	Yellow Zinc Chromate

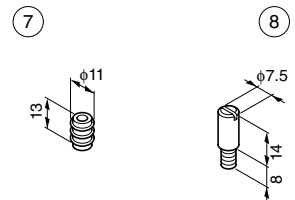
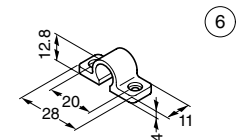
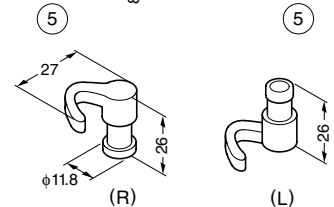
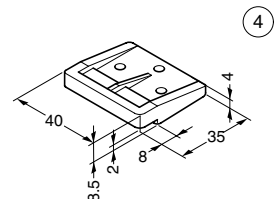
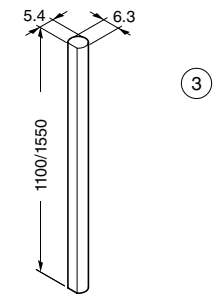
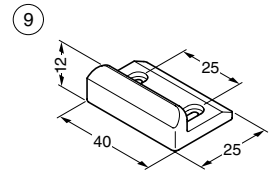
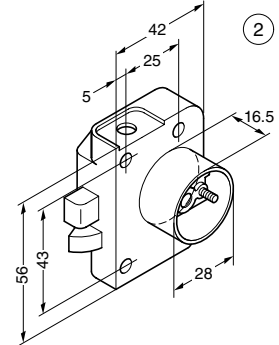
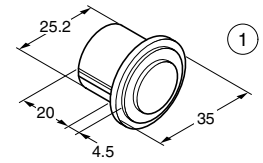

CATCHES & LATCHES

PUSH KNOB BAR LATCH