

# HEAVY DUTY SPRING LOADED LID STAY



S-AT



Side mount type



Back panel mount type

### Features

- Lift assist: makes lids feel lighter and easier to open.
- Free stop: holds position at any angle from 10° - 80°.
- Compact design allows interior to be used effectively.
- Both back mount and side mount type available. Both are non-handed.
- Two different types of strength available.
- Successfully passed 10,000 open/close cycles in a private test.

### Remarks

Do not use with concealed hinges.

### Torque

- With 1 piece  
Torque = 6.1 - 8.8 N·m (62 - 90 kgf·cm)  
... S-AT01(S)
- With 2 pieces, the torque will be doubled.  
Torque = 8.8 - 11.8 N·m (90 - 120 kgf·cm)  
... S-AT02(S)

### Selection Graph

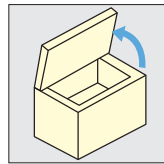
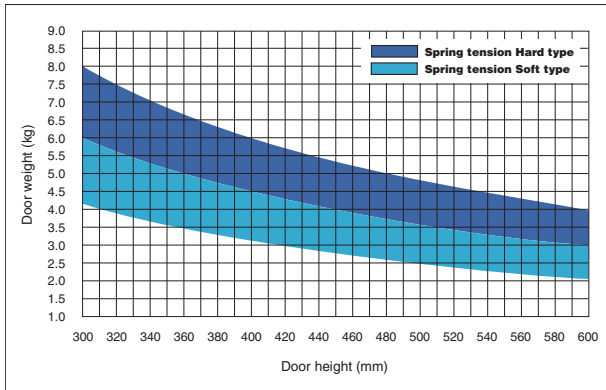

• Easy Operation with Power Assist

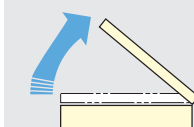

• Free-Stop

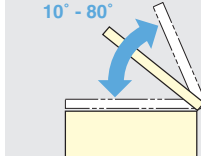

• Compact

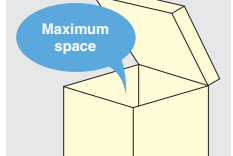

## SIDE MOUNT TYPE



S-AT01, S-AT02

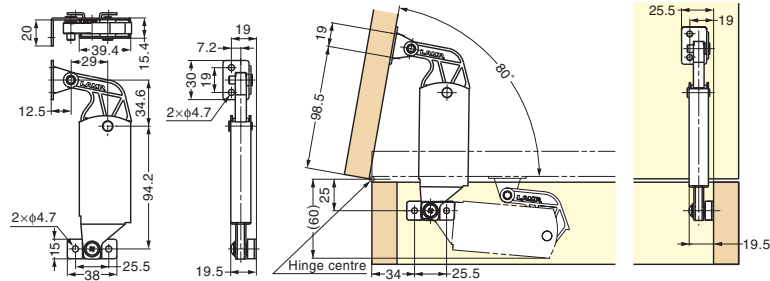

Item Code	Item Name	Material	Finish	Torque Moment	Weight	Box	Carton
180-017-544	S-AT01	Stainless Steel (SUS430)/Polyacetal (POM)	Plain	6.1 - 8.8 N·m/pc	62 - 90 kgf·cm/pc	195 g	10 pcs
180-017-545	S-AT02	Stainless Steel (SUS430)/Polyacetal (POM)	Plain	8.8 - 11.8 N·m/pc	90 - 120 kgf·cm/pc	195 g	10 pcs
180-043-522	S-AT005	Stainless Steel (SUS430)/Polyacetal (POM)	Plain	4.1 - 6.1 N·m/pc	42 - 62 kgf·cm/pc	195 g	10 pcs

## BACK PANEL MOUNT TYPE



S-AT01S, S-AT02S

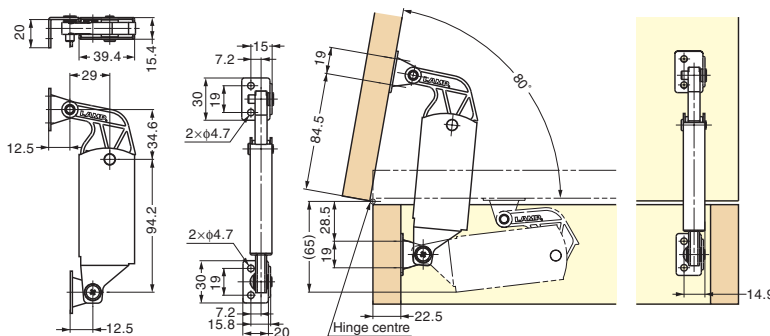

Item Code	Item Name	Material	Finish	Torque Moment	Weight	Box	Carton
180-017-546	S-AT01S	Stainless Steel (SUS430)/Polyacetal (POM)	Plain	6.1 - 8.8 N·m/pc	62 - 90 kgf·cm/pc	195 g	10 pcs
180-017-547	S-AT02S	Stainless Steel (SUS430)/Polyacetal (POM)	Plain	8.8 - 11.8 N·m/pc	90 - 120 kgf·cm/pc	195 g	10 pcs
180-043-523	S-AT005S	Stainless Steel (SUS430)/Polyacetal (POM)	Plain	4.1 - 6.1 N·m/pc	42 - 62 kgf·cm/pc	195 g	10 pcs