

SHELF SUPPORT

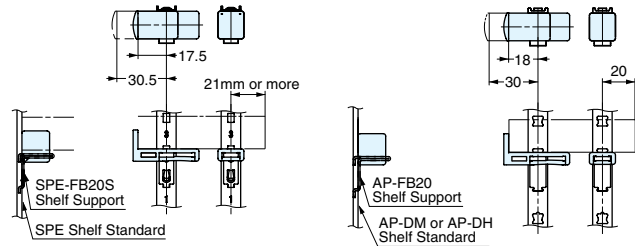

AP-FA20

- Accessory plastic holder used with SPE, AP-DM, and AP-DH series shelf standards (all sold separately) to keep the shelf in position.
- Sold as a set with one front and back shelf holder.

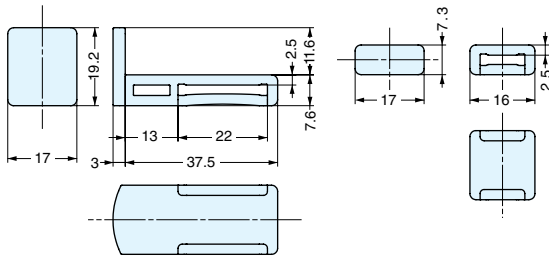
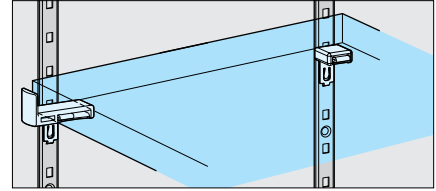
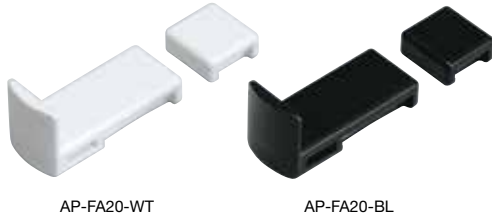

Item No.	Weight (g)	Material	Finish
AP-FA20/WT	4.9	Polyethylene	White
AP-FA20/BL			Black

Item No.	Shelf Thickness	Shelf standard center to front edge distance
AP-FB20	12 mm (15/32")	18.0 - 30.0
SPE-FB20S		17.5 - 30.5
SPE-FB20SWT		17.5 - 30.5

SHELF HOLDER



AP-FK20D

- Accessory clip for use with angled shelves.
- Used with AP-FB series shelf supports along with AP-FK20C core (both sold separately). Both components are compatible with AP-DM or AP-DH series shelf standards.
- Angle shelf 60° downwards.

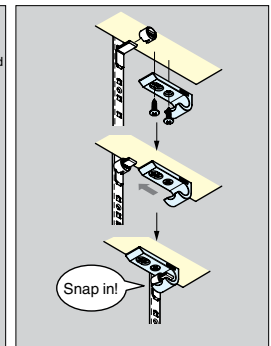
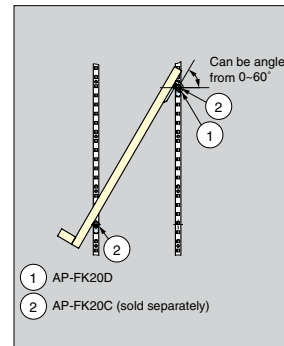
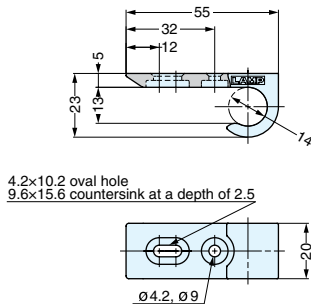

Item No.	Shelf Thickness	Load Capacity	Material	Finish
AP-FK20D	18 mm (Minimum)	294 N/30 kgf	Polyacetal	White