

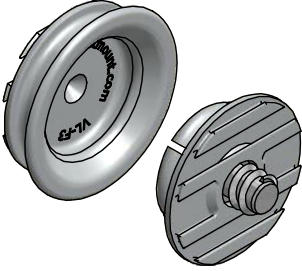

VL-03 Very Low Profile clip set

	<p>USE WITH: When adhesive (glue) fixing Use in accordance with manufacturers instructions, clean surfaces.</p> 	<p>INSTALL WITH: VL-CP centre point</p> 
<p>INSTALLATION STEPS</p>		

1 Exploded view of typical installation (adhesive fix)

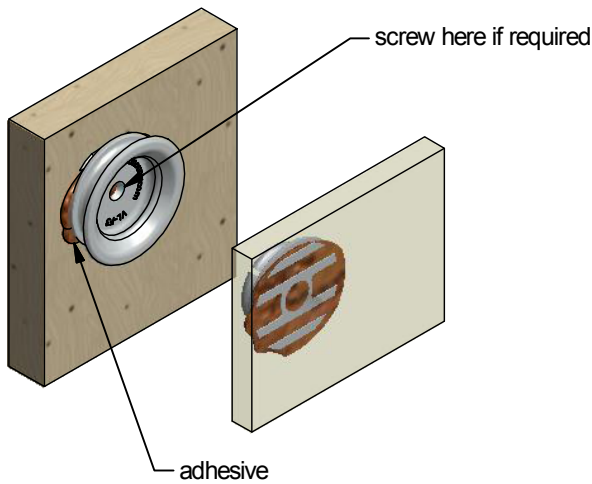

2 Section through installed clip

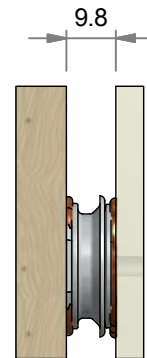

3 Exploded view showing center point marker, install option

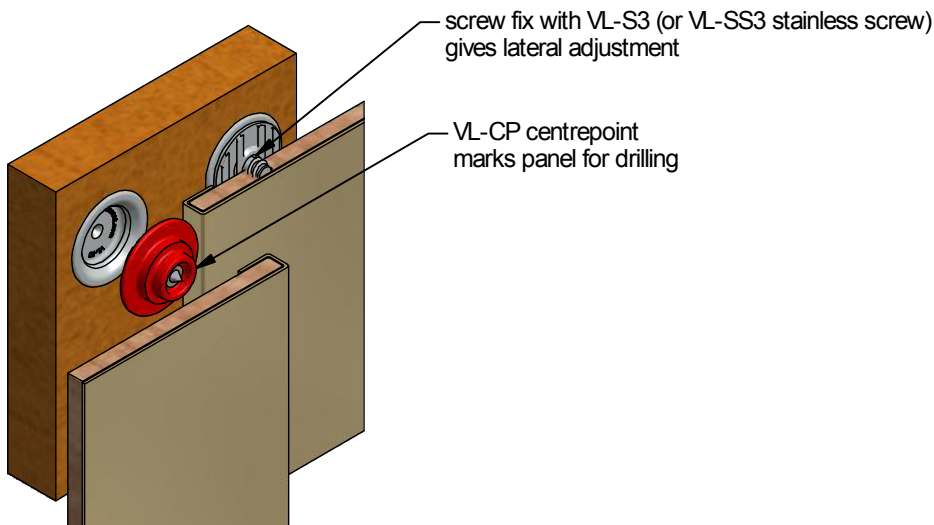

4 Section through recessed installation

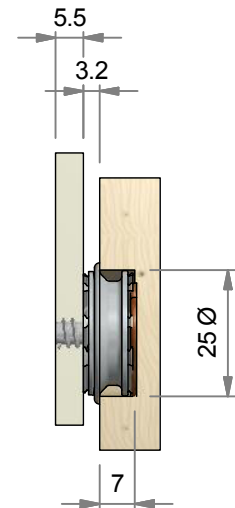

MORE INFO: Setout Guide TD-02 Product sheet VL-03