

BOX LATCH (W/LOCK)



BL-70Y



- Latch ideal for box and case.
- Automatically latches lid when closed.
- Push button to release.
- Includes 2 keys.
- 5 key changes available upon request.

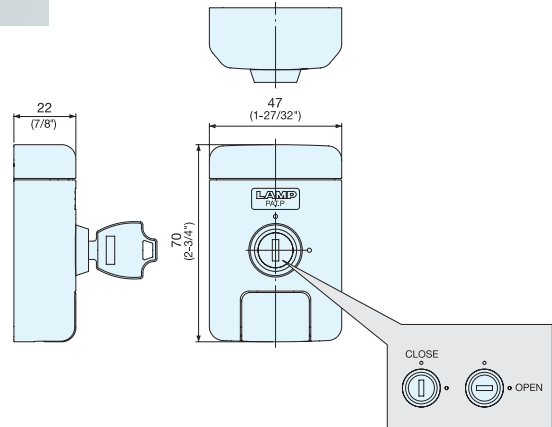
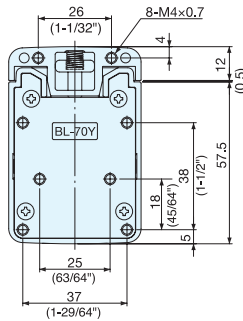
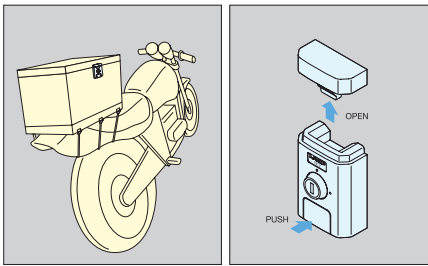

Item No.	Weight (g)	Box (pcs)	Carton (pcs)
BL-70Y	220	5	50

DISCONTINUED

Part Name	Material	Finish/Color
Body, Strike	Zinc Alloy	Silver
Push Button	ABS	Grey

QUICK RELEASE PANEL FASTENER



SX-48



- Snap-in installation.
- Automatically latches when the panel is closed.
- Release multiple latches simultaneously with temporary hold-open feature. (No need to hold finger on latch when releasing).
- Components are plastic and 304 stainless steel to provide high corrosion resistance.
- Nonflammable.

Use multiple latches.

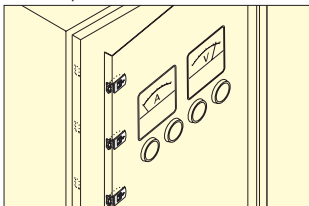

Snap into panel.

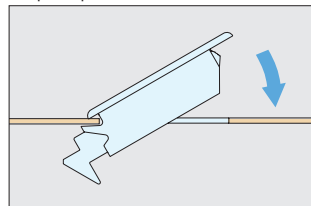

Cut Out Dimensions

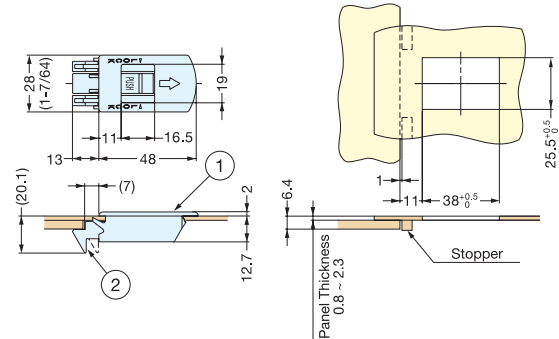

Operation

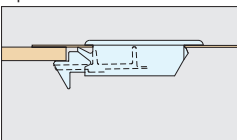

Locks when panel is closed.

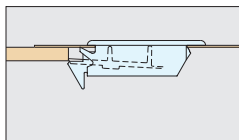

Hold-Open Feature
Each latch will hold in an opened position allowing user to release multiple latches at the same time.

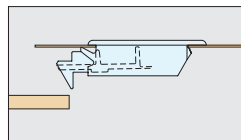

Lever & latch is reset when the panel opens.

Item No.	Panel Thickness (mm)	Retainig Force (kg)	Weight (g)	Box (pcs)	Carton (pcs)
SX-48	0.8~2.3	5 (12 lbs)	11	40	400

No.	Part Name	Material	Finish
①	Case	Polyamide (UL94V-0)	Black
②	Latch	Polyacetal (UL94HB)	
-	Spring	304 Stainless Steel	-