

CABINET LOCK



8810



8810-24

Features

- Brass cylinder lock with stainless steel body.
- Construction Key System - Key number is changeable without replacing cylinder. (Key number can be changed twice.)
- Reversible key can be removed when locked and unlocked. (360° rotation)
- 3 million key changes available (Max. 300 key changes/Master Key).

Remarks

Previous key and key number cannot be used again after changing key number.

Parts Included

- Countersunk head wood screw 3.1 x 25 (for body)
- Countersunk head wood screw 3.1 x 13 (for strike)

Optional Parts

- Master Key (made to order)
- Spacer 6810-SP (P.312)

How to Change Key

- Each lock includes keys for the original key number only.
- To change the lock's key number insert the new key and rotate 360°.
- After changing the lock's key number, the previous used key cannot open the lock.
- 1st and 2nd change keys are sold separately.

Combined Usage with Key and Master Key

- Changing the master keys for each key number is possible.
- Master keys must be also changed after the lock's key number is changed.
- In case only some of the locks' key numbers in Master Key system are changed, master keys for that portion should still be kept.

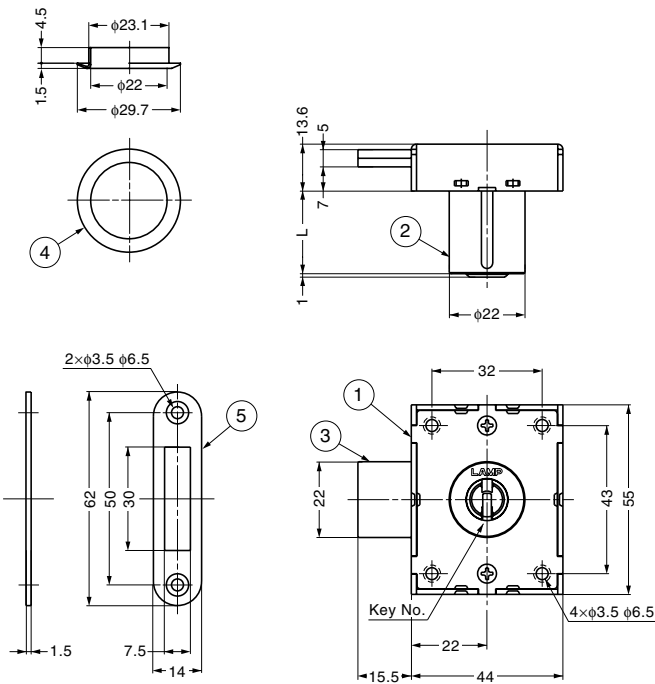

Installation

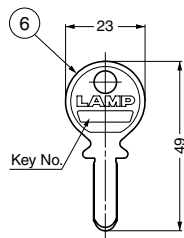
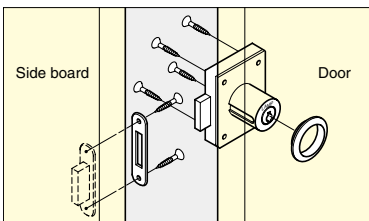

When all keys are changed...

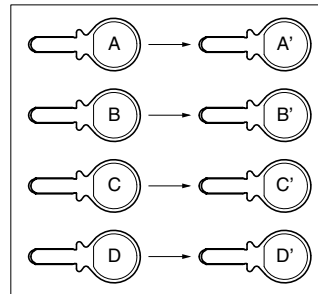

Master Key also needs to be changed.

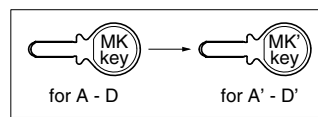

When some keys are changed...

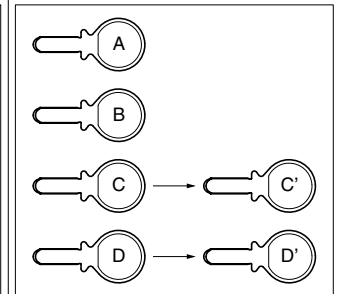

Both the current Master Key and the new Master Key should be kept.

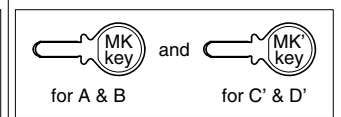

No.	Part Name	Material	Finish/Colour
①	Body	Stainless Steel (SUS304)	Satin
②	Cylinder	Brass	Nickel
③	Dead Bolt	Stainless Steel (SUS304)	-
④	Ring	Brass	Satin Nickel
⑤	Strike	Stainless Steel (SUS304)	Satin
⑥	Key	Nickel Silver	Polished

Item Code	Item Name	Key Type	Master Key System	Cylinder Diameter	Door Thickness	L	Weight	Box	Carton
150-022-338	8810-24MK-B	Key Different	With	φ22	22 - 24	24	190 g	12 pcs	60 pcs
150-022-337	8810-24-B	Key Different	Without	φ22	22 - 24	24	190 g	12 pcs	60 pcs
150-001-221	8810-24-D	Key Alike	Without	φ22	22 - 24	24	190 g	12 pcs	60 pcs
150-029-317	8810-36MK-B	Key Different	With	φ22	34 - 36	36	220 g	12 pcs	60 pcs
150-029-316	8810-36-B	Key Different	Without	φ22	34 - 36	36	220 g	12 pcs	60 pcs
150-001-241	8810-36-D	Key Alike	Without	φ22	34 - 36	36	220 g	12 pcs	60 pcs