

CABINET LOCK 6830-30MK Million Lock Interchangeable Cylinder Series



※Cylinder and key are sold separately.

- Interchangeable cylinder lock series with Master Key system.
- Easy to replace the cylinder by using the Change Key MD-K1.
- Reversible key can be removed when locked and unlocked. (180° rotation).
- 7,800 key changes available. (Max. 750 key changes/Master Key)
- Keys can be shared with interchangeable cylinder lock series. Besides, the Master Key (sold separately) can also be used for unified management.

[Remarks]

- Be sure to read the "Cautions" .
- To remove the cylinder MD-N1 (sold separately), Change Key MD-K1 (sold separately) is required. Change Key MD-K1 also serves as a master key system.

[Parts Included]

- Countersunk head wood screw 2.7 × 13, 3.1 × 22 mm (SUS)

[Sold Separately]

- Cylinder MD-N1
- Master Key MD-MK1, Change Key MD-K1
- Spacer 6810-SP

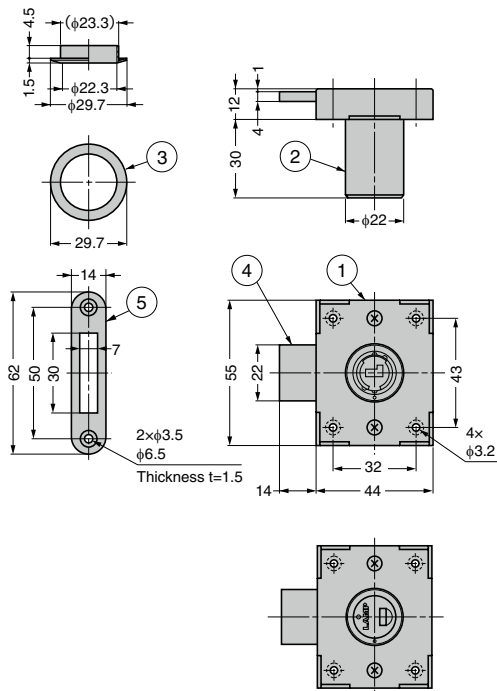

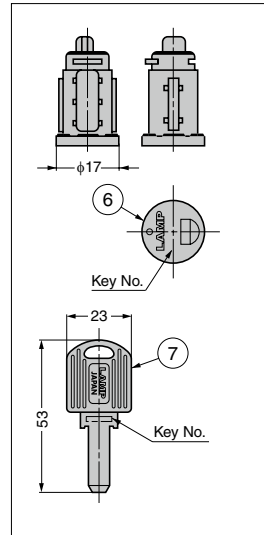

MD-N1 (sold separately) installed

[Cylinder] Sold Separately



Spacer 6810-SP (sold separately)



[Cylinder] Sold Separately

RoHS	CAD	Item Code	Item Name	Key Type	Weight (g)	Box (pcs)	Carton (pcs)
-		150-001-003	MD-N1-B	Key Different	180	-	1
-		150-001-126	MD-N1-D	Key Alike	180	-	1

[Master Key/Change Key] Sold Separately





RoHS	CAD	Item Code	Item Name	Type	Weight (g)	Box (pcs)	Carton (pcs)
-		150-001-002	MD-MK1	Master Key	12	-	1
-		150-001-001	MD-K1	Change Key	16	-	1

[Spacer] Sold Separately

RoHS	CAD	Item Code	Item Name	Weight (g)	Box (pcs)	Carton (pcs)
		150-060-206	6810-SP	4	150	1500

No.	Part Name	Material	Finish/Colour
①	Body	Stainless Steel (SUS304)	Satin
②	Housing	Zinc Alloy (ZDC)	GA: Gold, Paint/Clear DN: Satin Nickel
③	Ring	Brass	DN: Satin Nickel
④	Dead Bolt	Stainless Steel	-
⑤	Strike	(SUS304)	Satin
⑥	Cylinder (Sold Separately)	Stainless Steel (SUS304)/ Zinc Alloy (ZDC)	Barrel Polished/ Coloured Zinc Chromate
⑦	Key (Sold Separately)	Brass/ABS	Nickel/Black

[Body]

RoHS	CAD	Item Code	Item Name	Finish	Cylinder Diameter	Door Thickness	Weight (g)	Box (pcs)	Carton (pcs)
		150-060-196	6830-30MKGA	Gold, Paint/Clear	22	30	180	12	60
		150-060-193	6830-30MKDN	Satin Nickel				12	60

Refer to  :P.718

CAM
LOCKS

DIAL
LOCKS

GLASS
DOOR
LOCKS

CABINET
DOOR
LOCKS

OTHER
LOCKS