

LAMP® SOFT-CLOSE FOLDING DOOR SYSTEM



Door Width	380-460mm
Door Height	Max. 2600mm
Door Thickness	18-30mm
Door Weight	Max. 8kg (Per door) *1
Door Type	Bi-Folding Doors (Overlay)

\*1 Please prioritize door weight when selecting doors.

No guide rail on top or bottom, outfitted with soft-close mechanism.

Features

- When door is within a certain range, the door will automatically close itself due to its built-in mechanism.
- No rail on top or bottom makes installation easy.
- Door can be adjusted after installation because of concealed hinges.

Remarks

- For the top and bottom concealed hinges, please place them 100mm from the edge. (Place the middle hinge equidistance from the others)
- The bi-fold door hinge should be evenly placed depending on the doors height.
- If you are using a hinge besides the H230, please contact our sales department for more information.

WARDROBE & CABINET DOOR HARDWARE



Body

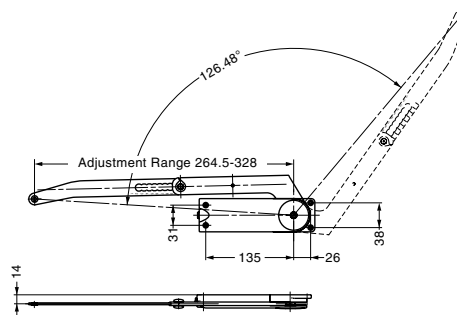

Dimension

The circled numbers are referenced on the next page.

The picture below shows a right opening door. A left opening door would be the opposite set up.

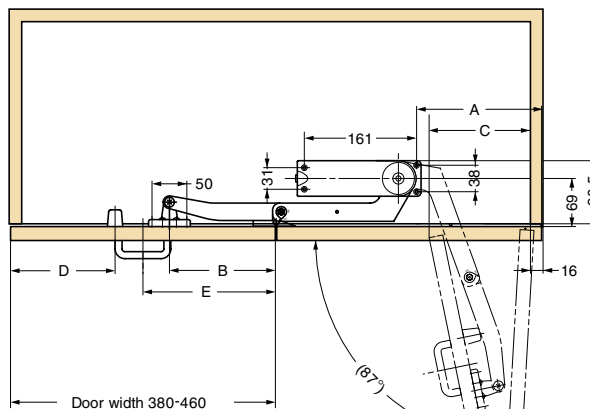
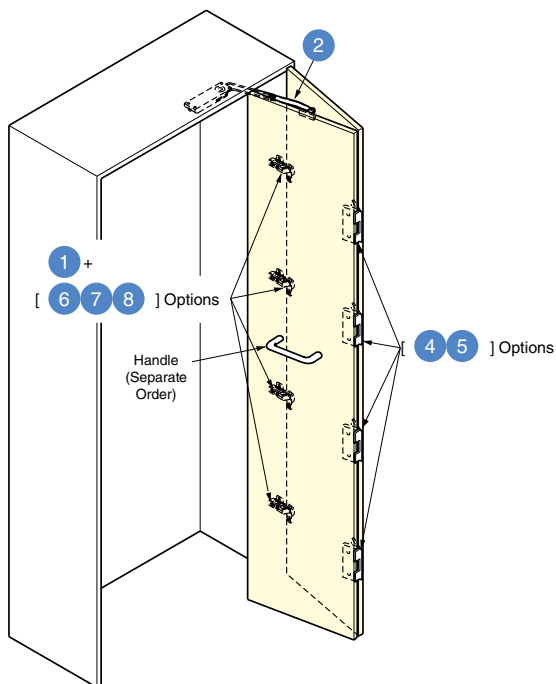

The picture features SFD-3L-R (right opening type).

The installation above is for a half overlay hinge.

The above installation can be used for a full overlay hinge.

For use with an inset hinge, please contact us directly for more information.

\*2 Install the handle between the bi-fold door hinge and the position specified in column E (below)

Door Width	Available Range	Adjustable Position	A	B	C	D	E
380	375-385	1	179.5	152	(145)	(150)	(190)
390	385-395	2	184.5	155	(150)	(155)	(195)
400	395-405	3	189.5	158	(154)	(160)	(200)
410	405-415	4	194.5	161	(158)	(165)	(205)
420	415-425	5	199.5	164	(162)	(170)	(210)
430	425-435	6	204.5	167	(168)	(170)	(215)
440	435-445	7	209.5	170	(172)	(175)	(220)
450	445-455	8	214.5	173	(177)	(180)	(225)
460	455-465	9	219.5	176	(181)	(180)	(230)

FOLDING DOOR SYSTEM

Door Movement

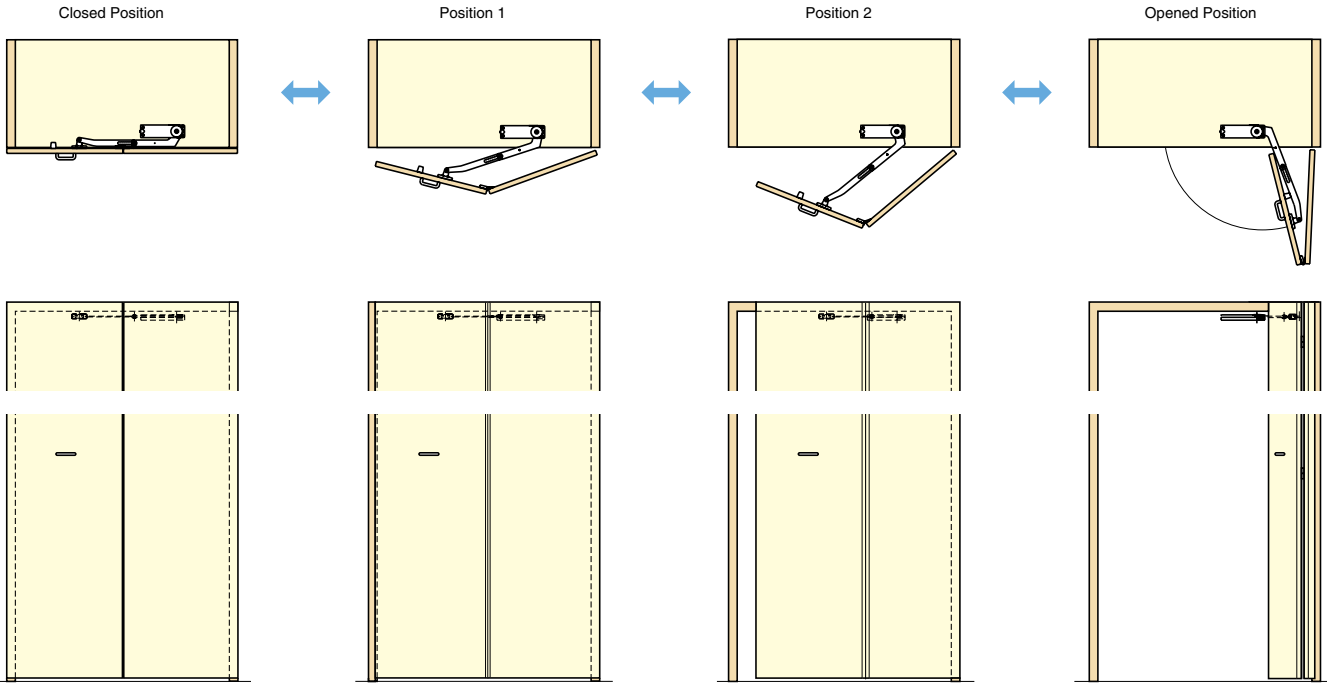

How to order the Soft-Close Folding Door System SFD

• When ordering..... Mounting Plate + Body / Bi-Fold Door Hinge / Hinge

WARDROBE & CABINET DOOR HARDWARE

FOLDING DOOR SYSTEM

Mounting Plate



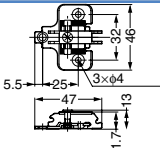





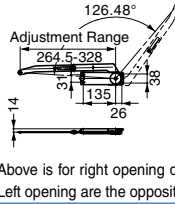

Required for every order. Please refer to the table below for number of hinges required.

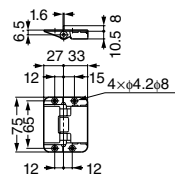
No.	Item Code	Part	Dimensions	Finish
1	160-070-041 [Item Name] 230-P4W-32T	Mounting Plate 		• Material: Steel • Finish: Nickel

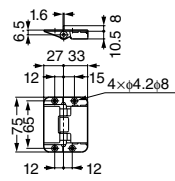
Body - Bi-Fold Door Hinge - Hinge

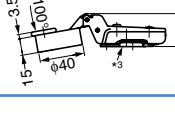
Please read the following and confirm which parts are necessary for installation.

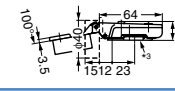
Select 2 or 3 based on the opening direction of the door. Choose between 4 and 5 bi-fold door hinges. Choose between 6, 7 and 8 concealed hinges depending on inset or overlay. Use the list on the bottom left hand of this page to find the number of hinges required for installation.

No.	Type	Item Code	Parts	Dimension	Finish
2	Right Open Type	250-100-391 [Item Name] SFD-3L-R	Body 		• Main materials: ABS Resin Steel • Finish/Color: Nickel Light Gray
3	Left Open Type	250-100-390 [Item Name] SFD-3L-L		Above is for right opening door. Left opening are the opposite.	
4	Nickel	250-129-208 [Item Name] CH-75NI	Bi-Fold Door Hinge 		• Material: Body: ZDC Plastic: Polyamide(PA) / Polyacetyl • Finish: Body: Nickel Plastic: Brown
5	Bronze	250-120-031 [Item Name] CH-75GB			• Material: Body: ZDC Plastic: Polyamide(PA) / Polyacetyl • Finish: Body: Bronze Plastic: Brown
6	Overlay	160-079-414 [Item Name] H230-26/16T	Concealed Hinge 		• Material: Steel • Finish: Nickel
7		160-079-413 [Item Name] H230-26/26T	Concealed Hinge 		
8	Inset	160-079-415 [Item Name] H230-26/OT	Concealed Hinge 		

Required number of concealed hinges 6, 7, 8, and bi-fold door hinges 4, 5 for installation.

Door Height	Bi-Fold Door Hinge 4, 5	Hinge 6, 7, 8	Mounting Plate 1
500mm or less	2 pcs.	2 pcs.	2 pcs.
500-1000mm	2 pcs.	3 pcs.	3 pcs.
1000-1500mm	3 pcs.	4 pcs.	4 pcs.
1500-2000mm	4 pcs.	5 pcs.	5 pcs.
2000-2600mm	4 pcs.	6 pcs.	6 pcs.

\*3 This illustration is of an attached hinge.