

LATERAL OPENING DOOR SYSTEM

FAD-54 / FAD-54L

SLIDING & FOLDING DOOR HARDWARE



Handle on picture sold separately. (Item No. : XLA-HH series)

MonoFlat FAD™

| Item No. | FAD-54 | FAD-54L |
|----------------|--------------------------------|--------------------------|
| Door Width | 800-850 mm (31-1/2"-33-15/32") | |
| Door Height | Max. 2380 mm (93-11/16") | Max. 2980 mm (117-5/16") |
| Door Thickness | 24-38 mm (61/64"~1-1/2") | |
| Door Weight | Max. 35 kg (77 lbs)/Door | |

*In case of 25mm (1") overlay.

- Other "MonoFlat series" available.
 - MonoFlat FAD-5 For door weight 5 kg (11 lbs) – P.599
 - MonoFlat FAD-20 For door weight 20 kg (44 lbs) – P.600~601
 - MonoFlat LIN-X For door weight 24 kg (53 lbs) – P.592~597
 - MonoFlat Unison For door weight 30 kg (66 lbs) – P.558~559

LATERAL OPENING DOOR SYSTEM

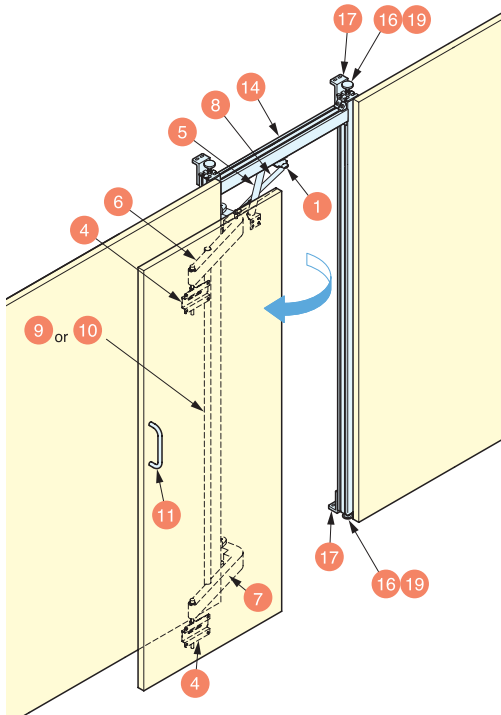

- Flush Surface
Designed to close flush against surrounding walls, providing clean appearance.
- Lateral Opening Mechanism
Allows doors to swing out laterally in a small radius, ideal for tight front space application.
- Aluminum frame supplied for durable construction
- No rails or bottom guide required
- Smooth Movement
Built-in gas spring provides a smooth self opening & closing movement.
- Height adjustable by cutting arm connecting pipe
- Various applications
Can be used in single or double door configuration. Ideal for walk-in closets, partitions, hidden door applications etc.

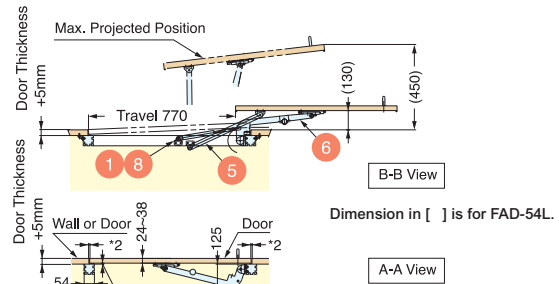

Dimension in [] is for FAD-54L.

Various Opening Configurations

Left Hand Use



Right / Left Combinations



Right Hand Use

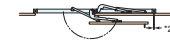

*1 Vertical frame or door stoppers on floor for both doors required in center.



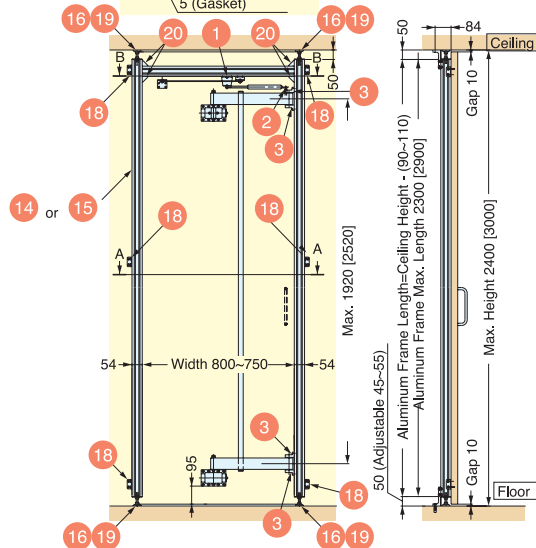
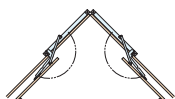

Corner Use





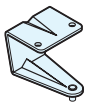

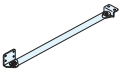
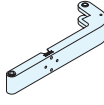
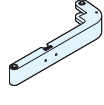
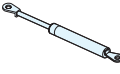
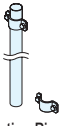
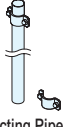

*2 Min.4mm gap on both side of door.

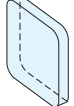
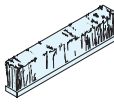
| Parts Set (per door) | | Necessary Parts | |
|----------------------|--------------------------|----------------------------------|--|
| Item No. | Door Height | Description | |
| FAD-54 | Max. 2380 mm (93-11/16") | Please see Qty a | |
| FAD-54L | Max. 2980 mm (117-5/16") | Please see Qty b | |

Parts Included

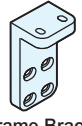
| No. | Qty | | Part Name | Description |
|-----|------|------|--|--|
| | a | b | | |
| 1 | 1pc | 1pc |  Gas Spring Bracket | <ul style="list-style-type: none"> Material/Steel Finish/Clear Zinc Chromate |
| 2 | 1pc | 1pc |  Screw Pin | <ul style="list-style-type: none"> Material/Steel Finish/Clear Zinc Chromate |
| 3 | 4pcs | 4pcs |  Bearing Housing | <ul style="list-style-type: none"> Material/Aluminum Finish/Color - Silver |
| 4 | 2pcs | 2pcs |  Arm Bracket | <ul style="list-style-type: none"> Material/Steel, Polyacetal Finish/Color - Silver |
| 5 | 1pc | 1pc |  Support Arm | <ul style="list-style-type: none"> Material/Steel, Polyacetal Finish/Color - Silver |
| 6 | 1pc | 1pc |  Upper Arm | <ul style="list-style-type: none"> Material/Aluminum Finish/Color - Silver |
| 7 | 1pc | 1pc |  Bottom Arm | <ul style="list-style-type: none"> Material/Aluminum Finish/Color - Silver |
| 8 | 1pc | 1pc |  Gas Spring | <ul style="list-style-type: none"> Color/Grey |
| 9 | 1set | - |  Connecting Pipe & Clamp | <ul style="list-style-type: none"> Material/Steel Finish/Color - Silver 1990 mm |
| 10 | - | 1set |  Connecting Pipe & Clamp | <ul style="list-style-type: none"> Material/Steel Finish/Color - Silver 2600 mm |

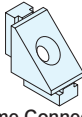
| No. | Qty | | Part Name | Description |
|-----|-----------|-----------|---|--|
| | a | b | | |
| 11 | 1pc | 1pc |  Handle | <ul style="list-style-type: none"> Material / 304 Stainless Steel Finish / Mirror |
| 12 | 1pc | 1pc |  Bumper | <ul style="list-style-type: none"> Material/Polyurethane Finish/Clear |
| 13 | 1pc | 1pc |  Strip Brush | <ul style="list-style-type: none"> Color/Grey |
| 14 | V 2pcs | - |  Alum. Frame (FAD-54) (V2300mm, H800mm) | <ul style="list-style-type: none"> Material/Aluminum Finish/Anodized |
| 15 | - | V 2pcs |  Alum. Frame (FAD-54L) (V2900mm, H800mm) | <ul style="list-style-type: none"> Material/Aluminum Finish/Anodized |
| 16 | 4pcs | 4pcs |  Glide Base | <ul style="list-style-type: none"> Material/Steel Finish/Color - Silver |
| 17 | 4pcs | 4pcs |  Frame Bracket | <ul style="list-style-type: none"> Material/Aluminum Finish/Color - Silver |
| 18 | 6pcs | 6pcs |  Angle Connector | <ul style="list-style-type: none"> Material/Steel Finish/Clear Zinc Chromate |
| 19 | 4pcs | 4pcs |  Leveling Glide | <ul style="list-style-type: none"> Material/Steel, Elastomer Finish/Color <ul style="list-style-type: none"> - Clear Zinc - Chromate - Black |
| 20 | 8pcs | 8pcs |  Frame Connector | <ul style="list-style-type: none"> Material/Aluminum, Zinc Alloy Finish/Silver, Chromate |