

LOCK FOR DOUBLE SWINGING GLASS DOOR

XL-GC01



Features

- Non-handed. Key hole located on the right side for clean appearance and high security.
- Key works as a knob in unlocked position.
- 24 key changes available.

Remarks

Use with XL-GC09-CR (P.274) for inset doors.

Parts Included

- Gasket
- Transparent bumper

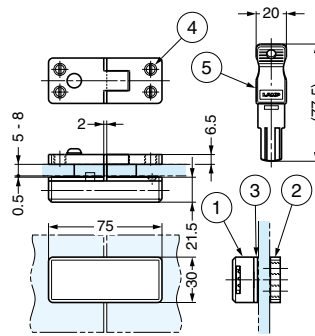

Cut Out Dimensions

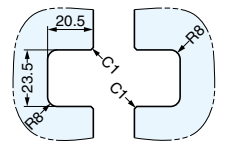

Installation

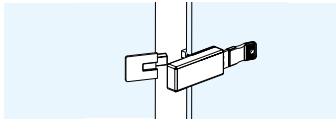

No	Part Name	Material	Finish/Colour
①	Body	Zinc Alloy (ZDC)	Chrome
②	Strike	Zinc Alloy (ZDC)	Chrome
③	Spacer	Vinyl Chloride Resin (PVC)	Clear
④	Fixing Screw	Stainless Steel (SUS304)	Plain
⑤	Key	Brass/ABS	Nickel/Black

Item Code	Item Name	Key Type	Glass Thickness	Weight	Carton
150-061-100	XL-GC01-CR-B	Key Different	5, 6, 8	400 g	24 pcs
150-001-052	XL-GC01-CR-D	Key Alike	5, 6, 8	400 g	24 pcs

LOCK FOR INSET SWINGING GLASS DOOR



XL-GC02



Features

- Non-handed. Key hole located on the right side for clean appearance and high security.
- 24 key changes available.

Parts Included

- Gasket
- Countersunk head wood screw 3.1 x 20 (SUS)

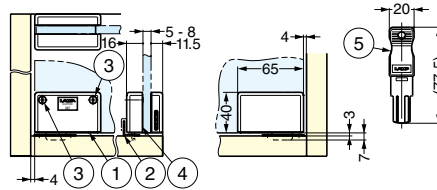

Cut Out Dimensions

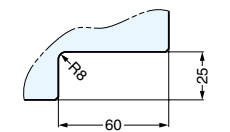

Left

No	Part Name	Material	Finish/Colour
①	Body	Zinc Alloy (ZDC)	Chrome
②	Strike	Stainless Steel (SUS304)/Chloroprene Rubber (CR)	Gloss Barrel/Black
③	Fixing Screw	Stainless Steel (SUS304)	Plain
④	Spacer	Rubber	Black
⑤	Key	Brass/ABS	Nickel/Black

Item Code	Item Name	Key Type	Type	Glass Thickness	Weight	Carton
150-061-102	XL-GC02-R-CR-B	Key Different	Right	5, 6, 8	411 g	24 pcs
150-001-054	XL-GC02-R-CR-D	Key Alike	Right	5, 6, 8	411 g	24 pcs
150-061-101	XL-GC02-L-CR-B	Key Different	Left	5, 6, 8	411 g	24 pcs
150-001-053	XL-GC02-L-CR-D	Key Alike	Left	5, 6, 8	411 g	24 pcs

LOCK FOR SLIDING GLASS DOOR

XL-GC03



Features

- Non-handed. Key hole located on the right side for clean appearance and high security.
- 24 key changes available.

Remarks

Please order 1 pc for 2 doors.

Optional Parts

XL-GC03-GL1200 (P.641)

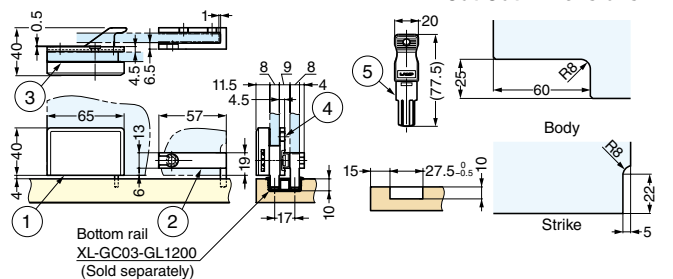

Cut Out Dimensions

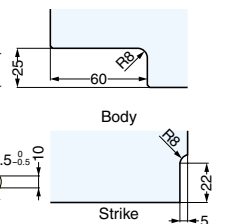

No	Part Name	Material	Finish/Colour
①	Body	Zinc Alloy (ZDC)	Chrome
②	Strike	Zinc Alloy (ZDC)	Chrome
③	Spacer	Rubber	Black
④	Fixing Screw	Stainless Steel (SUS304)	Plain
⑤	Key	Brass/ABS	Nickel/Black

Item Code	Item Name	Key Type	Glass Thickness	Weight	Carton
150-061-103	XL-GC03-CR-B	Key Different	8	371 g	24 pcs
150-001-055	XL-GC03-CR-D	Key Alike	8	371 g	24 pcs

