









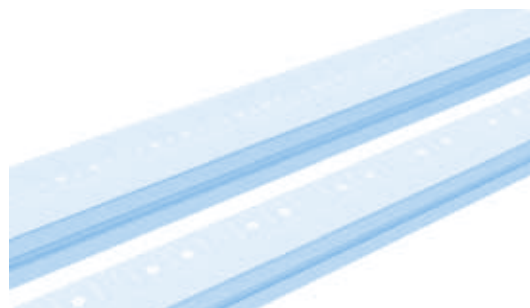
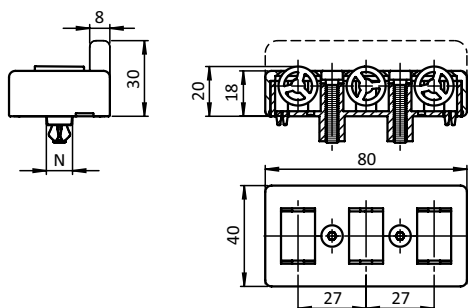

ROLLENELEMENT, SCHRAUBBAR

ROLLER ELEMENT, SCREW-ON VERSION

Ausführung	ohne Nut, Nut 8, Nut 10	Model	Without slot, slot 8, slot 10
Beschreibung	zur Herstellung von Rollenbahnen in beliebiger Breite und Länge, inkl. 2 Schrauben M5 × 25	Description	For manufacturing roller conveyors in any width and length, incl. 2 Screws M5 × 25
Material	Gehäuse: Kunststoff PA, glaskugelverstärkt Rollen: Kunststoff POM Montageset: Stahl	Material	Casing: Plastic PA, glass ball reinforced Rollers: Plastic POM Assembly set: Steel
Farbe	schwarz	Color	Black
Befestigung	Variante 1 (mit Klemmhammer): durch Einschrauben oder Einschlagen von 2 Schrauben M5 × 25 Variante 2 (ohne Klemmhammer): mit 2 Schrauben M5 × 25 und Nutensteinen oder Hammermuttern	Fastening	Version 1 (with clamp hammer): to be fastened with 2 screw-in or knock-in screws M5 × 25 Version 2 (without clamp hammer): using 2 screws M5 × 25 and T-slot nuts or hammer nuts
Montageset 2	2 Hammermuttern Nut 10 - M5	Assembly Set 2	2 hammer nuts lot 10 - M5
Liefereinheit	10 Stück	Pack Quantity	10 pieces
Hinweis	*  elektrostatisch entladende Ausführung wird ohne Klemmhammer geliefert, zur Montage mit  elektrostatisch entladenden Hammermuttern oder Nutensteinen	Tip	*  delivery of electrostatically discharging version without clamp hammer, to fasten with  electrostatically discharging hammer nuts or T-slot nuts



Rollenelement, schraubbar <i>Roller Element, Screw-on Version</i>	Montageset	N	ESD	Gewicht [g] <i>Weight [g]</i>	Profil <i>Profile</i>	Teil-Nr. <i>Part #</i>
ohne Seitenführung <i>Without lateral guide</i>		- / 8 / 10		53.0		09309302
		- / 8 / 10		54.5		* 09309302S01
	inkl. Montageset 1 <i>With assembly set 1</i>	8		62.0	I	* 09309302S03
	inkl. Montageset 2 <i>With assembly set 2</i>	10		70.0	B	* 09309302S02
mit Seitenführung <i>With lateral guide</i>		- / 8 / 10		59.0		09309304
		- / 8 / 10		61.5		* 09309304S01
	inkl. Montageset 1 <i>With assembly set 1</i>	8		69.0	I	* 09309304S04
	inkl. Montageset 2 <i>With assembly set 2</i>	10		77.0	B	* 09309304S03