

Series 94 and 95 stainless steel mini-cylinders

Single-acting and double-acting, magnetic

Series 94: \varnothing 16, 20, 25 mm

Series 95: \varnothing 25 mm, cushioned



- » In compliance with Cetop RP52-P and DIN/ISO 6432 standards
- » Clean design
- » Stainless steel AISI 304 and AISI 316

Series 94 and 95 cylinders are suitable for use in the off-shore, naval, pharmaceutical, nuclear and food industries.

Their construction enables the replacement of all seals. Series 95 is normally equipped with adjustable end-stroke cushioning by means of a screw on the end block. In addition both Series 94 and 95 are equipped with a mechanical cushioning in order to make the impact of the piston less noisy as it reaches the end of the stroke.

GENERAL DATA

Construction	end blocks secured to the tube
Operation	single-acting and double-acting
Materials	end blocks and rod in stainless steel AISI 316, seals in NBR, plastic guiding element, NSF H1-certified lubricant Series 94: tube in stainless steel AISI 304 Series 95: tube in stainless steel AISI 316
Mounting	several types of cylinders clamps available
Strokes min - max	10 ÷ 500 mm
Operating temperature	0° - 80°C (with dry air -20°C)
Operating pressure	1 ÷ 10 bar
Speed	10 ÷ 1000 mm/sec (without load)
Fluid	clean air, without lubrication. If lubricated air is used, it is recommended to use oil ISOVG32. Once applied the lubrication should never be interrupted.

STANDARD STROKES FOR MINICYLINDERS SERIES 94 AND 95

- = single-acting
- ✕ = double-acting

STANDARD STROKES		10	25	40	50	80	100	125	160	200	250	300	320	400	500
94	16	✕✕	✕✕	✕✕	✕✕	✕	✕	✕	✕	✕					
94	20	✕✕	✕✕	✕✕	✕✕	✕	✕	✕	✕	✕	✕	✕			
94	25	✕✕	✕✕	✕✕	✕✕	✕	✕	✕	✕	✕	✕	✕	✕	✕	✕
95	25	✕	✕	✕	✕	✕	✕	✕	✕	✕	✕	✕	✕	✕	✕

CODING EXAMPLE

94	N	2	A	16	A	100	
94	SERIES 94 = magnetic 95 = magnetic, cushioned					PNEUMATIC SYMBOLS CS06 (S. 94) CD08 (S. 94) - CD09 (S. 95) CD12 (S. 94) - CD13 (S. 95)	
N	VERSION N = standard						
2	OPERATION 1 = single-acting, front spring 2 = double-acting 3 = double-acting, through-rod						
A	MATERIALS A = stainless steel, seals in NBR V = stainless steel, all seals in FKM (150°C)						
16	BORE 16 = 16 mm - 20 = 20 mm - 25 = 25 mm						
A	TYPE OF DESIGN A = standard with locking ring for end cap Mod. V and piston rod lock nut Mod. U						
100	STROKE (see the table)						
	= standard V = rod seal in FKM						

PNEUMATIC SYMBOLS

The pneumatic symbols which have been indicated in the CODING EXAMPLE are shown below.

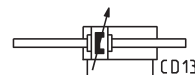
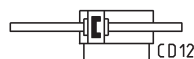
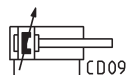
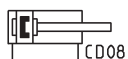

ACCESSORIES FOR STAINLESS STEEL MINICYLINDERS SERIES 94 AND 95



Foot mount Mod. B



Flange bracket Mod. E

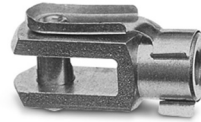

Trunnion bracket Mod. I

 Rod fork end
Mod. G-94/90

 Swivel ball joint
Mod. GA-94/90

 Piston rod lock nut
Mod. U-94/90

 Nose nut Mod. V-94 and
Mod. U-90



All accessories are supplied separately, except for piston rod lock nut Mod. U

Cylinders Series 94 and 95

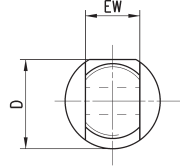
With threaded front and rear end blocks

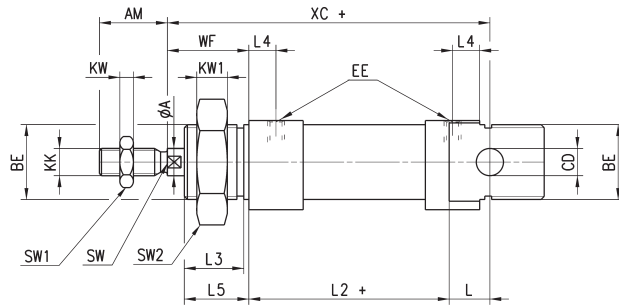

+ = add the stroke



DIMENSIONS

Mod.	∅	A	AM	BE	CD	D	EE	EW	KK	KW	KW1	L	L2	L3	L4	L5	SW	SW1	SW2	WF	XC
94	16	6	16	M16x1.5	6	21.2	M5	12	M6	4	5	9	51	14	5.5	15	5	10	24	22	82
94	20	8	20	M22x1.5	8	26.2	G1/8	16	M8	5	5	12	59	17.5	8	19	7	13	32	24	95
94-95	25	10	22	M22x1.5	8	32.5	G1/8	16	M10x1.25	6	5	12	64	18.5	7.5	20	8	17	32	28	104

Cylinders Series 94 and 95 - through-rod

With threaded end blocks

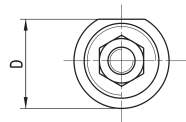

+ = add the stroke once
++ = add the stroke twice

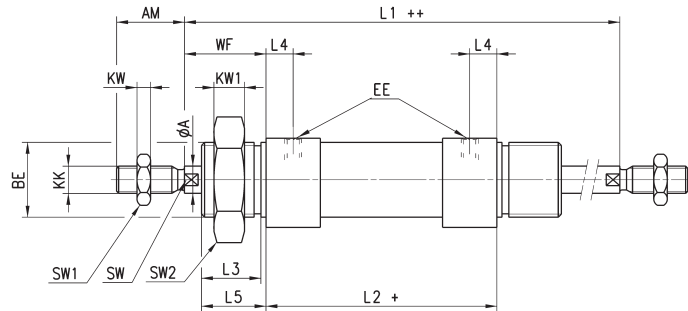

DIMENSIONS

Mod.	∅	A	AM	BE	D	EE	KK	KW	KW1	L1	L2	L3	L4	L5	SW	SW1	SW2	WF
94	16	6	16	M16x1.5	21.2	M5	M6	4	5	100	56	14	5.5	15	5	10	24	22
94	20	8	20	M22x1.5	26.2	G1/8	M8	5	5	116	68	17.5	8	19	7	13	32	24
94-95	25	10	22	M22x1.5	32.5	G1/8	M10x1.25	6	5	125	69	18.5	7.5	20	8	17	32	28

Foot mount Mod. B

Material: stainless steel 304

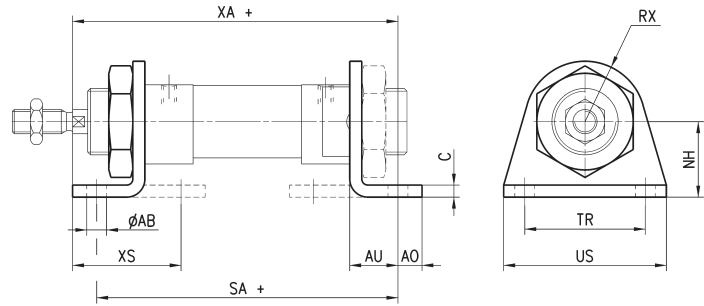
 Supplied with:
 2x feet
 1x nut

+ = add the stroke

DIMENSIONS

Mod.	Ø	ØAB	XS	XA+	SA+	AO	AU	C	RX	TR	US	NH
B-94-12-16	16	5,5	32	91	82	6	13	3	13	32	42	20
B-94-20-25	20	6,6	36	108	100	8	16	4	20	40	54	25
B-94-20-25	25	6,6	40	113	101	8	16	4	20	40	54	25

Flange bracket Mod. E

Material: stainless steel 304

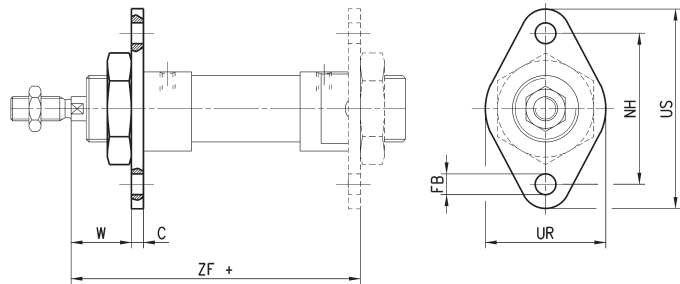
 Supplied with:
 1x flange

+ = add the stroke

DIMENSIONS

Mod.	Ø	W	C	ZF+	FB	UR	TF	UF
E-94-12-16	16	19	3	81	5,5	30	40	53
E-94-20-25	20	20	4	96	6,6	40	50	66
E-94-20-25	25	24	4	101	6,6	40	50	66

Trunnion Bracket Mod. I

Material: stainless steel 304

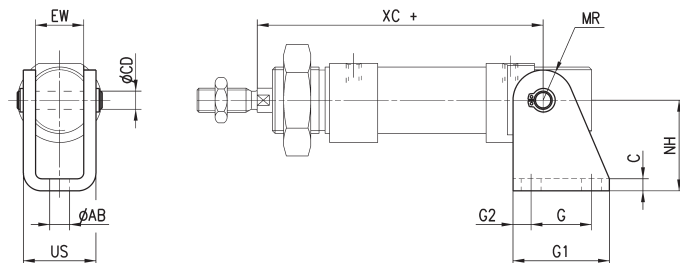
DIMENSIONS

Mod.	Ø	AB	C	CD	EW	G	G1	G2	MR	NH	US	XC+
I-94-12-16	16	5,5	3	6	12	15	25	5	7	27	18,1	82
I-94-20-25	20	6,6	4	8	16	20	32	6	10	30	24,1	95
I-94-20-25	25	6,6	4	8	16	20	32	6	10	30	24,1	104

Rod Fork End Mod. G-94/90

ISO 8140
Material: stainless steel 303

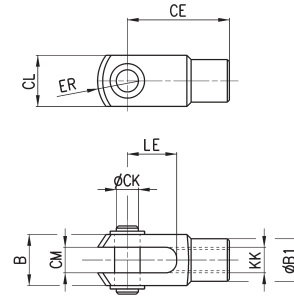
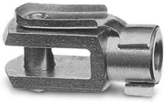

DIMENSIONS											
Mod.	Ø	CK	LE	KK	CM	ER	CE	CL	B	B1	
G-94-12-16	16	6	12	M6x1	6	7	24	12	16	10	
G-94-20	20	8	16	M8x1,25	8	10	32	16	22	14	
G-90-25-32	25	10	20	M10x1,25	10	12	40	20	26	18	

Swivel Ball Joint Mod. GA-94/90

ISO 8139
Materials:
- stainless steel 304 bracket
- stainless steel 420 spherical ring
- sintered bronze bushing

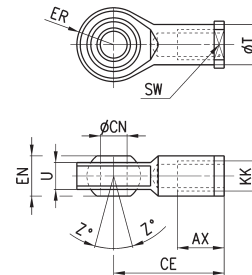

DIMENSIONS											
Mod.	Ø	CN	U	EN	ER	AX	CE	KK	T	Z	SW
GA-94-12-16	16	6	7	9	10	12	30	M6x1	10	6,5	11
GA-94-20	20	8	9	12	12	16	36	M8x1,25	12,5	6,5	14
GA-90-32	25	10	10,5	14	14	20	43	M10x1,25	15	6,5	17

Piston Rod Lock Nut Mod. U-94/90

ISO 4035
Material: stainless steel 304

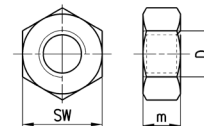

DIMENSIONS				
Mod.	Ø	D	m	SW
U-94-12-16	16	M6x1	4	10
U-94-20	20	M8x1,25	5	13
U-90-25-32	25	M10x1,25	6	17

Nose Nut Mod. V-94 and Mod. U-90

ISO 4035
Material: stainless steel 304

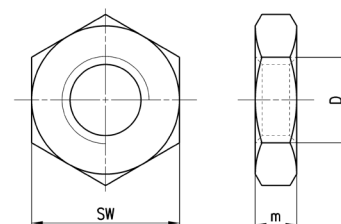
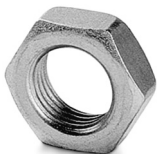

DIMENSIONS				
Mod.	Ø	D	m	SW
U-90-50-63	16	M16x1,5	8	24
V-94-20-25	20-25	M22x1,5	10	32