

# Series 90 stainless steel cylinders

Single- and double-acting, cushioned, magnetic  
 ø 32, 40, 50, 63, 80, 100 and 125 mm



- » In compliance with ISO 15552 standards and with the previous DIN/ISO 6431/VDMA 24562 standards
- » Clean design
- » Stainless steel AISI 316
- » End-stroke cushioning

**Series 90 cylinders are suitable for use in harsh environmental conditions as in the offshore, naval, pharmaceutical, nuclear and food industries.**

This series of cylinders is normally equipped with end of stroke buffers with adjustable pneumatic cushioning. Moreover, they are equipped with a mechanical cushioning that makes the impact of the piston less noisy as it reaches the end of the stroke.

## GENERAL DATA

<b>Construction</b>	with tie-rods
<b>Operation</b>	single-acting or double-acting
<b>Materials</b>	- end blocks, barrel and rod in stainless steel AISI 316 - seals in NBR - plastic guiding element, NSF H1-certified lubricant
<b>Mountings</b>	several types of cylinders mounting brackets available
<b>Stroke</b>	25 ÷ 800 mm
<b>Operating temperature</b>	0°C ÷ 80°C (with dry air - 20°C)
<b>Operating pressure</b>	1 ÷ 10 bar
<b>Speed</b>	10 ÷ 1000 mm/sec (no load)
<b>Media</b>	Filtered air, without lubrication. If lubricated air is used, it is recommended to use oil ISOVG32. Once applied the lubrication should never be interrupted.

### STANDARD STROKES FOR CYLINDER SERIES 90

✕ = Double-acting  
• = Single-acting

STANDARD STROKES													
Ø	25	50	80	100	125	150	160	200	250	300	320	400	500
32	✕•	✕•	✕	✕	✕	✕	✕	✕	✕	✕	✕	✕	✕
40	✕•	✕•	✕	✕	✕	✕	✕	✕	✕	✕	✕	✕	✕
50	✕•	✕•	✕	✕	✕	✕	✕	✕	✕	✕	✕	✕	✕
63	✕•	✕•	✕	✕	✕	✕	✕	✕	✕	✕	✕	✕	✕
80	✕•	✕•	✕	✕	✕	✕	✕	✕	✕	✕	✕	✕	✕
100	✕•	✕•	✕	✕	✕	✕	✕	✕	✕	✕	✕	✕	✕
125		✕•	✕	✕	✕	✕	✕	✕	✕	✕	✕	✕	✕

### CODING EXAMPLE

<b>90</b>	<b>M</b>	<b>2</b>	<b>A</b>	<b>050</b>	<b>A</b>	<b>0200</b>	
<b>90</b>	SERIES						
<b>M</b>	VERSION M = standard, magnetic						
<b>2</b>	OPERATION 1 = single-acting, front spring 2 = double-acting, front and rear cushions 6 = double-acting, through-rod, front and rear cushions				PNEUMATIC SYMBOLS CS06 CD09 CD13		
<b>A</b>	MATERIALS A = stainless steel AISI 316, seals in NBR V = stainless steel AISI 316, all seals in FKM (150°C)						
<b>050</b>	BORE 032 = 32 mm - 040 = 40 mm - 050 = 50 mm - 063 = 63 mm 080 = 80 mm - 100 = 100 mm - 125 = 125 mm						
<b>A</b>	TYPE OF DESIGN A = standard with piston rod lock nut Mod. U						
<b>0200</b>	STROKE (see the table)						
	= standard V = rod seal in FKM						

### PNEUMATIC SYMBOLS

The pneumatic symbols which have been indicated in the CODING EXAMPLE are shown below.

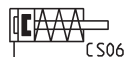
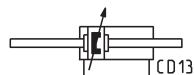
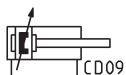

**ACCESSORIES FOR STAINLESS STEEL CYLINDERS SERIES 90**

Foot mount Mod. B

 Front and rear flange  
Mod. D-E

 Rear trunnion, female  
Mod. C-H

 Rear trunnion, male  
Mod. L

 Tight rear female tr.  
bracket Mod. CR

 Male tr. bracket with  
swivel ball joint Mod. R

 90° male tr. bracket + sw.  
ball joint Mod. ZCR

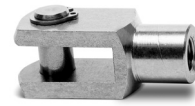
 90° male trunnion  
Mod. ZC

Rod fork end Mod. G-90



Clevis pin Mod. S-90



 Anti-rotation clevis pin  
Mod. SR-90

 Swivel ball joint  
Mod. GA-90

 Piston rod lock nut  
Mod. U-90

All accessories are supplied separately, except for the piston rod lock nut Mod. U

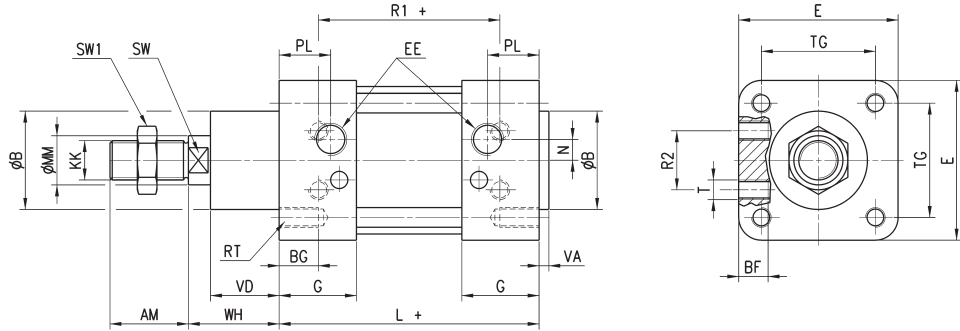
Cylinders Series 90



+ = add the stroke

DIMENSIONS

Ø	AM	B	BF	BG	E	EE	G	KK	L	MM	N	PL	RT	R1	R2	SW	SW1	T	TG	VA	VD	WH
32	22	30	10	16	45	G1/8	28	M10x1.25	94	12	4.5	14	M6	64	16	10	17	M5	32.5	4	20	26
40	24	35	10	16	55	G1/4	31.5	M12x1.25	105	16	5.5	16	M6	70	21	13	19	M6	38	4	22	30
50	32	40	12	16	65	G1/4	31.5	M16x1.5	106	20	8.5	21	M8	74	24	17	24	M8	46.5	4	28	37
63	32	45	12	16	80	G3/8	35	M16x1.5	121	20	8.5	22	M8	85	33	17	24	M8	56.5	4	28	37
80	40	45	15	16	95	G3/8	36	M20x1.5	128	25	8.5	23	M10	92	34	21	30	M10	72	4	34	46
100	40	55	15	16	115	G1/2	41	M20x1.5	138	25	10	26	M10	100	58	21	30	M10	89	4	38	51
125	54	60	24	20	140	G1/2	45	M27x2	160	32	12.5	30	M12	110	65	27	41	M12	110	5	50	65

Cylinders Series 90 - through-rod

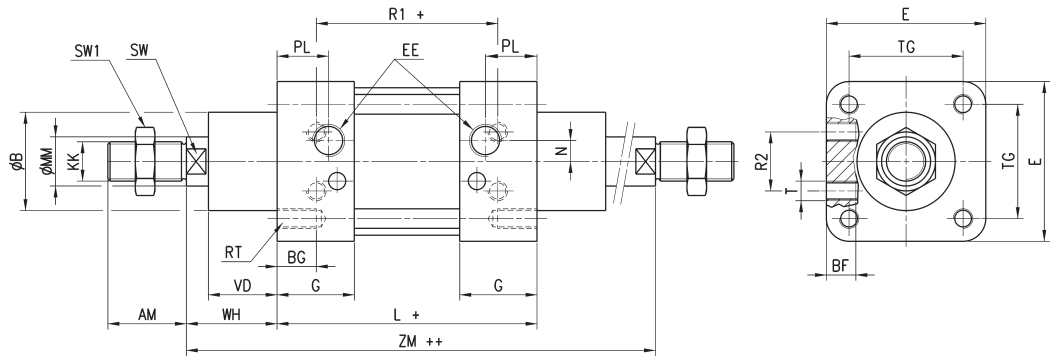

+ = add the stroke once  
++ = add the stroke twice

DIMENSIONS

Ø	AM	B	BF	BG	E	EE	G	KK	L	MM	N	PL	RT	R1	R2	SW	SW1	T	TG	VD	WH	ZM
32	22	30	10	16	45	G1/8	28	M10x1.25	94	12	4.5	14	M6	64	16	10	17	M5	32.5	20	26	146
40	24	35	10	16	55	G1/4	31.5	M12x1.25	105	16	5.5	16	M6	70	21	13	19	M6	38	22	30	165
50	32	40	12	16	65	G1/4	31.5	M16x1.5	106	20	8.5	21	M8	74	24	17	24	M8	46.5	28	37	180
63	32	45	12	16	80	G3/8	35	M16x1.5	121	20	8.5	22	M8	85	33	17	24	M8	56.5	28	37	195
80	40	45	15	16	95	G3/8	36	M20x1.5	128	25	8.5	23	M10	92	34	21	30	M10	72	34	46	220
100	40	55	15	16	115	G1/2	41	M20x1.5	138	25	10	26	M10	100	58	21	30	M10	89	38	51	240
125	54	60	24	20	140	G1/2	45	M27x2	160	32	12.5	30	M12	110	65	27	41	M12	110	50	65	290

**Foot mount Mod. B**

Material: stainless steel 316

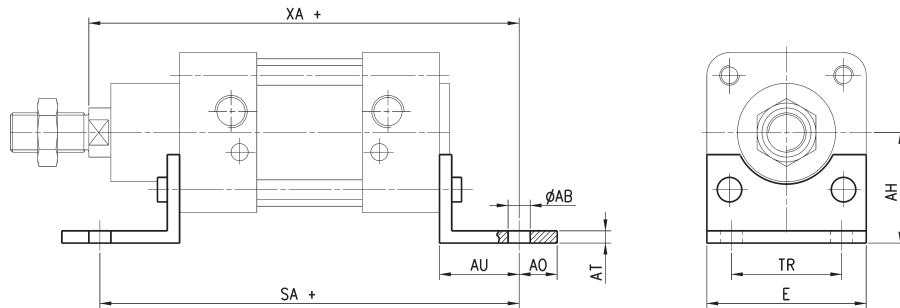

Supplied with:  
2x feet  
4x screws  
+ = add the stroke

**DIMENSIONS**

Mod.	Ø	ØAB	AH	AO	AT	AU	E	TR	SA+	XA+
<b>B-90-32</b>	32	7	32	11	4	24	45	32	142	144
<b>B-90-40</b>	40	9	36	8	4	28	52	36	161	163
<b>B-90-50</b>	50	9	45	15	5	32	65	45	170	175
<b>B-90-63</b>	63	9	50	13	5	32	75	50	185	190
<b>B-90-80</b>	80	12	63	14	6	41	95	63	210	215
<b>B-90-100</b>	100	14	75	16	6	41	115	75	220	230
<b>B-90-125</b>	125	16	90	25	8	45	140	90	250	270

**Front and rear flange Mod. D-E**

Material: stainless steel 316

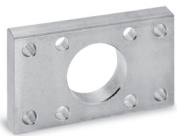

Supplied with:  
1x flange  
4x screws  
+ = add the stroke

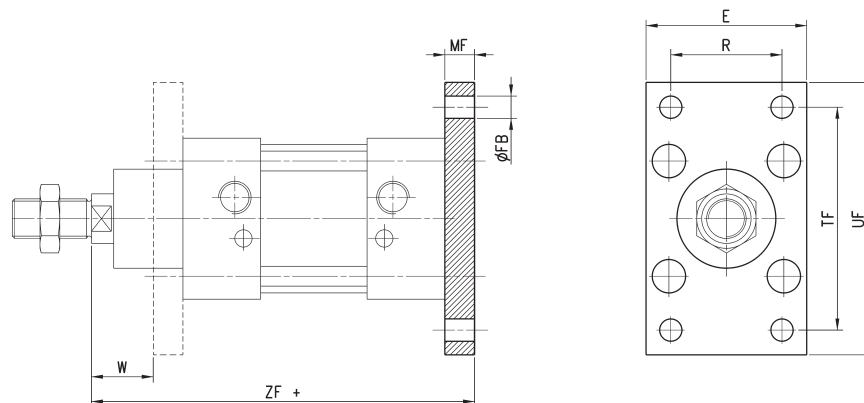
**DIMENSIONS**

Mod.	Ø	E	ØFB	MF	TF	UF	W	ZF+	R
<b>D-E-90-32</b>	32	45	7	10	64	80	16	130	32
<b>D-E-90-40</b>	40	52	9	10	72	90	20	145	36
<b>D-E-90-50</b>	50	65	9	12	90	110	25	155	45
<b>D-E-90-63</b>	63	75	9	12	100	120	25	170	50
<b>D-E-90-80</b>	80	95	12	15	126	150	30	190	63
<b>D-E-90-100</b>	100	115	14	15	150	170	35	205	75
<b>D-E-90-125</b>	125	140	16	20	180	205	45	245	90

Rear trunnion, female Mod. C-H

Material: stainless steel 316



Supplied:  
1x female trunnion  
4x screws

+ = add the stroke

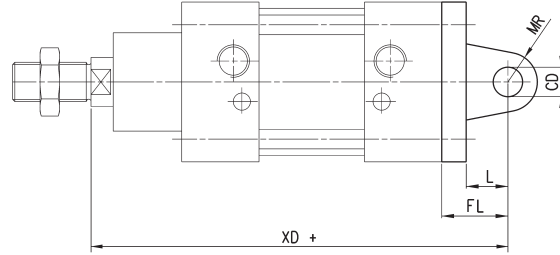
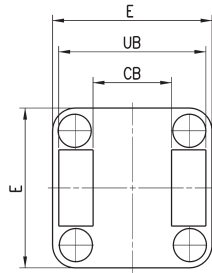

DIMENSIONS									
Mod.	Ø	CB	CD	E	FL	L	MR	UB	XD+
C-H-90-32	32	26	10	45	22	12	10	45	142
C-H-90-40	40	28	12	55	25	15	12	52	161
C-H-90-50	50	32	12	65	27	17	12	60	170
C-H-90-63	63	40	16	75	32	20	16	70	185
C-H-90-80	80	50	16	95	36	22	16	90	210
C-H-90-100	100	60	20	115	41	25	20	110	230
C-H-90-125	125	70	25	140	50	30	25	130	275

Rear trunnion, male Mod. L

Material: stainless steel 316



Supplied:  
1x male trunnion  
4x screws

+ = add the stroke

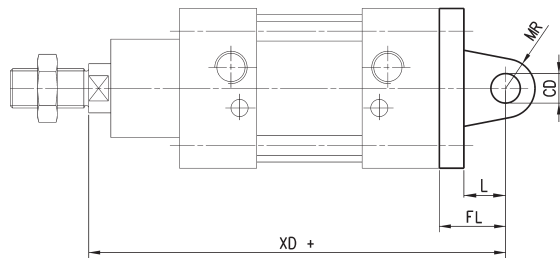
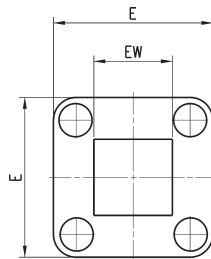

DIMENSIONS									
Mod.	Ø	EW	CD	E	FL	L	MR	XD+	
L-90-32	32	26	10	45	22	12	10	142	
L-90-40	40	28	12	55	25	15	12	161	
L-90-50	50	32	12	65	27	17	12	170	
L-90-63	63	40	16	75	32	20	16	185	
L-90-80	80	50	16	95	36	22	16	210	
L-90-100	100	60	20	115	41	25	20	230	
L-90-125	125	70	25	140	50	30	25	275	

**Tight rear female trunnion bracket Mod. CR**

Material: stainless steel 316

 Supplied with:  
 1x female trunnion bracket  
 4x screws

+ = add the stroke

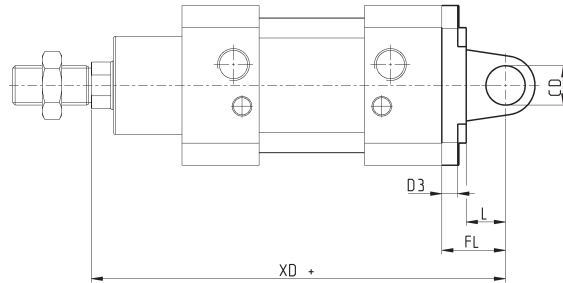
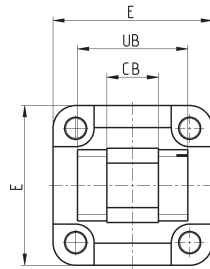
**DIMENSIONS**

Mod.	Ø	CB	CD	E	FL	L	UB	XD	D3
<b>CR-90-32</b>	32	14	10	45	22	12	34	142	5.5
<b>CR-90-40</b>	40	16	12	55	25	25	40	161	5.5
<b>CR-90-50</b>	50	21	16	65	27	27	45	170	6.5
<b>CR-90-63</b>	63	21	16	75	32	32	51	185	6.5
<b>CR-90-80</b>	80	25	20	95	36	36	65	210	10
<b>CR-90-100</b>	100	25	20	114	41	41	75	230	10
<b>CR-90-125</b>	125	37	30	140	50	50	97	275	10

**Male trunnion bracket with swivel ball joint Mod. R**

Material: stainless steel 316

 Supplied with:  
 1x male trunnion bracket  
 4x screws

+ = add the stroke

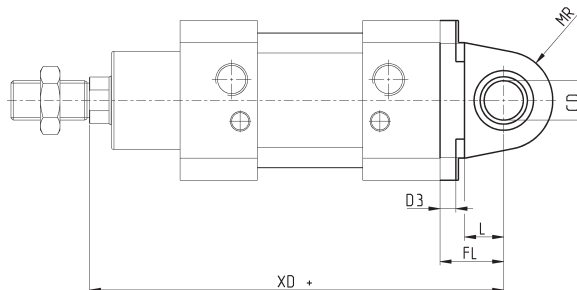
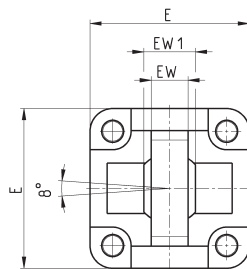
**DIMENSIONS**

Mod.	Ø	EW	EW1	CD	E	FL	L	MR	XD	D3
<b>R-90-32</b>	32	10.5	14	10	45	22	12	15	142	5.5
<b>R-90-40</b>	40	12	16	12	55	25	15	18	161	5.5
<b>R-90-50</b>	50	15	21	16	65	27	17	20	170	6.5
<b>R-90-63</b>	63	15	21	16	75	32	20	23	185	6.5
<b>R-90-80</b>	80	18	25	20	95	36	22	27	210	10
<b>R-90-100</b>	100	18	25	20	115	41	25	30	230	10
<b>R-90-125</b>	125	25	37	30	140	50	30	40	275	10

90° male trunnion bracket with swivel ball joint Mod. ZCR

Material: stainless steel 316



Supplied with:  
1x male trunnion bracket  
4x screws

+ = add the stroke

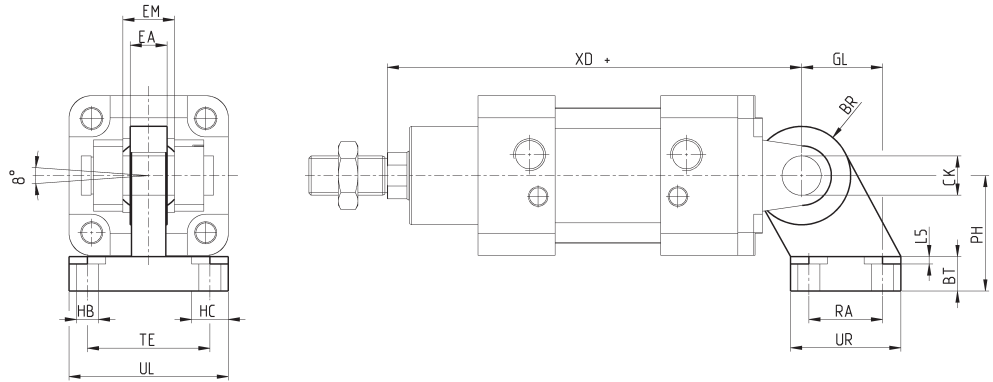

DIMENSIONS

Mod.	Ø	UL	TE	EA	EM	XD	GL	BR	CK	PH	L5	BT	HB	RA	UR	HC
ZCR-90-32	32	51	38	10.5	14	142	21	15	10	32	1.5	10	6.6	18	31	11
ZCR-90-40	40	54	41	12	16	160	24	18	12	36	1.5	10	6.6	22	35	11
ZCR-90-50	50	65	50	15	21	170	33	20	16	45	1.5	12	9	30	45	15
ZCR-90-63	63	67	52	15	21	190	37	23	16	50	1.5	12	9	35	50	15
ZCR-90-80	80	86	66	18	25	210	47	27	20	63	2.5	14	11	40	60	18
ZCR-90-100	100	96	76	18	25	230	55	30	20	71	2.5	15	11	50	70	18
ZCR-90-125	125	124	94	25	37	275	70	40	30	90	3	20	13.5	60	90	20

90° male trunnion Mod. ZC

Material: stainless steel 316



Supplied with:  
1x male support

+ = add the stroke

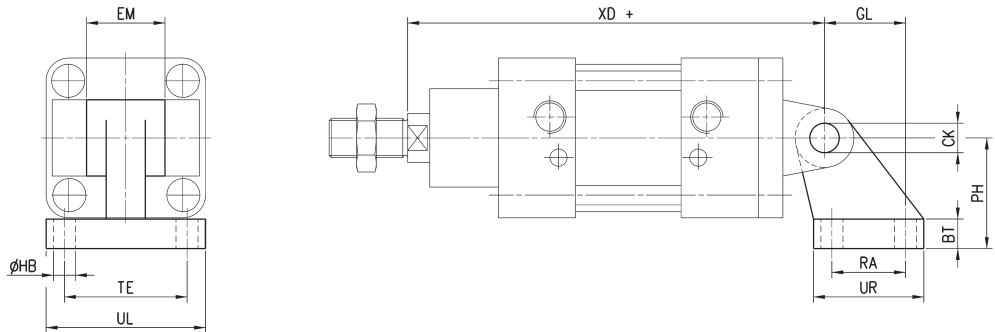

DIMENSIONS

Mod.	Ø	BT	CK	EM	GL	ØHB	PH	RA	TE	UL	UR	XD+
ZC-90-32	32	8	10	26	21	6,6	32	18	38	51	31	142
ZC-90-40	40	10	12	28	24	6,6	36	22	41	54	35	161
ZC-90-50	50	12	12	32	33	9	45	30	50	65	45	170
ZC-90-63	63	12	16	40	37	9	50	35	52	67	50	185
ZC-90-80	80	14	16	50	47	11	63	40	66	86	60	210
ZC-90-100	100	15	20	60	55	11	71	50	76	96	70	230
ZC-90-125	125	20	25	70	70	14	90	60	94	124	90	275

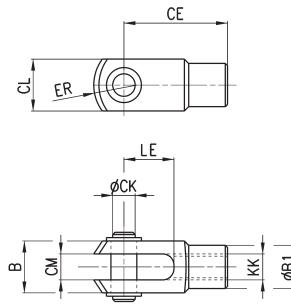
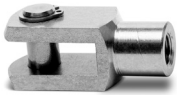

**Rod fork end Mod. G-90**

 Material: stainless steel 303  
 ISO 8140

**DIMENSIONS**

Mod.	Ø	ØCK	LE	CM	CL	ER	CE	KK	B	ØB1
<b>G-90-25-32</b>	32	10	20	10	20	12	40	M10x1,25	26	18
<b>G-90-40</b>	40	12	24	12	24	14	48	M12x1,25	31	20
<b>G-90-50-63</b>	50-63	16	32	16	32	19	64	M16x1,5	39	26
<b>G-90-80-100</b>	80-100	20	40	20	40	25	80	M20x1,5	50	34
<b>G-90-125</b>	125	30	54	30	55	38	110	M27x2	67	48

**Clevis pin Mod. S-90**

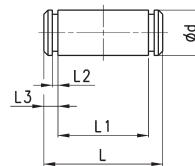
Material: stainless steel 303

**DIMENSIONS**

Mod.	Ø	Ød	L	L1	L2	L3
<b>S-90-32</b>	32	10	53	46	1,1	3
<b>S-90-40</b>	40	12	60	53	1,1	3
<b>S-90-50</b>	50	12	68	61	1,1	3
<b>S-90-63</b>	63	16	78	71	1,1	3
<b>S-90-80</b>	80	16	98	91	1,1	3
<b>S-90-100</b>	100	20	118	111	1,3	5
<b>S-90-125</b>	125	25	139	132	1,3	4,2

### Antirotating clevis pin Mod. SR-90

Supplied with:  
 1x antirotating clevis pin  
 (stainless steel 316)  
 1x seeger (steel)

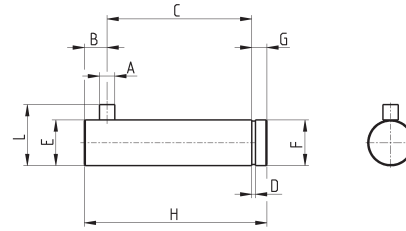

#### DIMENSIONS

Mod.	Ø	A	B	C	D	E	F	G	H	L
<b>SR-90-32</b>	32	3	4.5	32.5	1.1	10	9.6	4	41	14
<b>SR-90-40</b>	40	4	6	38	1.1	12	11.5	4	48	46
<b>SR-90-50</b>	50	4	6	43	1.1	16	15.2	5	54	20
<b>SR-90-63</b>	63	4	6	49	1.1	16	15.2	5	60	20

### Swivel ball joint Mod. GA-90

ISO 8139

Materials:  
 - stainless steel 304 bracket  
 - stainless steel 420 spherical ring  
 - sintered bronze bushing

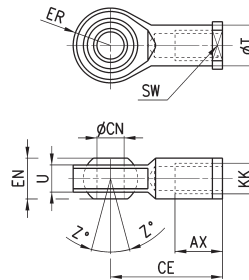

#### DIMENSIONS

Mod.	Ø	ØCN	U	EN	ER	AX	CE	KK	ØT	Z	SW
<b>GA-90-32</b>	32	10	10,5	14	14	20	43	M10x1,25	15	6,5	17
<b>GA-90-40</b>	40	12	12	16	16	22	50	M12x1,25	17,5	6,5	19
<b>GA-90-50-63</b>	50-63	16	15	21	21	28	64	M16x1,5	22	7,5	22
<b>GA-90-80-100</b>	80-100	20	18	25	21	33	77	M20x1,5	27,5	7	30
<b>GA-90-125</b>	125	30	25	35	35	51	110	M27x2	40	7,5	41

### Piston rod lock nut Mod. U-90

ISO 4035

Material: stainless steel 304

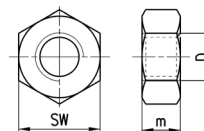

#### DIMENSIONS

Mod.	Ø	D	m	SW
<b>U-90-25-32</b>	32	M10x1,25	6	17
<b>U-90-40</b>	40	M12x1,25	7	19
<b>U-90-50-63</b>	50-63	M16x1,5	8	24
<b>U-90-80-100</b>	80-100	M20x1,5	9	30
<b>U-90-125</b>	125	M27x2	12	41