

# Series 40 cylinders

Double acting, cushioned, magnetic  
 Ø 160 - 200 - 250 - 320 mm

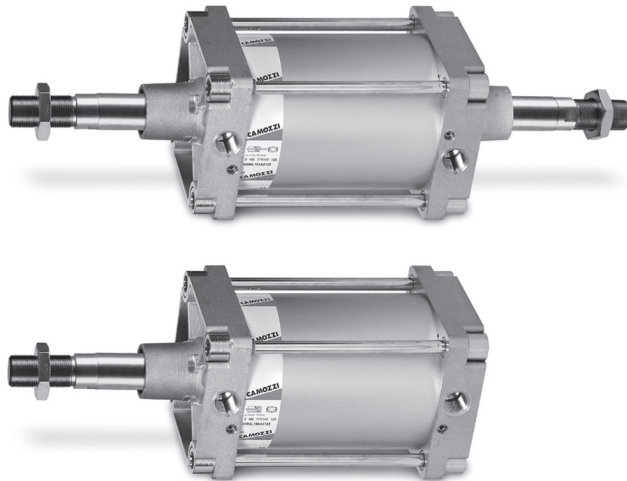

- » In compliance with ISO 15552 standards and with the previous DIN/ISO 6431 - VDMA 24562 standards
- » Adjustable pneumatic cushioning
- » Rolled stainless steel rod (Ø 160 - 200 mm)
- » Chrome plated steel rod (Ø 250 - 320 mm)
- » Rod scraper in brass

**Series 40 cylinders have been designed in compliance with ISO 15552 standards and with the previous DIN/ISO 6431 - VDMA 24562 standards.**

**A permanent magnet on the piston of these cylinders is able to send, through proximity switches mounted on the cylinder sliding axis, electrical signals to indicate its position.**

This series is normally equipped with end-stroke cushioning which can be adjusted through a screw on the end block.

In order to quieten the impact of the piston on the end block, these cylinders are also equipped with mechanical cushioning.

## GENERAL DATA

<b>Type of construction</b>	with tie-rods
<b>Operation</b>	double-acting
<b>Materials</b>	AL end blocks and piston, rolled stainless steel AISI 420B (Ø 160-200 mm) or chrome plated steel (Ø250-320 mm) piston rod, zinc-plated steel piston rod nut, anodized AL tube, zinc-plated steel tie-rods and tie-rod nuts, NBR-PU rod - piston - cushion seals, brass rod scraper
<b>Mounting</b>	with tie-rods, front flange, rear flange, feet, centre trunnion, front and rear trunnion, swivel combination
<b>Strokes min - max</b>	10 ÷ 2500 mm
<b>Operating temperature</b>	0°C ÷ 80°C (with dry air -20°C)
<b>Operating pressure</b>	1 ÷ 10 bar
<b>Speed</b>	10 ÷ 500 mm/sec (without load)
<b>Fluid</b>	filtered air, without lubrication. If lubricated air is used, it is recommended to use oil ISOVG32. Once applied the lubrication should never be interrupted.

**STANDARD STROKES FOR SERIES 40 CYLINDERS**

■ = double-acting

Ø	25	50	75	80	100	125	150	160	200	250	300	320	400	500
160		■		■	■		■		■		■		■	■
200		■			■				■		■			
250		■			■				■		■			
320		■			■				■		■			

**CODING EXAMPLE**

<b>40</b>	<b>M</b>	<b>2</b>	<b>L</b>	<b>160</b>	<b>A</b>	<b>0200</b>	
-----------	----------	----------	----------	------------	----------	-------------	--

<b>40</b>	SERIES
<b>M</b>	VERSION M = standard, magnetic
<b>2</b>	OPERATION 2 = double-acting, front and rear cushions 3 = double-acting, no cushion 4 = double-acting, rear cushions 5 = double-acting, front cushion 6 = double-acting, through-rod, front and rear cushions 8 = double-acting, through-rod, no cushion
	PNEUMATIC SYMBOLS CD09 CD08 CD10 CD11 CD13 CD12
<b>L</b>	MATERIALS L = see the general data on page 1/1.10.01 T = stainless steel AISI 420B tie-rods - stainless steel AISI 303 tie-rod nuts C = rolled stainless steel AISI 303 piston rod, stainless steel AISI 304 piston rod nut U = rolled stainless steel AISI 303 piston rod, stainless steel AISI 304 piston-rod nut, stainless steel AISI 420B tie-rods, stainless steel AISI 303 tie-rod nuts W = rolled stainless steel AISI 304 piston rod, stainless steel AISI 304 piston-rod nut, stainless steel AISI 420B tie-rods, stainless steel AISI 303 tie-rod nuts  Note: the rod of cylinders with bore of 250 and 320 mm is in C40 chrome plated steel.
<b>160</b>	BORE 160 = 160 mm - 200 = 200 mm - 250 = 250 mm - 320 = 320 mm
<b>A</b>	TYPE OF BRACKET A = standard      F = cylinder with centre trunnion
<b>0200</b>	STROKE (see the table)  = standard V = FKM rod seals    W = all FKM seals +130°C    C = PU coated cylinder. Colour: Grey * G = with brass rod scraper (chrome plated stainless steel AISI 420B rod, NBR rod seal) [ Ø 250 and 320 excluded ] ( _ _ _ ) = extended piston rod _ _ _ mm  Notes: the C version is available on request. For further details, contact our technical dept. The W and C versions are available for diameters 160 and 200 only.

**PNEUMATIC SYMBOLS**

The pneumatic symbols which have been indicated in the CODING EXAMPLE are shown below.

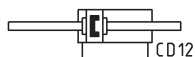
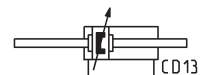
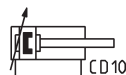
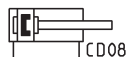
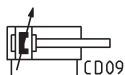

ACCESSORIES FOR SERIES 40 CYLINDERS



Clevis pin Mod. S

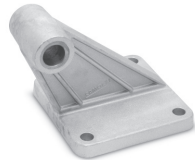

90° Swivel combination Mod. ZS



Counter bracket for centre trunnion Mod. BF

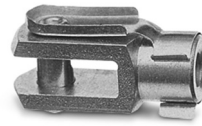

Rod fork end Mod. G

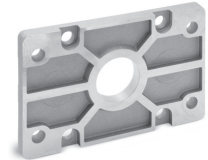

Front and rear flange Mod. D-E



Centre trunnion Mod. F



Foot mount Mod. B



Swivel ball joint Mod. GA

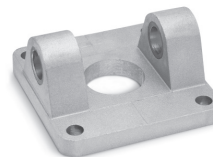

Female trunnion Mod. C-H



Piston rod lock nut Mod. U

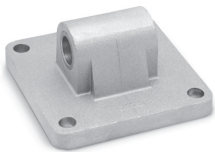

Rear trunnion, male Mod. L



Self aligning rod Mod. GK

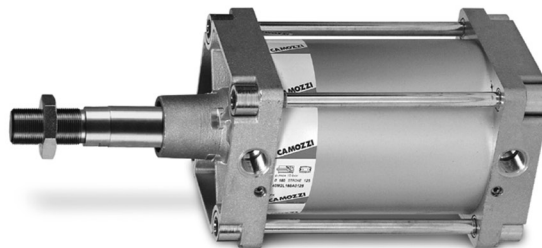
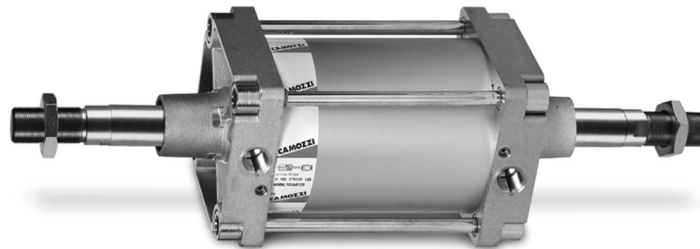

All accessories are supplied separately except for piston rod lock nut Mod. U. For proximity switches and brackets for sensors see the section 1/9.

## Series 40 cylinders



+ = add the stroke

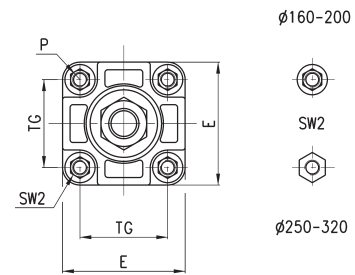
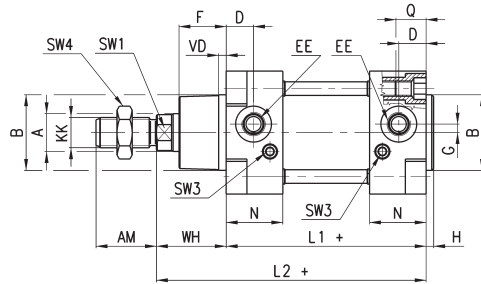

## DIMENSIONS

$\phi$	A	KK	$\phi$ B	D	G	F	AM	H	EE	WH	L1+	L2+	VD	N	P	Q	TG	E	SW1	SW2	SW3	SW4	front/rear cushion strokes
160	40	M36x2	65	25	12	53.5	72	6	G3/4	80	180	260	6	45	M16	26	140	176	36	17	4	55	29 / 36
200	40	M36x2	75	25	12	63.5	72	6	G3/4	95	180	275	6	45	M16	26	175	216	36	17	4	55	44 / 42
250	50	M42x2	90	31	12	67	84	10	G1	105	200	305	6	60	M20	30	220	270	46	36	4	65	50 / 50
320	63	M48x2	110	31	12	83	96	10	G1	120	220	340	12	55,5	M24	30	270	340	55	41	-	75	56 / 56

## Series 40 cylinders - through-rod

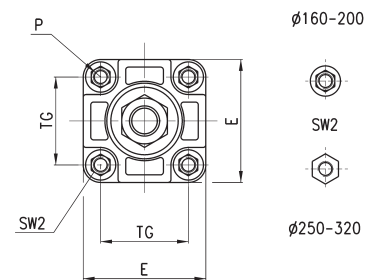
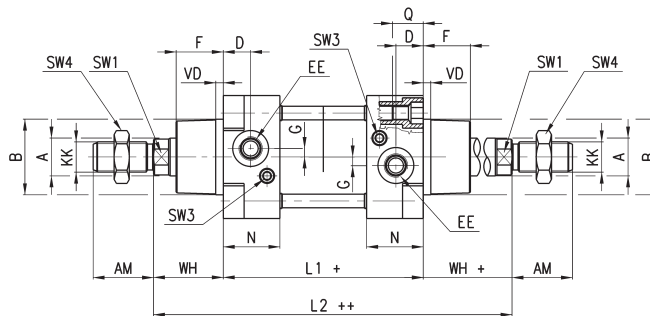
 + = add the stroke once  
 ++ = add the stroke twice

## DIMENSIONS

$\phi$	A	KK	$\phi$ B	D	G	F	AM	EE	WH	L1+	L2++	VD	N	P	Q	TG	E	SW1	SW2	SW3	SW4	front/rear cushion strokes
160	40	M36x2	65	25	12	53.5	72	G3/4	80	180	340	6	45	M16	26	140	176	36	17	4	55	29 / 36
200	40	M36x2	75	25	12	63.5	72	G3/4	95	180	370	6	45	M16	26	175	216	36	17	4	55	44 / 42
250	50	M42x2	90	31	12	67	84	G1	105	200	410	6	60	M20	30	220	270	46	36	4	65	50 / 50
320	63	M48x2	110	31	12	83	96	G1	120	200	?	12	55,5	M24	30	270	340	55	41	-	75	56 / 56

Series 40 cylinders with centre trunnion Mod. F



+ = add the stroke  
 + 1/2 = add the stroke half

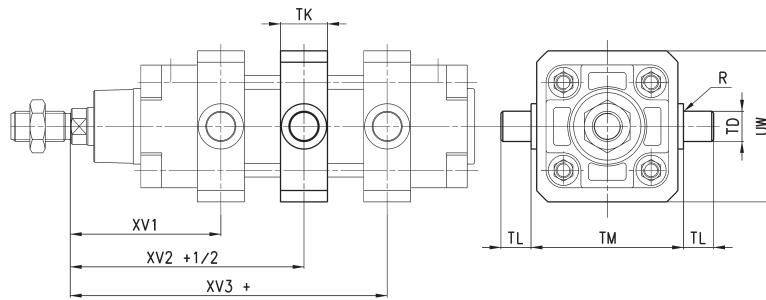

DIMENSIONS										
∅	XV1	XV2+ 1/2	XV3+	TM	TK	TD	TL	UW	R	NOTE
160	145	170	195	200	40	32	32	190	2	
200	160	185	210	250	40	32	32	240	2	
250	185	205	225	320	50	40	40	300	-	mounting with 4 threaded tie-rods
320	210,5	230	249,5	400	70	50	50	400	-	mounting with 4 threaded tie-rods

**Foot mount Mod. B**

Supplied with:  
2x feet in black-painted steel  
(cataphoresis)  
4x white zinc plating screws

For diameters 250 and 320 white zinc plating

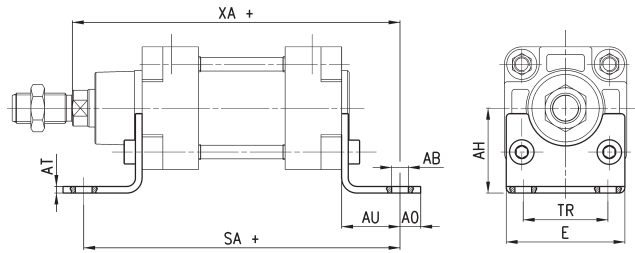

+ = add the stroke

**DIMENSIONS**

Mod.	∅	AT	SA+	XA+	TR	E	∅AB	AH	AO	AU
<b>B-41-160</b>	160	10	300	320	115	175	18.5	115	25	60
<b>B-41-200</b>	200	12	320	345	135	238	24	135	35	70
<b>B-41-250</b>	250	14	350	380	165	270	26	165	25	75
<b>B-41-320</b>	320	20	390	425	200	353	35	200	45	85

**Front and rear flange Mod. D-E**

Supplied with:  
1x flange  
4x screws

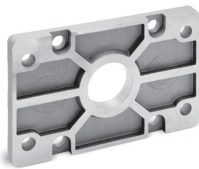

+ = add the stroke

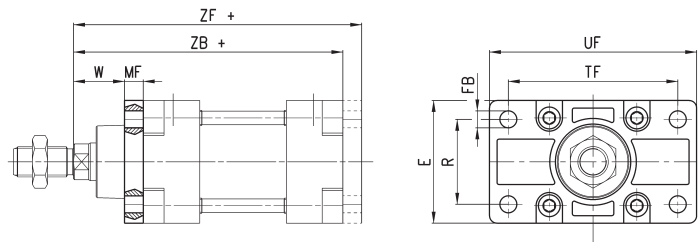
**DIMENSIONS**

Mod.	∅	W	MF	ZB+	TF	R	UF	E	∅FB	ZF+	Material
<b>D-E-41-160</b>	160	60	20	260	230	115	276	175	18	280	aluminium
<b>D-E-41-200</b>	200	70	25	275	270	135	312	215	22	300	aluminium
<b>D-E-41-250</b>	250	80	25	305	330	165	400	285	26	330	zinc-plated steel
<b>D-E-41-320</b>	320	90	30	340	400	200	470	334	33	370	stainless steel 304

**Front and rear female trunnion Mod. C-H**

Supplied with:  
1x female trunnion in Aluminium  
4x screws

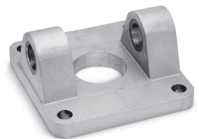

+ = add the stroke

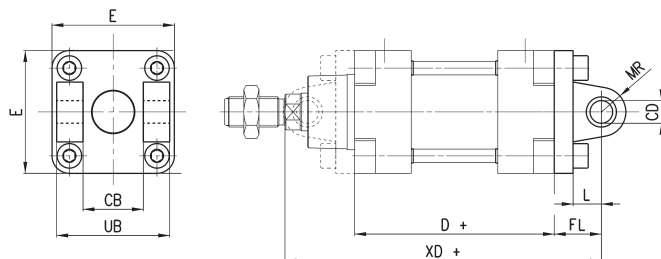

**DIMENSIONS**

Mod.	∅	∅CD	L	FL	D+	XD+	MR	E	CB	UB
<b>C-H-41-160</b>	160	30	35	55	180	315	30	175	90	170
<b>C-H-41-200</b>	200	30	35	60	180	335	30	215	90	170
<b>C-H-41-250</b>	250	40	45	70	200	375	40	270	110	200
<b>C-H-41-320</b>	320	45	50	80	220	420	45	350	120	220

Rear male trunnion Mod. L

Supplied with:  
1x male trunnion in Aluminium \*  
4x screws

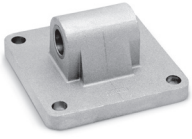
\* For Ø 320 black-painted steel (cataphoresis)



+ = add the stroke

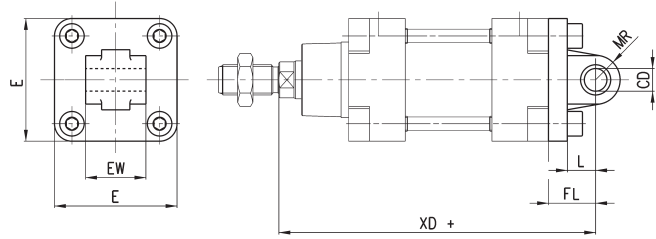

DIMENSIONS

Mod.	Ø	øCD	L	FL	XD+	MR	E	EW
L-41-160	160	30	35	55	315	30	175	90
L-41-200	200	30	35	60	335	30	215	90
L-41-250	250	40	45	70	375	40	270	110
L-41-320	320	45	50	80	420	45	350	110

Centre trunnion Mod. F

Material:  
- zinc-plated steel (Ø 160 and 200)  
- painted cast iron (Ø 250 and 320)



+ = add the stroke

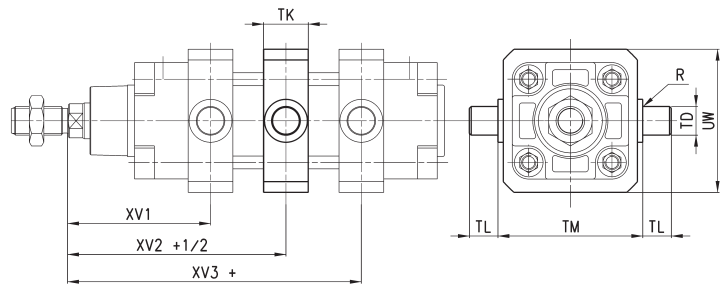

DIMENSIONS

Mod.	Ø	XV1	XV + 1/2	XV3 +	TM	TK	øTD	TL	UW	R	NOTE
F-160	160	145	170	195	200	40	32	32	190	2	
F-200	200	160	185	210	250	40	32	32	240	2	
F-250	250	185	205	225	320	50	40	40	296	-	mounting with 4 threaded tie-rods
F-320	320	210,5	230	249,5	400	70	50	50	400	-	mounting with 4 threaded tie-rods

90° Swivel combination Mod. ZS\*

\* not according to standard

Supplied with:  
1x 45° swivel combination in Aluminium



+ = add the stroke

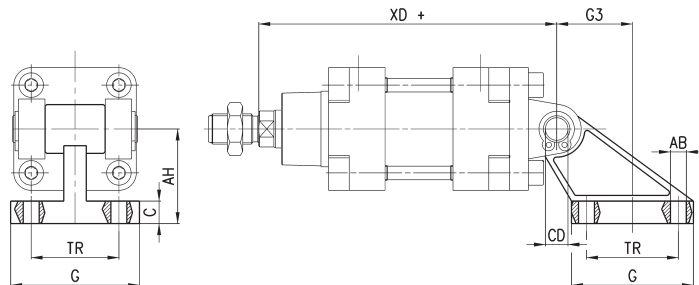

DIMENSIONS

Mod.	Ø	TR	øAB	AH	C	G	øCD	XD +	G3
ZS-160	160	140	18	140	20	180	30	315	105
ZS-200	200	175	18	140	25	220	30	335	125

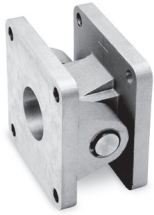
**Swivel combination Mod. C+L+S**

+ = add the stroke

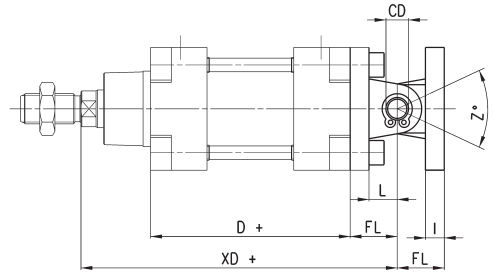
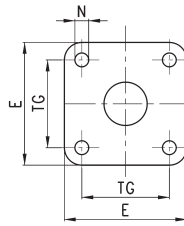
**DIMENSIONS**

Mod.	∅	E	TG	∅N	D+	XD+	∅CD	L	FL	I	Z° (max)
<b>C+L+S</b>	160	175	140	17	180	315	30	35	55	20	25
<b>C+L+S</b>	200	215	175	17	180	335	30	35	60	25	20
<b>C+L+S</b>	250	270	220	25	200	375	40	45	70	25	33
<b>C+L+S</b>	320	350	270	30	220	420	40	50	80	30	30

**Counter bracket for centre trunnion Mod. BF**

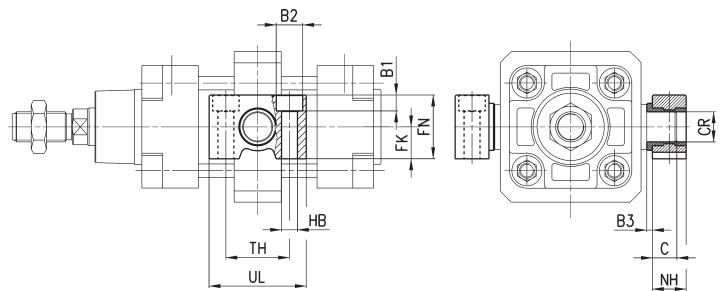
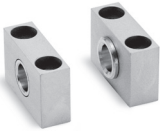
 Supplied with 2 supports  
in Aluminium

**DIMENSIONS**

Mod.	∅	∅CR	NH	C	B3	TH	UL	FK	FN	B1	∅B2	∅HB
<b>BF-160-200</b>	160-200	32	35	17,5	4	60	92	30	60	16	26	18

**Rod fork end Mod. G**

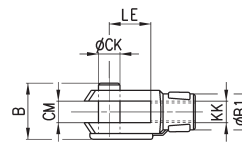
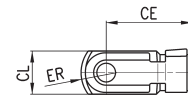
ISO 8140

 Material:  
- zinc-plated steel

**DIMENSIONS**

Mod.	∅	∅CK	LE	CM	CL	ER	CE	KK	B	∅B1
<b>G-160-200</b>	160-200	35	72	35	70	44	144	M36x2	92	60
<b>G-250</b>	250	40	84	40	85	-	168	M42x2	96	70
<b>G-320</b>	320	50	96	50	90	73	192	M48x2	120	80

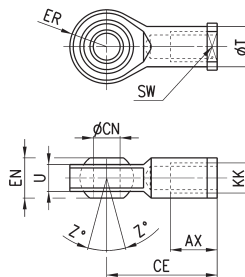

Swivel ball joint Mod. GA

ISO 8139



DIMENSIONS											
Mod.	Ø	øCN	U	EN	ER	AX	CE	KK	ØT	Z	SW
<b>GA-160-200</b>	160-200	35	28	43	40	56	125	M36x2	46	6	50
<b>GA-250</b>	250	40	33	49	-	60	142	M42x2	55	17	55
<b>GA-320</b>	320	50	45	60	58.5	65	160	M48x2	65	12	65

Clevis pin Mod. S

Supplied with:  
1x centering pin  
2x seeger in steel

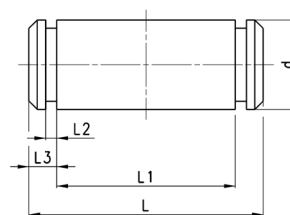

DIMENSIONS							
Mod.	Ø	d	L	L1	L2	L3	
<b>S-160-200</b>	160-200	30	180.5	172	1.6	4.25	stainless steel 303
<b>S-250</b>	250	40	210	202	1.85	4.5	zinc-plated steel
<b>S-320</b>	320	45	236	222	1.85	7	zinc-plated steel

Piston rod lock nut Mod. U

ISO 4035  
Material: zinc-plated steel

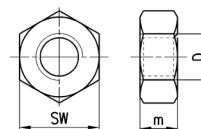

DIMENSIONS				
Mod.	Ø	D	m	SW
<b>U-160-200</b>	160-200	M36x2	14	55
<b>U-250</b>	250	M42x2	16	65
<b>U-320</b>	320	M48x2	24	75

Self aligning rod Mod. GK

Material: zama and zinc-plated steel.

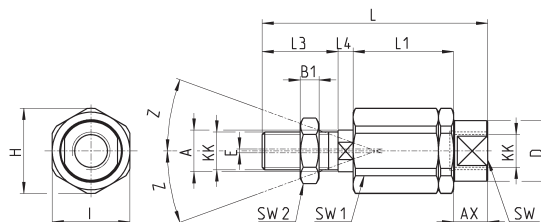

DIMENSIONS																	
Mod.	Ø	KK	L	L1	L3	L4	øA	øD	H	I	SW	SW1	SW2	B1	AX	Z	E
<b>GK-160-200</b>	160-200	M36x2	190	77	72	15.5	39	57	75	70	54	32	55	14	68	4	2