

Popis zboží/obrázky produktu

**Popis****Materiál:**

Šnek z oceli.

Šnekové kolo CuZn37Mn3Al2PbSi-S40.

Provedení:

Šnek pravotočivý, vytvrzený HV 620 – 700, strany a vývrt broušené.

Pokyny k objednání:

Kola/šneky lze kombinovat do sad šnekových kol pouze se stejnou roztečí os a stejným převodovým poměrem.

Upozornění:

Sada šnekového kola se skládá ze šneku a šnekového kola. Vhodné pro vytvoření šnekových převodů s úhlem osy 90°. Pomocí šnekového převodu jsou velmi velké převody do pomalé rychlosti realizovatelné s pouze jedním rychlostním stupněm.

Ozubení má profil boku K. Úhel záběru činí 15°. Sady šnekových kol jsou hotově vyvrtané.

U uvedených výstupních momentů T2 jde o přípustné výstupní momenty na šnekovém kole. Ty platí pro vstupní otáčky 2800 ot/min. šneku.

Sady šnekových kol jsou vhodné pro trvalý provoz při vysokých otáčkách a vysokých točivých momentech.

Odkaz na výkres:

1) broušeno



Popis zboží/obrázky produktu



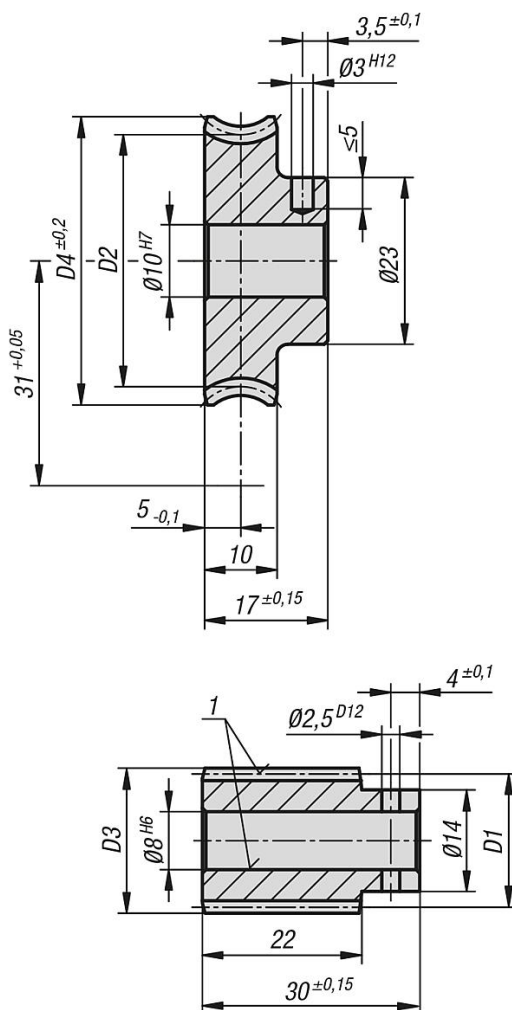



















Výkresy























Přehled zboží

Objednáací číslo	Obrázek	Název	Převodový poměr	Úhel stoupání	Modul	Z1	D1	D3	Z2	D2	D4	Hnací moment T2	Hnací moment T2	Hnací moment T2
												(Nm) minerální tuk	(Nm) minerální olej	(Nm) syntetický olej
22500-311002		šnek	-	45° 15	1,25	10	17,6	20,1	-	-	-	4,4	5,3	6,6
22500-312002		šnekové kolo	2,5:1	45° 15	1,25	-	-	-	25	44,4	46,9	4,4	5,3	6,6
22500-311003		šnek	-	35° 10	1,15	10	19,97	22,27	-	-	-	4,5	5,4	6,7











Přehled zboží

Objednáací číslo	Obrázek	Název	Převodový poměr	Úhel stoupání	Modul	Z1	D1	D3	Z2	D2	D4	Hnací moment T2 (Nm) minerální tuk	Hnací moment T2 (Nm) minerální olej	Hnací moment T2 (Nm) syntetický olej
22500-312003		šnekové kolo	3:1	35° 10	1,15	-	-	-	30	42,03	44,5	4,5	5,4	6,7
22500-311004		šnek	-	25° 24	1,25	7	20,4	22,9	-	-	-	9	10,8	13,5
22500-312004		šnekové kolo	4,28:1	25° 24	1,25	-	-	-	30	41,6	45	9	10,8	13,5
22500-311005		šnek	-	23° 46	1,3	6	19,35	21,95	-	-	-	9,5	11,4	14,2
22500-312005		šnekové kolo	5:1	23° 46	1,3	-	-	-	30	42,65	46,5	9,5	11,4	14,2
22500-311006		šnek	-	18° 13	1,3	5	20,8	23,4	-	-	-	7,6	9,1	11,4
22500-312006		šnekové kolo	6:1	18° 13	1,3	-	-	-	30	41,2	45	7,6	9,1	11,4
22500-311007		šnek	-	20° 32	1,5	4	17,1	20,1	-	-	-	9,7	11,6	14,5
22500-312007		šnekové kolo	7:1	20° 32	1,5	-	-	-	28	44,9	48,8	9,7	11,6	14,5
22500-311008		šnek	-	19° 49	1,75	3	15,5	19	-	-	-	10	12	15
22500-312008		šnekové kolo	8,33:1	19° 49	1,75	-	-	-	25	46,5	51	10	12	15
22500-311010		šnek	-	12° 50	1,4	3	18,9	21,7	-	-	-	9,5	11,4	14,2
22500-312010		šnekové kolo	10:1	12° 50	1,4	-	-	-	30	43,1	47	9,5	11,4	14,2
22500-311012		šnek	-	13° 55	1,25	3	15,6	18,1	-	-	-	12,1	14,5	18,1
22500-312012		šnekové kolo	12:1	13° 55	1,25	-	-	-	36	46,4	50	12,1	14,5	18,1
22500-311015		šnek	-	10° 40	1,5	2	16,2	19,2	-	-	-	10,7	12,8	16
22500-312015		šnekové kolo	15:1	10° 40	1,5	-	-	-	30	45,8	50	10,7	12,8	16
22500-311018		šnek	-	8° 44	1,25	2	16,46	18,96	-	-	-	10,3	12,4	15,4
22500-312018		šnekové kolo	18:1	8° 44	1,25	-	-	-	36	45,54	48,8	10,3	12,4	15,4
22500-311020		šnek	-	7° 49	0,75	3	16,54	18,04	-	-	-	8,3	10	12,4
22500-312020		šnekové kolo	20:1	7° 49	0,75	-	-	-	60	45,46	48	8,3	10	12,4

Přehled zboží

Objednací číslo	Obrázek	Název	Převodový poměr	Úhel stoupání	Modul	Z1	D1	D3	Z2	D2	D4	Hnací moment T2 (Nm) minerální tuk	Hnací moment T2 (Nm) minerální olej	Hnací moment T2 (Nm) syntetický olej
22500-311022		šnek	-	6° 29	1	2	17,7	19,7	-	-	-	9,6	11,5	14,4
22500-312022		šnekové kolo	22:1	6° 29	1	-	-	-	44	44,3	48	9,6	11,5	14,4
22500-311023		šnek	-	7° 29	2	1	15,35	19,35	-	-	-	10,5	12,6	15,7
22500-312023		šnekové kolo	23:1	7° 29	2	-	-	-	23	46,65	52	10,5	12,6	15,7
22500-311024		šnek	-	5° 4	1,75	1	19,8	23,3	-	-	-	9,2	11	13,8
22500-312024		šnekové kolo	24:1	5° 4	1,75	-	-	-	24	42,2	47	9,2	11	13,8
22500-311025		šnek	-	5° 35	1,75	1	18	21,5	-	-	-	9,6	11,5	14,4
22500-312025		šnekové kolo	25:1	5° 35	1,75	-	-	-	25	44	48,5	9,6	11,5	14,4
22500-311028		šnek	-	4° 20	1,5	1	19,85	22,85	-	-	-	9,1	10,9	13,6
22500-312028		šnekové kolo	28:1	4° 20	1,5	-	-	-	28	42,15	46,5	9,1	10,9	13,6
22500-311030		šnek	-	5° 7	1,5	1	16,8	19,8	-	-	-	10,3	12,4	15,4
22500-312030		šnekové kolo	30:1	5° 7	1,5	-	-	-	30	45,2	48,8	10,3	12,4	15,4
22500-311032		šnek	-	4° 45	1,4	1	16,9	19,7	-	-	-	10,2	12,2	15,3
22500-312032		šnekové kolo	32:1	4° 45	1,4	-	-	-	32	45,1	48,8	10,2	12,2	15,3
22500-311038		šnek	-	5° 1	1,25	1	14,3	16,8	-	-	-	11,4	13,7	17,1
22500-312038		šnekové kolo	38:1	5° 1	1,25	-	-	-	38	47,7	51,2	11,4	13,7	17,1
22500-311045		šnek	-	3° 23	1	1	16,93	18,93	-	-	-	9,5	11,4	14,2
22500-312045		šnekové kolo	45:1	3° 23	1	-	-	-	45	45,07	48	9,5	11,4	14,2
22500-311050		šnek	-	3° 3	0,9	1	16,9	18,7	-	-	-	9	10,8	13,5
22500-312050		šnekové kolo	50:1	3° 3	0,9	-	-	-	50	45,1	48	9	10,8	13,5
22500-311055		šnek	-	4° 12	0,9	1	12,3	14,1	-	-	-	10,4	12,5	15,6

Přehled zboží

Objednáací číslo	Obrázek	Název	Převodový poměr	Úhel stoupání	Modul	Z1	D1	D3	Z2	D2	D4	Hnací moment T2 (Nm) minerální tuk	Hnací moment T2 (Nm) minerální olej	Hnací moment T2 (Nm) syntetický olej
22500-312055		šnekové kolo	55:1	4° 12	0,9	-	-	-	55	49,7	52	10,4	12,5	15,6
22500-311060		šnek	-	2° 33	0,75	1	16,9	18,4	-	-	-	8,2	9,8	12,3
22500-312060		šnekové kolo	60:1	2° 33	0,75	-	-	-	60	45,1	48	8,2	9,8	12,3
22500-311070		šnek	-	3° 7	0,7	1	12,9	14,3	-	-	-	9	10,8	13,5
22500-312070		šnekové kolo	70:1	3° 7	0,7	-	-	-	70	49,1	52	9	10,8	13,5
22500-311075		šnek	-	2° 2	0,6	1	16,9	18,1	-	-	-	7,3	8,8	10,9
22500-312075		šnekové kolo	75:1	2° 2	0,6	-	-	-	75	45,1	47	7,3	8,8	10,9
22500-311090		šnek	-	1° 41	0,5	1	17	18	-	-	-	6,4	7,7	9,6
22500-312090		šnekové kolo	90:1	1° 41	0,5	-	-	-	90	45	48	6,4	7,7	9,6
22500-311100		šnek	-	2° 24	0,5	1	11,96	12,96	-	-	-	7,4	8,9	11,1
22500-312100		šnekové kolo	100:1	2° 24	0,5	-	-	-	100	50,04	52,7	7,4	8,9	11,1