

Connector

VEE-CO18-L-G1/8-IG

Part no.:10.01.36.00022

<https://www.schmalz.com/10.01.36.00022>

Homepage > Vacuum Technology for Automation > Vacuum Components > Area Gripping Systems and End Effectors > Vacuum End Effectors

VEE > Connector Lower Shells VEE-CO-L > VEE-CO18-L-G1/8-IG

VEE connector for setting up nodal elements



Pipe diameter: 18 mm

Type: Connector lower shell

Thread G1: G1/8"-F

Design Data

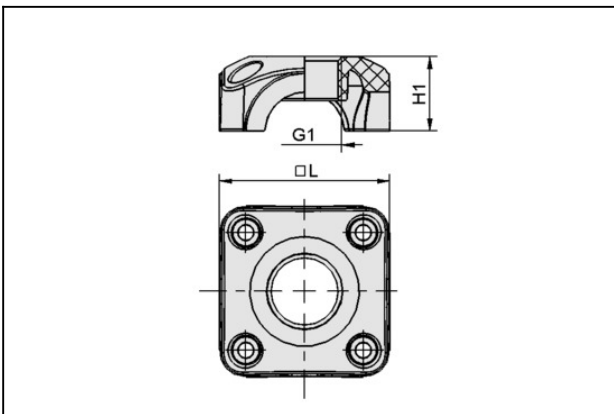

Attribute	Value
G1	G1/8"-F
H1	16.8 mm
L	38 mm