

vacuum area gripper

SBX-C 1040x200 35 O10010S05 SGBL

Part no.:10.01.20.01002

<https://www.schmalz.com/10.01.20.01002>

Homepage > Vacuum Technology for Automation > Vacuum Components > Area Gripping Systems and End Effectors > Vacuum Area Gripping System SBX-C > Area Gripping Systems SBX-C without Ejector > SBX-C 1040x200 35 O10010S05 SGBL

Vacuum area gripping system with integrated vacuum reservoir



Width B: 200 mm
 Length L: 1040 mm
 Cell Distance: 35 mm
 Material-Type:
 Foam 0+S, Height 10+10+5mm
 Fitting version:
 hose connector strai. Ø60

Design Data

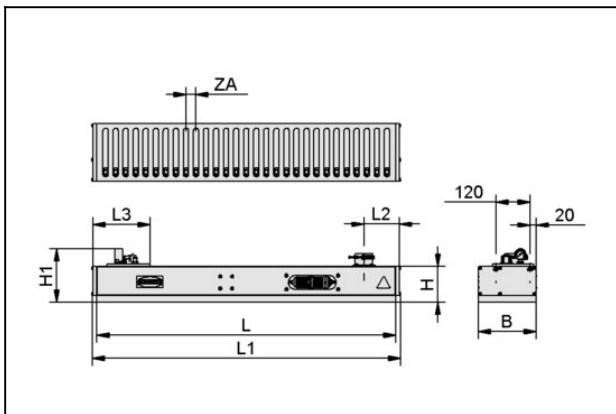

Attribute	Value
B	200 mm
H	125 mm
H1	207.5 mm
L	1,040 mm
L1	1,075 mm
L2	123 mm
L3	198 mm
International	35 mm

Technical Data

Contact to Schmalz

J. Schmalz GmbH | Johannes-Schmalz-Straße, 72293 Glatten, Deutschland | +49 7443 2403-102 | customercenter@schmalz.de

vacuum area gripper

SBX-C 1040x200 35 O10010S05 SGBL

Part no.:10.01.20.01002

<https://www.schmalz.com/10.01.20.01002>

Attribute	Value
Number of suction cells	29
Weight	23 kg

Accessories

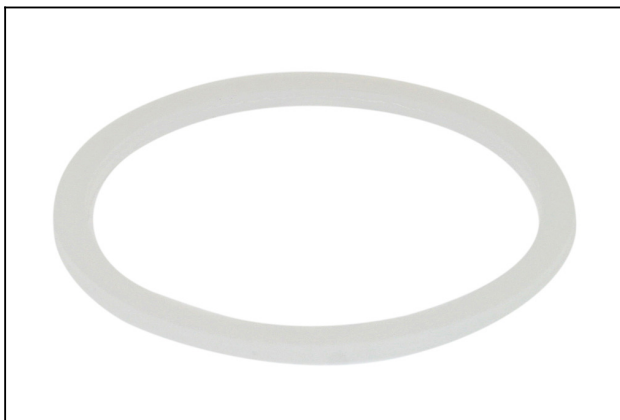

DR G1/4 PA

Part no.10.07.08.00021

Sealing ring

for: G1/4"

External diameter D: 18 mm

Internal diameter d: 13.5 mm

Material: Polyamide



FLK G1/2-IG G1/2-AG

Part no.10.01.03.00175

Flexible suction cup mounting for adaptation to sloping surfaces

Thread G1: G1/2"-F

Thread G2: G1/2"-M

Ambient temperature: 0 ... 70 °C

vacuum area gripper

SBX-C 1040x200 35 O10010S05 SGBL

Part no.:10.01.20.01002

<https://www.schmalz.com/10.01.20.01002>



FLK G1/2-IG G1/2-AG V

Part no.10.01.03.00207

Flexible suction cup mounting for adaptation to sloping surfaces

Thread G1: G1/2"-F

Thread G2: G1/2"-M

Shape: Reinforced

Ambient temperature: 0 ... 70 °C

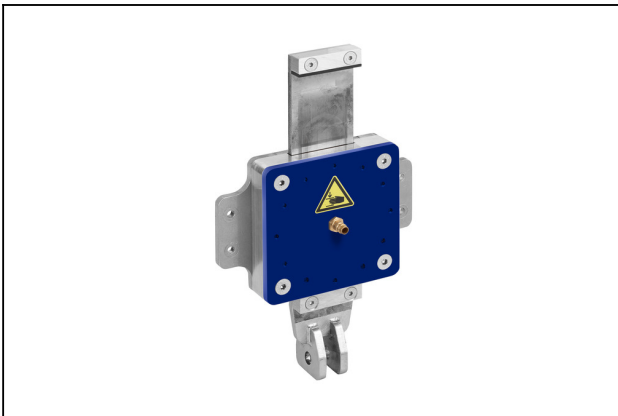

FST-C 100-HD1

Part no.10.01.20.01260

Suspension with height compensation and pneumat. clamping heavy-duty

Shape: Heavy Duty 1 sp. plug

Spring stroke Z: 100 mm

Weight: 9 kg



FST-FLEX 25 HD2 G1/2-AG G3/8-IG

Part no.10.01.10.05695

Spring plunger with both-way damping and height compensation, heavy-duty

Spring stroke Z: 25 mm

Shape: Heavy Duty 2 sp. plug

for: Mounting section

vacuum area gripper

SBX-C 1040x200 35 O10010S05 SGBL

Part no.:10.01.20.01002

<https://www.schmalz.com/10.01.20.01002>



FST-FLEX 50 HD2 G1/2-AG G3/8-IG

Part no.10.01.10.05168

Spring plunger with both-way damping and height compensation, heavy-duty

Spring stroke Z: 50 mm

Shape: Heavy Duty 2 sp. plug
for: Mounting section

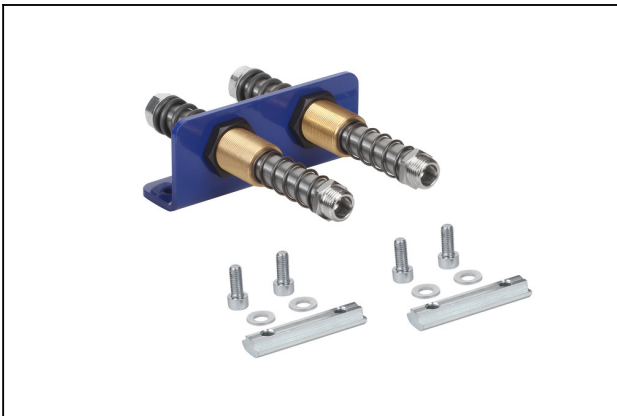

FST-STARR 25 HD2 G1/2-AG G3/8-IG

Part no.10.01.10.05806

Spring plunger with both-way damping and height compensation, heavy-duty

Spring stroke Z: 25 mm

Shape: Heavy Duty 2 spr. plunger
for: Mounting section

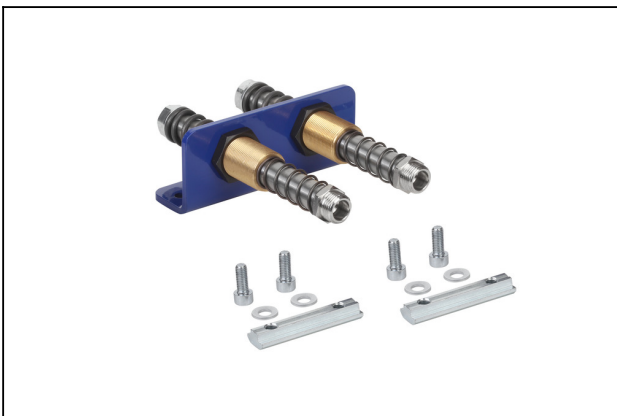

FST-STARR 50 HD2 G1/2-AG G3/8-IG

Part no.10.01.10.05805

Spring plunger with both-way damping and height compensation, heavy-duty

Spring stroke Z: 50 mm

Shape: Heavy Duty 2 spr. plunger
for: Mounting section

vacuum area gripper

SBX-C 1040x200 35 O10010S05 SGBL

Part no.:10.01.20.01002

<https://www.schmalz.com/10.01.20.01002>



FST-STARR 75 HD2 G1/2-AG G3/8-IG

Part no.10.01.10.05803

Spring plunger with both-way damping and height compensation, heavy-duty

Spring stroke Z: 75 mm

Shape: Heavy Duty 2 spr. plunger
for: Mounting section

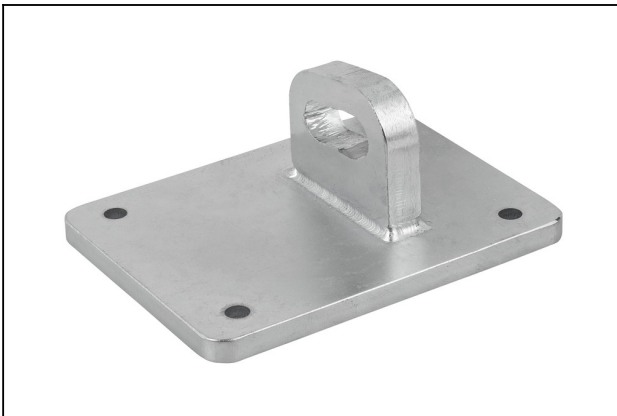

MOD-FLAN 157x120x60 SBX-C

Part no.10.01.20.01275

Flange module

Length L: 157 mm

Width B: 120 mm

Height H: 60 mm

for: Large-area vacuum gripper-C

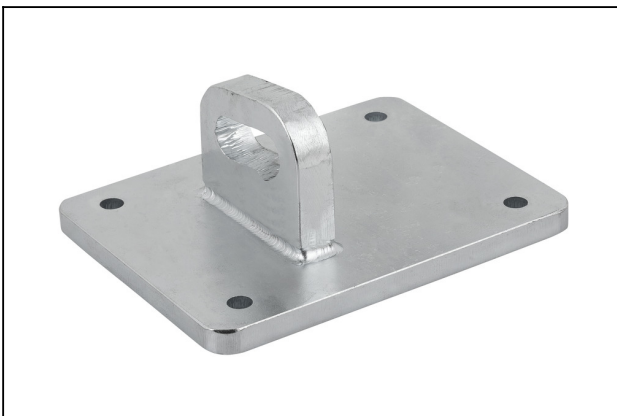

MOD-FLAN 157x120x60 SBX-C

Part no.10.01.20.01274

Flange module

Length L: 157 mm

Width B: 120 mm

Height H: 60 mm

for: Large-area vacuum gripper-C

vacuum area gripper

SBX-C 1040x200 35 O10010S05 SGBL

Part no.:10.01.20.01002

<https://www.schmalz.com/10.01.20.01002>



RED-STK G1/4-AG G1/8-IG MS-V

Part no.10.08.04.00091

Reduction piece with hexagon

Thread G1: G1/4"-M

Thread G2: G1/8"-F

Length L: 4 mm

Material: Brass

Surface: nickel plated



VAM 40 V U

Part no.10.07.02.00046

Vacuum gauge (manometer) for analogue measurement and monitoring of the vacuum

External diameter D: 40 mm

Measuring range: -1.00 ... 0.00 bar

Shape: Connection at bottom

Vacuum connection: G1/8"-M