



EN

Operating Instructions VSi-.../VSi-...-D vacuum/pressure switch

Note

These operating instructions were originally written in German and have been translated into English. Store in a safe place for future reference.

We reserve the right to make technical changes. No responsibility is taken for printing or other types of errors.

Published by

© J. Schmalz GmbH, 08.2016

This document is protected by copyright. J. Schmalz GmbH retains the rights established thereby. Reproduction of the contents, in full or in part, is only permitted within the limits of the legal provisions of copyright law. Any modifications to or abridgments of the document are prohibited without explicit written agreement from J. Schmalz GmbH.

Contact

J. Schmalz GmbH
Aacher Strasse 29
72293 Glatten, Germany

Tel. +49 (0) 7443 2403-0
Fax +49 (0) 7443 2403-259
schmalz@schmalz.de
www.schmalz.com

Contact information for Schmalz companies and trade partners worldwide can be found at
 www.schmalz.com/salesnetwork

1	Safety Instructions.....	5
1.1	Classification of safety instructions	5
1.2	Warnings	6
1.3	Mandatory symbols	6
1.4	General safety instructions.....	7
1.5	Intended use.....	8
1.6	Requirement for the user.....	8
2	Product Description.....	9
2.1	General description	9
2.2	Versions.....	9
2.3	VSi design (without display)	10
2.4	VSi design ... D (with display).....	10
3	Technical Data	11
3.1	General data.....	11
3.2	Electrical data	11
3.3	Mechanical data	12
3.4	Factory settings	12
4	Installation and commissioning	13
4.1	Assembly.....	13
4.2	Electrical connection	13
4.2.1	Pin assignment, M8 connector /M12 connector	15
4.3	IO-Link commissioning	15
5	Interfaces	16
5.1	Digital switching outputs (SIO)	16
5.2	IO-Link	16
5.2.1	Configuration server	17
5.3	NFC	17
6	Manual operation of the display version.....	18
6.1	Operating concept	18
6.1.1	Display of vacuum and pressure values	18
6.1.2	Navigating in the menu.....	19
6.1.3	Editing the parameters	19
6.1.4	Entering the PIN code	21
6.1.5	Automatically quitting the menu	21
6.2	Basic menu.....	22
6.3	Additional functions (AF)	23
6.4	Info (INF)	24
6.5	Displaying the basic settings (slide show).....	25

7	Function description	26
7.1	Overview.....	26
7.2	Measurement of pressure and/or vacuum	27
7.3	Monitoring the operating voltage	27
7.4	Switching points.....	27
7.4.1	Switching point mode and switching point logic	27
7.4.2	Two-point mode.....	29
7.4.3	Window mode.....	29
7.4.4	Condition monitoring mode (leakage measurement)	30
7.4.5	Diagnostics mode	30
7.5	Teach-in for switching points.....	31
7.6	Additional switching point settings	31
7.6.1	Switch-on and switch-off delay.....	31
7.6.2	Transistor function.....	31
7.7	Display screen	32
7.7.1	Display unit.....	32
7.7.2	Display alignment	32
7.7.3	Eco mode	32
7.8	Access rights	33
7.8.1	Write protection for the menu using a PIN code	33
7.8.2	PIN code for NFC write protection.....	33
7.8.3	IO-Link Device Access Locks.....	33
7.8.4	Extended Device Access Locks	34
7.9	Device identification	34
7.9.1	Device identity	34
7.9.2	User-specific localization	35
7.10	System monitoring and diagnostics	35
7.10.1	Minimum and maximum values.....	35
7.10.2	Counters.....	35
7.10.3	Status signals	36
7.10.4	Leakage measurement.....	36
7.11	System commands.....	36
7.11.1	Resetting to factory settings.....	36
7.11.2	Zero-point adjustment of the sensor (calibration).....	36
8	Troubleshooting	37
8.1	List of error numbers	38
9	Maintenance and cleaning	39
9.1	Cleaning the switch	39
9.2	Decommissioning	39
10	Accessories.....	40
11	Warranty	41
12	Conformity Declaration.....	42

1 Safety Instructions

1.1 Classification of safety instructions

Danger

This warning informs the user of a risk that will result in death or serious injury if it is not avoided.

 DANGER	
	<p>Type and source of danger</p> <p>Consequence</p> <p>▶ Remedial action</p>

Warning

This warning informs the user of a risk that could result in death or serious injury if it is not avoided.

 WARNING	
	<p>Type and source of danger</p> <p>Consequence</p> <p>▶ Remedial action</p>

Caution

This warning informs the user of a risk that could result in injury if it is not avoided.

 CAUTION	
	<p>Type and source of danger</p> <p>Consequence</p> <p>▶ Remedial action</p>

Attention

This warning informs the user of a risk that could result in damage to property if it is not avoided.

CAUTION	
	<p>Type and source of danger</p> <p>Consequence</p> <p>▶ Remedial action</p>







General notes

This symbol is used when important notes and information regarding the use of the machine/the system/the device are provided.

	Note/Information
---	------------------





1.2 Warnings

Explanation of the warning symbols used in the operating instructions.



Warning symbol	Description	Warning symbol	Description
	General warning symbol		Warning of hearing damage
	Vacuum warning		Warning of overpressure
	Warning of environmental damage		Explosive atmosphere warning





1.3 Mandatory symbols

Explanation of the mandatory symbols used in the operating instructions.

Mandatory symbols	Description	Mandatory symbol	Description
	Adhere to the operating instructions		Wear eye protection
	Wear ear protectors		Activate prior to maintenance or repair

1.4 General safety instructions

 WARNING	
	<p>Ignoring the general safety guidelines Personal injury / damage to plants / systems</p> <ul style="list-style-type: none"> ▶ The operating instructions contain important information about using the switches. Read the operating instructions thoroughly and keep them for later reference. ▶ The system may only be connected and operations started once the operating instructions have been read and understood. ▶ Use only the connections, mounting holes and attachment materials that have been provided ▶ Carry out mounting or removal only when the device is in an idle and unpressurized state. ▶ Installation may only be carried out by qualified specialist personnel, mechanics and electricians. Qualified specialist personnel are persons who have the knowledge and experience – including knowledge of applicable regulations – necessary to enable them to recognize possible dangers and implement the appropriate safety measures while performing the tasks assigned to them! The same applies to maintenance! ▶ General safety regulations, European standards and VDE guidelines must be observed and complied with! ▶ No modifications may be made to the switch! ▶ Protect the switch from damage at all times!

 CAUTION	
   	<p>Pressure can cause closed devices to explode A vacuum can cause closed devices to implode Damage from flying or aspirated parts</p> <ul style="list-style-type: none"> ▶ Wear protective glasses ▶ Wear ear protectors

CAUTION	
	<p>Inappropriate voltage supply Destruction of switch</p> <ul style="list-style-type: none"> ▶ Only operate the switch using power supply units with protected extra-low voltage (PELV) ▶ The system must incorporate safe electrical cut-off of the power supply in compliance with EN60204 ▶ Do not connect or disconnect the plug connectors when voltage is applied

1.5 Intended use

The VSi-... / VSi-...-D vacuum/pressure switch is to be used only to measure vacuum and pressure. For further information, see the technical data.

Any other use is considered improper by the manufacturer and is deemed as contrary to the designated use.

The switch is only to be operated by trained personnel

Individuals who are not able to operate the system safely due to physical, psychological or sensory problems must not operate the system or may only do so under the supervision of a responsible person.

Intended use includes correct and full compliance with all information provided in the manual, in particular the safety information and the warning notices as well as all associated documentation.

1.6 Requirement for the user

All personnel working with the product must be familiar with basic mechanical, electrical and pneumatic principles as well as the appropriate technical terminology.

To ensure safe operation, this work may only be performed by qualified personnel or trained persons working under the supervision of qualified personnel.

"A qualified employee is defined as an employee who has received technical training and has the knowledge and experience – including knowledge of applicable regulations – necessary to enable him or her to recognize possible dangers and implement the appropriate safety measures while performing tasks. Qualified personnel must observe the pertinent industry-specific rules and regulations."

2 Product Description

2.1 General description



The versions of the vacuum switch and pressure switch in the VSi series are referred to only as the switch below.

The VSi-series switch can be operated in two operating modes. Users can choose between direct connection to discrete inputs (standard I/O = SIO mode) or connection through the communication line (IO link Class A).

Switching points are indicated using one or two orange LEDs. If the switching point is not active, the operational readiness is indicated by a green LED.

Additionally, a multitude of information and status reports for the switch can be accessed using wireless communication with NFC (Near Field Communication).

The parameters can also be set using two buttons on the display version (VSi-...-D). The current system status and the settings are shown on a display.

The fluid connection offers the opportunity to align the switch in a screwed-in position.

2.2 Versions

Each switch has a precise item designation (e.g. VSi P 10 D M8-4) that is composed of the following type keys:

Type	Pressure range	Display	Electrical connection
VSi	V (-1 to 0 bar)	D (with integrated display)	M12-4 (1xM12, 4-pin)
	VP8 (-1 to +8 bar)		M8-4 (1xM8, 4-pin)
	P10 (0 to +10 bar)		

2.3 VSi design (without display)

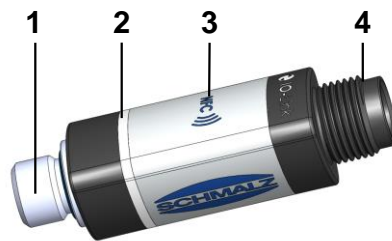

Item	Description
1	Fluid connection
2	Switching point 1 display, ORANGE or operating voltage display, GREEN
3	Position of the NFC antenna
4	Electrical connection M12-4 or M8-4

2.4 VSi design ... D (with display)

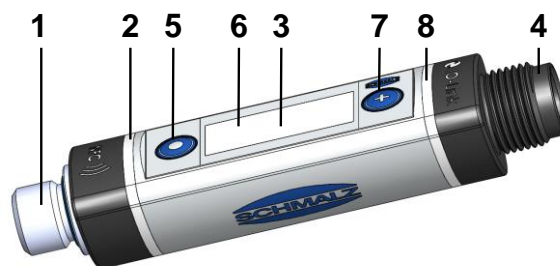

Item	Description
1	Fluid connection
2	Switching point 1 display, ORANGE or operating voltage display, GREEN
3	Position of the NFC antenna behind the display
4	Electrical connection M12-4 or M8-4
5	MODE button
6	Display
7	SET button
8	Switching point 2 display, ORANGE

3 Technical Data

3.1 General data

Measuring medium	Non-aggressive gases; dry, oil-free air	
Operating pressure range	V	-1 to 0 bar
	P10	0 to 10 bar
	VP8	-1 to 8 bar
Overpressure resistance	V	8 bar
	P10	15 bar
	VP8	12 bar
Accuracy	± 3% FS ¹⁾	
Resolution	V	1 mbar
	P10	11 mbar
	VP8	Vacuum 2 mbar/pressure 11 mbar
Degree of protection	IP 65 (M8/M12 plugged in)	
Working temperature	0 to 50 °C	
Storage temperature	-10 to 60 °C	
Permitted humidity	10 to 90% RH (free from condensation)	
Materials used	Housing PA12	
	Fluid connection Stainless steel	
	Seals NBR	
Weight	VSi	12 g
	VSi ... D	16 g

¹⁾ The accuracy applies to the entire measuring and temperature range.

3.2 Electrical data

Supply voltage	DC 10 to 30 V (PELV) ²⁾	
Power consumption (where U = 24 V)	VSi	< 35 mA
	VSi ... D	< 35 mA
Current load rating per output	100 mA	
Polarity reversal protection	Yes, all connections	
Overload/short circuit OUT1/OUT2	Automatic switch-off of both outputs	
NFC	NFC Forum Tag type 4	
IO link	IO link 1.1 Class A	
	Baud rate COM2 (38.4 kBits/s)	
	Minimum cycle time 2.3 ms	
	(also see separate data dictionary)	
Display (only VSi...D)	3-digit, 7-segment display with decimal point	
Display resolution (only VSi...D)	Vacuum	1 mbar
	Pressure	10 mbar

²⁾ The power supply must correspond to the regulations in accordance with EN60204 (protected extra-low voltage).

3.3 Mechanical data

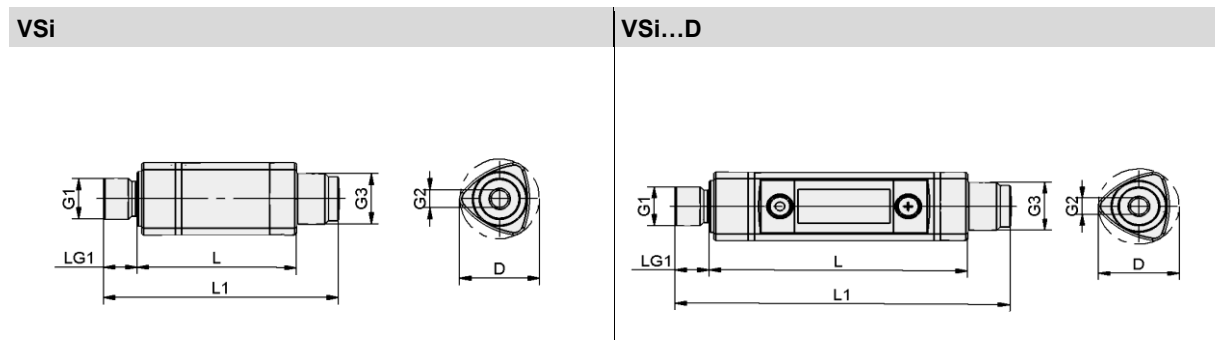

Type	Dimensions in mm						
	D	G1 ¹⁾	G2 ¹⁾	G3	L	LG1	L1
VSi ... M8-4	19.6	G1/8" male thread	M5 female thread	M8x1 male thread	38.0	8	55.0
VSi ... M12-4	19.6	G1/8" male thread	M5 female thread	M12x1 male thread	38.0	8	56.0
VSi ... D M8-4	19.6	G1/8" male thread	M5 female thread	M8x1 male thread	60.5	8	77.5
VSi ... D M12-4	19.6	G1/8" male thread	M5 female thread	M12x1 male thread	60.5	8	78.5



¹⁾ Maximum tightening torque 2.5 Nm

3.4 Factory settings

Parameter	VSi-V	VSi-P10	VSi-VP8
Switching point 1			
Switching point mode and logic	Two-point mode, normally closed (H. no)		
Switching point SP1	750 mbar	5500 mbar	-750 mbar
Reset point rP1	600 mbar	5000 mbar	-600 mbar
Window hysteresis Hy1/leakage limit per sec L-1	20 mbar	100 mbar	20 mbar
Switch-on delay dS1, switch-off delay dr1	0 ms	0 ms	0 ms
Switching point 2			
Switching point mode and logic	Two-point mode, normally closed (H. no)		
Switching point SP2	550 mbar	5000 mbar	5500 mbar
Reset point rP2	500 mbar	4500 mbar	5000 mbar
Window hysteresis Hy2/leakage limit per sec L-2	20 mbar	100 mbar	20 mbar
Switch-on delay dS2, switch-off delay dr2	0 ms	0 ms	0 ms
Transistor function			
Transistor function	PNP	PNP	PNP
Display unit			
Display unit	mbar	mbar	mbar
Eco mode			
Eco mode	Off	Off	Off
Display alignment			
Display alignment	Standard	Standard	Standard
IO link device locks, extended device locks			
IO link device locks, extended device locks	0	0	0
Menu PIN code, NFC PIN code			
Menu PIN code, NFC PIN code	000	000	000

4 Installation and commissioning







4.1 Assembly



VSi		VSi...D	
			
Item	Description	Max. tightening torque	
1	Fluid connection	2.5 Nm	
4	Electrical connection	-	
9	Screw-in aid (see accessories)		









To install the switch on the fluid connection, screw it in with a maximum of 2.5 Nm. The screwed-in switch can be turned back slightly to align it.

4.2 Electrical connection

 DANGER	
	<p>Moving systems/parts throughout the production facility during set-up at the workplace</p> <p>Death or very serious injury/material damage</p> <ul style="list-style-type: none"> ▶ Do not enter the danger zone when the system is operational.
 DANGER	
	<p>Risk of fire and explosion</p> <p>Death or very serious injury</p> <ul style="list-style-type: none"> ▶ The switch must not be used in environments where there is a risk of explosion.
 CAUTION	
	<p>The output signals can change when the power supply is switched on or a plug connector is plugged in.</p> <p>Serious personal injury and/or damage to property</p> <ul style="list-style-type: none"> ▶ The electrical connection must only be carried out by individuals who are able to assess the impact of signal changes on the overall machine / facility / system.

 CAUTION	
 	<p>Noise pollution due to incorrect installation of the media connection</p> <p>Hearing impairments may occur in the longer term</p> <ul style="list-style-type: none"> ▶ Correct installation ▶ Wear ear protectors

 CAUTION	
   	<p>Pressure can cause closed devices to explode</p> <p>A vacuum can cause closed devices to implode</p> <p>Damage from flying or aspirated parts</p> <ul style="list-style-type: none"> ▶ Wear protective glasses ▶ Wear ear protectors

CAUTION	
	<p>Inappropriate voltage supply</p> <p>Destruction of switch</p> <ul style="list-style-type: none"> ▶ Only operate the switch using power supply units with protected extra-low voltage (PELV) ▶ The system must incorporate safe electrical cut-off of the power supply in compliance with ▶ Do not connect or disconnect the plug connectors when voltage is applied

The electrical connection of the switch is made using a 4-pin M-12 or a 4 pin M-8 connector.

	<p>The maximum cable length is 30 m in SIO operation and 20 m in IO-link operation.</p>
---	---

CAUTION	
	<p>Incorrect connection on IO-Link Class B Port.</p> <p>Poss. damage to the IO- Link Master or periphery</p> <ul style="list-style-type: none"> ▶ When operating the IO-Link Class A switch with an IO- Link Master with Class B Port ensure compliant connection and isolation

4.2.1 Pin assignment, M8 connector /M12 connector

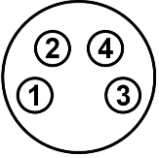
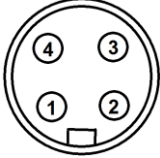
M8 connector	M12 connector	Pin	Symbol	Wire color ¹⁾	Function
		1	U _s	Brown	Supply voltage
		2	OUT2	White	Signal output 2 (SIO)
		3	Gnd	Blue	Ground
		4	OUT1	Black	C/Q (IO link) or signal output 1 (SIO)

¹⁾ when using a Schmalz connection line (see accessories)

4.3 IO-Link commissioning

When operating the switch in IO-link mode (digital communication), the supply voltage, Gnd and the C/Q communication cable must be directly connected with the corresponding connectors of an IO-Link master with Ports IO-Link Class A. When doing so, a new port must be used for each switch; a junction of several C/Q cables is not possible with only one IO-Link master port.

The IO-Link master must be connected in the configuration of the automation system in the same way as other fieldbus components. To activate the port for IO-link communication, a software tool from the respective master manufacturer is usually provided (e.g. Siemens PCT Beckhoff TwinCAT, etc.). The necessary device description data (IODD) for the switch can be downloaded from our website www.schmalz.com.



The second output OUT2 for the switch is deactivated in IO-link operation.

5 Interfaces

5.1 Digital switching outputs (SIO)

To operate the standard digital inputs of the automation technology or to directly control the electrical consumers, the switch has two digital outputs.

The electrical status of both of the outputs OUT1 and OUT2 thus corresponds with the logical status of switching points 1 and 2 regardless of the switching point parameters that have been set:

- Switching point mode and switching point logic
- Switching thresholds and hysteresis (function depends on mode set)
- Switch-on and switch-off delay times
- Electrical transistor functions PNP or NPN

5.2 IO-Link

The switch provides many additional functions besides both switch signals via the IO-link communication.

- The actual measurement value is provided live using the process data
- Warnings and error statuses that occur are reported to the master via the IO-link event mechanism.
- More precise information regarding the system status is retrieved using the acyclical communication channel (so-called ISDU parameters).
- Within the framework of the ISDU channel, all settings (e.g. switching point modes and delay times) for the switch are read or overwritten.
- In addition to the identification data that can be accessed from the control menu such as the part number and serial number, additional information regarding the identity of the switch can be retrieved.

The switch also provides memory for user-specific information, which means that, for example, it is possible to save an installation or storage site.

The following diagram shows the alignment of the 2 byte process input data for the switch.

PD in byte no.	0								1							
Bit no.	15	14	13	12	11	10	9	8	7	6	5	4	3	2	1	0
Contents	Measured value (14 bit)														SP2	SP1

The SP1 and SP2 bits reflect the logical status of switching points 1 and 2.

Depending on the version, the measurement value is displayed as follows:

- VSi V: 14 bit unsigned vacuum in millibar (vacuum positive)
- VSi P10: 14 bit unsigned pressure in millibar (pressure positive)
- VSi VP8: 14 bit signed pressure in millibar (pressure positive, vacuum negative)

A detailed description of all device parameters can be found in the data dictionary for the switch, which can be downloaded together with the IODD as a ZIP archive from www.schmalz.com.

5.2.1 Configuration server

Since revision 1.1, the IO-Link protocol has contained an automated process for transferring data when a device is replaced. For this data storage mechanism, the IO-Link master mirrors all setting parameters for the device in a separate non-volatile memory. When a device is swapped for a new one of the same type, the setting parameters for the old device are automatically saved in the new device by the master.

In order for this to work with the switch, it must be operated on a master with IO-Link revision 1.1 or higher and the data storage feature must be activated in the configuration of the IO-Link port.

A detailed description of the data storage mechanism cannot be provided here; however, note the following practical information:

- To ensure that data is transferred in the correct direction when a device is replaced, it must be ensured that the new device is restored to the factory settings before it is connected to the IO-Link master.
This can be done at any time using the function for restoring the factory settings, for example, via the operating menu.
- The device parameters are automatically mirrored in the master when the device is configured using an IO-Link configuration tool such as S7-PCT.
- Changes to the parameters made in the user menu on the device or via NFC are automatically mirrored in the master.
- Changes to the parameters made by a PLC program using a function module are not automatically mirrored in the master.
In this case, mirroring can be triggered manually by executing ISDU write access to the "System Command" parameter (index 2) with the "ParamDownloadStore" command (numerical value 5) once all the required parameters have been changed.

5.3 NFC

NFC (Near Field Communication) refers to a standard for wireless data transfer between different devices over short distances.

The switch functions as a passive NFC tag which can be read by a reader, e.g. smart phone or tablet. With the NFC applications by Schmalz, the information is displayed using a mobile website in the browser, therefore an app is not required. The smartphone must only have NFC activated and be connected to the internet.

Since the reading distance is very short, as is the case with other NFC applications, you should find out about the position of the NFC antenna in the smartphone or tablet used. The following instructions should be observed for an optimum data connection between the NFC reading device and VSi:

- In the VSi version, the antenna is located behind the NFC label on the housing
- In the VSi...D display version, the antenna is located directly behind the display
- The mobile device itself must be aligned as parallel as possible to the front of the switch
- The antenna of the mobile device should be positioned in the center of the antenna of the switch

The NFC functionality is supported by many current smartphones. At the time of creating this document, the situation with regard to Apple devices was that the NFC communication was not yet available for general use such as for use by the Schmalz vacuum/pressure switch.



When parameters of the switch have to be changed via the IO-link or NFC, it must be ensured that the power supply of the switch then remains stable for at least three seconds. Otherwise, it can result in data loss and the subsequent error E01.



Access to the switch's parameters via NFC also works without a connected supply voltage.

6 Manual operation of the display version

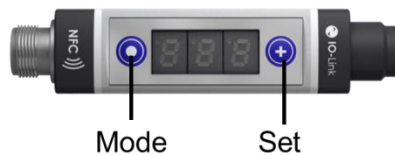

The switch is operated using the mode and set buttons. Settings are made using software menus. The operating concept is set up according to VDMA 24574-1 and is divided into three menu levels:

- Basic menu
- Menu for additional functions (AF)
- Info menu (INF)

Setting of the switch in the basic menu is sufficient for standard applications.

The display shows all of the information, including:

- Actual vacuum/pressure measurement value
- Selected menu item
- Settings
- Error messages



When switch parameters have to be changed in the operating menu, it must be ensured that the power supply of the switch then remains stable for at least three seconds. Otherwise it can result in data loss and the subsequent error E01.

6.1 Operating concept

6.1.1 Display of vacuum and pressure values

In the basic operating menu state, the actual measurement value is displayed on the basis of the chosen display unit. All units are available in millibar, kilo pascal, inch-hg and PSI.

The information displayed varies depending on the device version and the position of the measurement value in the vacuum and pressure range:

Measureme	Version V				Version P10				Version VP8			
	mbar	kPa	inHg	psi	bar	kPa	inHg	psi	bar mbar	kPa	inHg	psi
10 bar	FFF	FFF	FFF	FFF	FFF	FFF	FFF	FFF	FFF	FFF	FFF	FFF
9 bar	FFF	FFF	FFF	FFF	9.00	900	266	131	FFF	FFF	FFF	FFF
8 bar	FFF	FFF	FFF	FFF	8.00	800	236	116	8.00	800	236	116
6 bar	FFF	FFF	FFF	FFF	6.00	600	177	87	6.00	600	177	87
- 800 mbar	800	80.0	23.6	11.6	-FF	-FF	-FF	-FF	800	80.0	23.6	11.6
- 1000 mbar	-FF	-FF	-FF	-FF	-FF	-FF	-FF	-FF	-FF	-FF	-FF	-FF

With version V, the vacuum value, i.e. the vacuum compared to the ambient air pressure, is displayed as a positive; in version P10, it is displayed based on the pressure.

In version V8, the pressure is positive and vacuum is negative; however, the positive/negative sign is not displayed. You can determine whether the value is positive or negative using the table due to the presence of a decimal point.

The switching threshold SPx/FHx and rPx/FLx in the operating menu is displayed based on the same method.

If an error status is active, it is indicated in the display through a periodic switch with the measurement value. For recognition purposes, a prefix “E” stands for error, followed by the error number (see list in [chapter 8.1](#)).

One exception is error 7 (operating voltage too low): in this case “E07” will be permanently indicated in the display and the switch will delay further user entries until the operating voltage has reached the necessary level again.

6.1.2 Navigating in the menu

The basic menu can be reached from the basic status by pressing the SET button.

To scroll through the menu press the SET button.

When the desired menu item has been found, select it using the MODE button.

If there is a submenu (“AF” and “INF”), this can also be browsed in the same manner using the SET button.

By pressing both buttons at the same time, it is possible to quit the menu at any point.

6.1.3 Editing the parameters

If a menu item has been selected, the current value will firstly appear in the display. With parameters that can be set, the whole value or lowest number will flash and can be changed by using the SET button. When doing so, the possible settings are run through cyclically.

With version VP8, the values of the switching thresholds SPx/FHx and rPx/FLx can be positive (pressure measurement range) as well as negative (vacuum measurement range). In this case, the desired range of the new value is set at the start of the editing process. The text “PrS” for pressure or “UAC” for vacuum will firstly flash and can be selected accordingly.

For numerical values that consist of three numbers, the MODE button can be changed for the next higher number.

At the end of the editing process, the MODE button is pressed again after the last number. The new value then appears for two seconds in the display without flashing.

If the new value is invalid, the display will instead receive a message and the old value is retained:

- „Oor“ (out of range) means that the new value is generally out of range, for example, SP1 > 8.0 bar in the variant VP8
- „InC“ (inconsistent) means that the value collides with the current setting of another parameter, e.g. rP1 > SP1

To cancel the editing process, both buttons can be simultaneously pressed at any time.

The following table illustrates the editing with four examples:

Setting the numerical		Changing SP1 from 750 mbar to 725 bar with V version	
SP1	→ 7 5 0		Choose menu item, lowest number flashes
	↓ 7 5 5	+	SET button pressed 5 times
	↓ 7 5 5	○	MODE button pressed, middle number flashes
	↓ 7 2 5	+	SET button pressed 7 times
	↓ 7 2 5	○	MODE button pressed, highest number flashes
	↓ 7 2 5	○	MODE button pressed, new value confirmed
SP1	←		Automatically returns to the menu title after 2 seconds
Setting the numerical		Changing SP1 from -750 mbar to +3.2 bar with VP8 version	
SP1	→ 7 5 0		Choose menu item, lowest number flashes
	↓ U A C	+	SET button pressed once, preselection of the measurement value range
	↓ P r S	+	SET button pressed once, switch to pressure value range
	↓ 0 . 0 0	○	MODE button pressed, value range confirmed, lowest number flashes
	↓ 0 . 0 0	○	MODE button pressed, middle number flashes
	↓ 0 . 2 0	+	SET button pressed 2 times,
	↓ 0 . 2 0	○	MODE button pressed, highest number flashes
	↓ 3 . 2 0	+	SET button pressed 3 times
	↓ 3 . 2 0	○	MODE button pressed, new value confirmed
SP1	←		Automatically returns to the menu title after 2 seconds
Setting the mode		Changing switching point mode 1 from H.no to C.no	
Ou1	→ H.no		Choose menu point, current number flashes
	↓ C.no	+	SET button pressed 4 times
	↓ C.no	○	MODE button pressed, new value confirmed
Ou1	←		Automatically returns to the menu title after 2 seconds
Canceling a command		Resetting the erasable counters	
rct	→ No		Preselect command execution "no"
	↓ Yes	+	SET button pressed 1 times, command execution "yes"
	↓ rct	○	MODE button pressed, command is executed
Measurement value: 0	←		After 2 seconds, the menu is exited (back to basic status)



Write accesses from the IO-link and NFC interfaces have a higher priority than the operating menu, but generally last only a few seconds. However, if editing is attempted at the same time using the menu, this will be rejected with the display "LoC."

6.1.4 Entering the PIN code

If the menu was write protected with a PIN code, this must be entered first before a parameter can be changed. If you attempt to change a value, the message "P.I.n" will appear in the display and changes after two seconds to enter the 3-digit PIN code. This will be entered number by number like any other numerical value and confirmed with the MODE button.

When entering a valid PIN the message "UnC" appears and any number of parameters can then be changed. It is also possible to quit the menu in the meantime. If no button has been pressed for one minute or the switch was switched on or off, write protection is activated again.

The entry of an invalid PIN is rejected with the message "LoC."

6.1.5 Automatically quitting the menu

The menu will automatically close if no button is pressed for one minute.



The display also returns to the basic status when an error status occurs so that the error number can be displayed. The menu can be called up and used again afterward.

If parameters are changed using one of the other interfaces, i.e. via the IO-link or NFC, the menu will also close. The instruction "dAt" will then appear for two seconds.

6.2 Basic menu



























All of the settings for standard switch applications can be configured and read from the basic menu.

The following menu items are available:

Menu item	Example	Description
Default state		Display of current measured value Periodic switch to error number, if active
	bar SIO SP1 750 rP1 600 US	Automatic display of the basic settings: Unit Communication mode Switching point 1 (mbar) Reset point 1 (mbar) Operating voltage
		Automatic return to default state
SP1/FH1	→ 750	Switching point 1/upper window point 1
		
rP1/FL1	→ 600	Switching point 1/lower window point 1
hy1/L-1	→ 20	Hysteresis switching point 1 (window mode) or leakage limit 1 (CM mode)
SP2/FH2	→ 550	Switching point 2/upper window point 2
rP2/FL2	→ 500	Switching point 2/lower window point 2
hy2/L-2	→ 20	Hysteresis switching point 2 (window mode) or leakage limit 2 (CM mode)
tCH	→ No / SP1 / SP2	Teach-in function
CAL	→ No/yes	Calibrate zero offset
AF	→	Submenu: Additional functions
INF	→	Submenu: Information
		Quitting the menu

6.3 Additional functions (AF)

An extended configuration menu is available for applications with special requirements. The menu item order is as follows:

Menu item	Example	Description
AF		AF menu title in basic menu
 Ou1	 H.no	Switching function, switching output 1: H.no/H.nc: Hysteresis function, normally open/normally closed F.no/ F.nc: Window function, normally open/normally closed C.no/C.nc: Condition monitoring function, normally open/normally closed d.no/ d.nc: Diagnosis function, normally open/normally closed
		
 Ou2	 H.no	Switching function, switching output 2: (see Ou1)
		
dS1	 0	Switch-on delay for switching point 1 in ms
		
dr1	 0	Switch-off delay for switching point 1 in ms
		
dS2	 0	Switch-on delay for switching point 2 in ms
		
dr2	 0	Switch-off delay for switching point 2 in ms
		
uni	 bAr	Display unit: bAr: Millibar/Bar kPa: Kilopascal IHg: Inch Mercury PSI: Pound-force per square inch
		
Eco	 off	Eco mode: off: no eco mode on: Eco mode with display switch-off Lo: Eco mode with dimmed display
		
dIS	 Std	Display alignment: Std (standard)/red (rotated)
		
Pin	 000	Pin code for the menu
		
P-n	 PnP	Transistor functions of both outputs: PnP/nPn
		
rES	 No/yes	Reset to factory settings
		
		Return to menu title

6.4 Info (INF)

The info menu is available for reading out system data such as counters, software version, part numbers and serial numbers. The operating structure is as follows:

Menu item	Example	Description
INF		INF menu title in basic menu
HI	→ 853	Highest measured sensor value (since restart)
LO	→ 0	Lowest measured sensor value (since restart)
rHL	→ No/yes	Reset maximum and minimum values (HI/LO)
Cc1	→ 0.48	Counter, switching ramp SP1 (non-erasable): Display of the 3 highest numbers
	+ ↓ 61.8	Cc1: Display of the 3 middle numbers
	+ ↓ 59.3	Cc1: Display of the 3 lowest numbers
		Subsequent counter status: 48,618,593
	⊙ ↻	Return to info menu
Cc2	→ 0.03	Counter, switching ramp SP2 (non-erasable):
Ct1	→ 0.00	Counter, switching ramp SP1 (erasable):
Ct2	→ 0.00	Counter, switching ramp SP2 (erasable):
rct	→ No/yes	Reset erasable counters (Ct1 and Ct2)
SoC	→ 1.04	Firmware revision
Type	→ 10.	Part number: Display of first two numbers
	+ ↓ 06.0	Part number: Display of next 3 numbers
	+ ↓ 2.00	Part number: Display of next 3 numbers
	+ ↓ 589	Part number: Display of last 3 numbers
	⊙ ↻	Subsequent article number: 10.06.02.00589
Sno.	→ 0.01	Serial number
		Return to menu title

The counters and serial numbers are 9-digit whole numbers. These are divided into three blocks of three numbers when indicated in the display. One of the decimal points will flash to indicate whether it is referring to the highest, middle or lowest block. The display starts with the 3 highest numbers and can be scrolled through using the set button. This is illustrated in the table using the Cc1 counter.

The switch's part number will also be properly distributed into number blocks for the display and can be scrolled through using the set button. The decimal point indicates your position within the 11-digit article number. Part number 10.06.02.00589 is used in the table as an example.

6.5 Displaying the basic settings (slide show)

By pressing the mode button in the basic status, the selected basic settings for the switch are automatically displayed one after the other in the display.

These basic settings are:

- Switching point Sp1
- Reset point rP1
- Operating mode display (SIO or IO link)
- Supply voltage

The display cycle returns to the vacuum display after a complete cycle or can be canceled at any time by pressing any button.



The switch is not a precise voltage meter, but the voltage displayed can still be used as a reference value and for comparative measurements.

7 Function description

7.1 Overview

The following table gives an overview of all the switch's functions.

Description	Availability			Menu title	See chapter
	Menu	IO-	NFC		
Switching point setting	Yes	Yes	Yes	SP1/FH1 rP1/FL1 hy1/L-1 SP2/FH2 rP2/FL2 hy2/L-2	7.4
Switching point mode and logic	Yes	Yes	Yes	Ou1 Ou2	7.4.1
Teach-in	Yes	Yes	Yes	tCH	7.5
Switch-on and switch-off delay	Yes	Yes	Yes	dS1 dr1 dS2 dr2	7.6.1
Transistor function	Yes	Yes	Yes	P-n	7.6.2
Display unit	Yes	Yes	Yes	uni	7.7.1
Display alignment	Yes	Yes	Yes	dIS	7.7.2
Eco mode	Yes	Yes	Yes	Eco	7.7.3
IO-Link Device Access Locks	No	Yes	No		7.8.3
Extended Device Access Locks	No	Yes	No		7.8.4
Menu PIN	Yes	Yes	Yes	Pin	7.8.1
NFC PIN	No	Yes	No		7.8.2
Part number	Yes	Yes	Yes	Type	7.9.1
Software version	Yes	Yes	Yes	SoC	7.9.1
Serial number	Yes	Yes	Yes	Sno.	7.9.1
IO-Link identification data	No	Yes	Yes		7.9.1
User-specific identification	No	Yes	Yes		7.9.2
Voltage measurement	Yes	Yes	Yes		7.3
Minimum and maximum values	Yes	Yes	Yes	HI/LO	7.10.1
Counters	Yes	Yes	Yes	Cc1 Cc2 Ct1 Ct2	7.10.2
Warnings and errors	Yes	Yes	Yes	Exx/FFF/-FF	8
System status	No	Yes	Yes		7.10.3
Condition monitoring	No	Yes	Yes		7.10.4
Reset to factory settings	Yes	Yes	Yes	rES	7.11.1
Calibrating zero position	Yes	Yes	Yes	CAL	7.11.2
Resetting HI/LO	Yes	Yes	Yes	rHL	7.10.1
Resetting meters	Yes	Yes	Yes	rct	7.10.2

7.2 Measurement of pressure and/or vacuum

Depending on the version, the VSi-series switches measure the pressure and/or vacuum relative to the ambient air pressure:

- VSi-V vacuum switch: The vacuum will be indicated as positive pressure difference.
- VSi-P10 pressure switch: The pressure will be indicated as a positive pressure difference.
- VSi-VP8 combined vacuum/pressure switch: Pressure is displayed as positive, vacuum is displayed as negative. The measurement value via IO-link process data is shown as a signed binary number. The sign is indicated by the position of the decimal point on the display (see [chapter 6.1](#) Operating concept)

“FFF” will appear in the display when the pressure is too high. In the case of versions P10 and VP8, an event will also then be sent via IO-link indicating that the measurement value is outside the valid range.

The message “-FF” appears in the display when there is high vacuum and the appropriate IO-link event will be sent in the case of versions V and VP8.

In the IO-link operation, these cases ensure that a fixed numerical value outside the normal measurement range is transmitted instead of a measurement value (see “Special Values” in the data dictionary). These numbers are then not to be interpreted as measurement values but as a notice of an overflow.

7.3 Monitoring the operating voltage

The switch measures the amount of its operating voltage US with a resolution of 100 mV.

When the valid voltage range is left, corresponding error statuses are triggered (see [chapter 8](#)). In the undervoltage range, the switch delays all inputs by the user.



The switch is not a precise voltage meter, but the voltage displayed can still be used as a reference value and for comparative measurements.

7.4 Switching points



In the following, the switching point number is always denoted by an “x” when information applies equally to both switching points. SPx therefore stands for both SP1 and SP2.

7.4.1 Switching point mode and switching point logic

Both switching points are identical in terms of function and can be parameterized independently of one another. There are four different switching point modes to choose from:

- Two-point mode H.no/H.nc
- Window mode F.no/F.nc
- Condition monitoring mode C.no/C.nc
- Diagnostics mode D.no/D.nc

In this case, there is a differentiation between the switching point logic NO (normally open) and NC (normally closed). A change in the switching point logic from NO to NC causes a logical inversion of the electrical switch outputs, the switching point bits in the IO-link process data and the orange LED display(s) on the switch.



The condition monitoring and diagnostics modes cannot be activated simultaneously for both switching points. That means that when a switching point is already parameterized to C.no, C.nc, D.no or D.nc, the other can only adopt the modes H.no, H.nc, F.no or F.nc.



The version P10 is purely a pressure switch and therefore does not offer condition monitoring mode to monitor the vacuum leakage.

With the version VP8 with combined vacuum/pressure measurement range, the switching points react according to the position of their “upper” switching point SPx/FHx as a pressure switch or vacuum switch. Values are considered “bigger” when they are further from zero and as “smaller” when they are closer to zero.

The following diagram shows the switching point behavior using the two-point mode as an example:

Combined Vacuum- and Pressure Switch (VP 8)

Switching output behaviour using the example of the two-point-mode

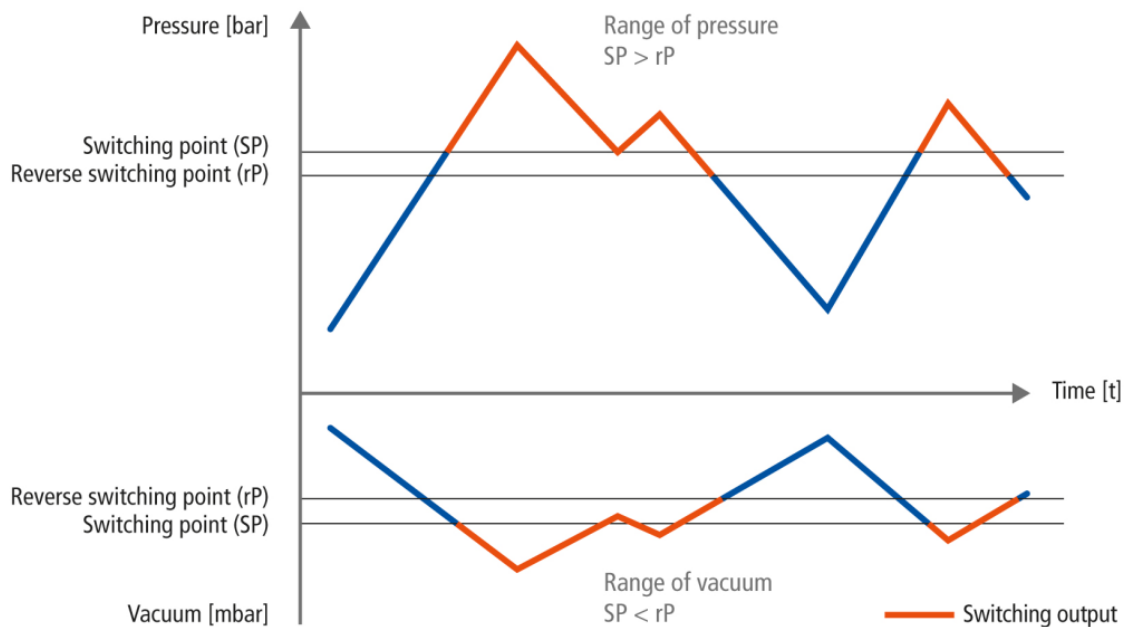

7.4.2 Two-point mode

The two-point mode is a threshold switch with hysteresis. When the measurement value increases, the switching point will be active when the switch-on threshold SP_x is reached and remains on until it falls below the reset threshold rPx .

The following must always apply for switching thresholds and reset thresholds: $|SP_x| > |rPx|$. The hysteresis is therefore defined by the difference $|SP_x - rPx|$.

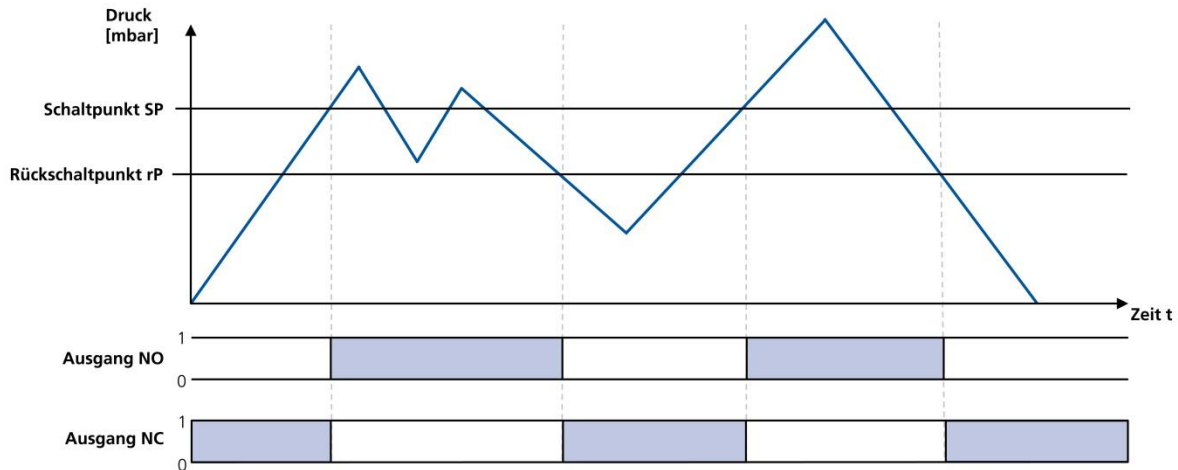

7.4.3 Window mode

In window mode, the switching point is active when the measurement value is between the upper window point FH_x and the lower window point FL_x . Outside this window, the switching point is inactive. If necessary, a common switching hysteresis H_{yx} can be set, which symmetrically applies to both window points.

For the parameters of the upper window point FH_x , lower window point FL_x and hysteresis H_{yx} , the following must always apply: $|FH_x| > |FL_x| + H_{yx}$

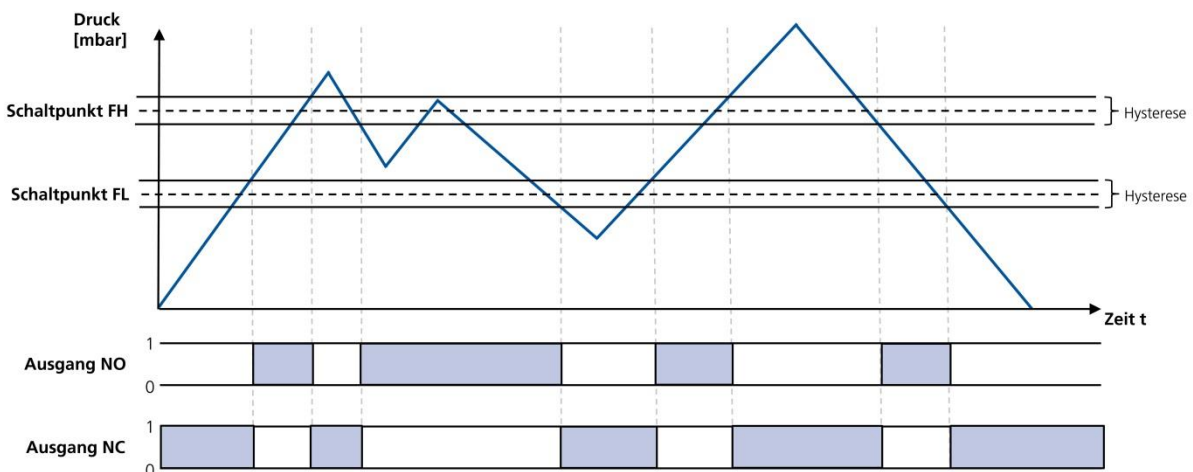

When switching from two-point mode to window mode, the current switching points SP_x and rPx are interpreted as window points FH_x and FL_x . They are the same internal parameters (also see the data dictionary). If the resulting set of parameters are not valid in the new mode (e.g. hysteresis too big in window mode), it is not possible to switch the mode.

7.4.4 Condition monitoring mode (leakage measurement)

The condition monitoring switching point mode can be used to monitor the quality of a vacuum suction system. A requirement for this is that the suction system that is pneumatically connected to the VSi has an air saving function or vacuum control in accordance with the two-point principle (e.g. a suction circuit with Schmalz SCP FS-RP-series ejectors). With such a system, the VSi can measure the vacuum leakage in millibars per second between two drainage cycles. The switching point is then activated when a leakage exceeds its maximum permissible setting, which can be configured. The detection of an external suction cycle is carried out using the configurable threshold values SPx and rPx that here indicate the thresholds for picking up and releasing a tool. The threshold for the maximum permissible leakage is set using the parameter L-x in millibars per second.

The following diagram shows the case of a typical suction cycle where the system indicates a leakage and the vacuum generator drains many times:

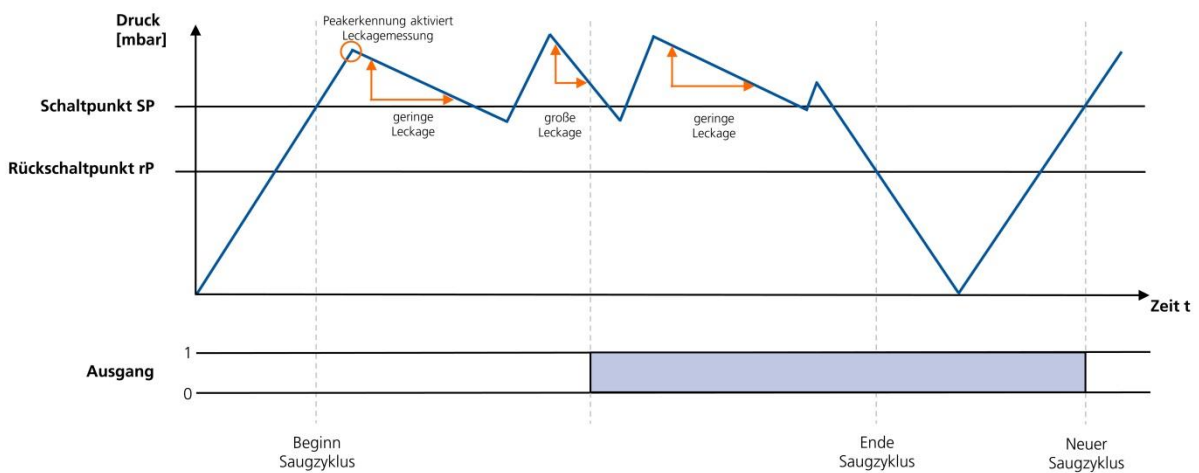

Another application for condition monitoring mode occurs if the regulation threshold of the vacuum system is never achieved and the vacuum generator permanently drains. In this case, if the end vacuum is 20 mbar lower than the start vacuum, the switching point will also be activated.



For a very tight vacuum system where the second case shown always occurs in normal operation and indicates no error, condition monitoring mode is not suitable.



With the VP8 version, the corresponding switching threshold SPx must be in the vacuum range so that condition monitoring mode can be activated.

7.4.5 Diagnostics mode

Diagnostics mode monitors the internal warnings and error messages of the switch. When any error message (error code in display or ISDU 130) or warning (CM bit in ISDI 146) appears, the switching point is activated.

With the V and VP8 versions, diagnostics mode also includes the functionality of the condition monitoring mode at the same time, provided that the associated switching point SPx is in the vacuum range. That means in this case the switching point is also activated when the leakage measurement results in a warning.

7.5 Teach-in for switching points

A teach-in function is available to make it easier to set the switching thresholds. This only affects one switching point on one occasion and changes nothing on the selected switching point mode or switching point logic.

To cancel a teach-in process, the selected switching point must first be pre-selected. This is done via IO-link via ISDU 28 or in the menu item "tCH" in the basic menu. In the menu, the teach-in starts immediately when the MODE button is pressed; if it is done via IO-link, the appropriate system command has to be written via ISDU 2 first.

The switch-on threshold SPx or FHx is set for teach-in in such a way that it is 20% below the actual required measurement value. These specifications for the teach-in in the vacuum range of the VP8 version again refer to the absolute value of the measurement value.

The reset threshold for vacuum values is set 50 mbar below the switch-on threshold, and 300 mbar below it for pressure values. The associated hysteresis for window mode is set at 10 mbar for vacuum values and 100 mbar for pressure values.

For the VSi...D version with a display, an automatic display cycle of the newly set values appears in the display after the successful teach-in process.

7.6 Additional switching point settings

7.6.1 Switch-on and switch-off delay

A delay time can be set for each switching point and each associated switching threshold. This can be used to handle short-term fluctuations in the measurement signal.

In this case, the switch delay dS_x is based on a situation in which the measurement value increases (from the absolute value). Accordingly, the reset delay dR_x is based on a decreasing measurement value.

The following diagram shows the possibility to set the delay times using the two-point mode ($dS/dR \neq 0$):

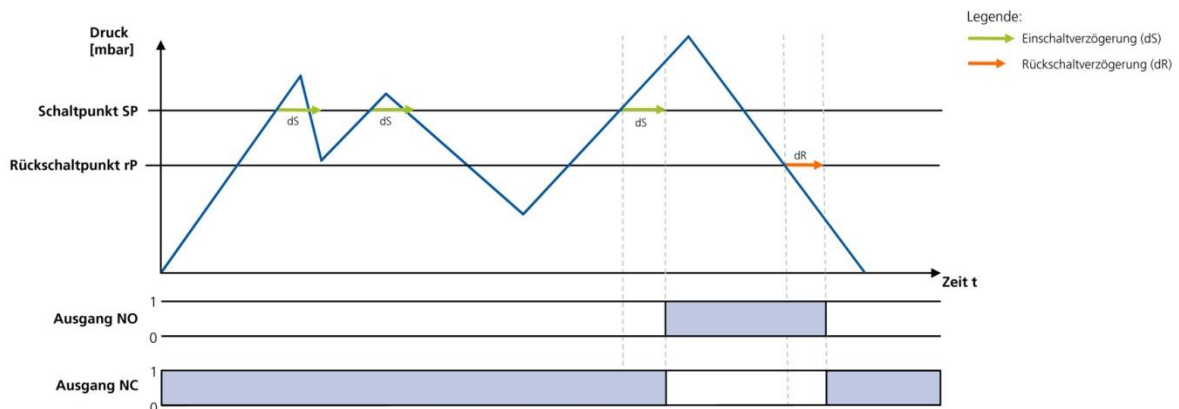

7.6.2 Transistor function

The electrical characteristic of the switch outputs can be switched between PNP switching ("plus switching" or also 24V switching) and NPN switching ("zero switching" or also GND switching). Both switching outputs can always be set together, which does not affect the IO-link operation.

7.7 Display screen

7.7.1 Display unit

The physical unit used to indicate the measurement values and the switching thresholds and hysteresis on the display can be chosen from the following selection:

- mbar/bar (vacuum values in mbar, pressure values in bar)
- kPa
- inch-Hg
- Psi



The setting made here has no effect on the display of values via IO-link and NFC. These are always measured in mbar (see the data dictionary).

7.7.2 Display alignment

The display alignment can be rotated by 180 degrees to adapt to the installation position of the switch. When rotated, the decimal point on the far right is no longer displayed and is therefore missing from the display of the counter statuses and serial numbers.

7.7.3 Eco mode

The switch offers the opportunity to switch off or dim the display in order to reduce power consumption.

- Eco mode “on:” The numerical display will switch off one minute after the last button is pressed.
- Eco mode “lo:” One minute after the last button is pressed, the numerical display will reduce to 50% of its normal brightness.

When a button is pressed or when an error message occurs, the display will be switched on again as normal.



If you activate Eco mode using IO-Link, the display will immediately enter energy-saving mode.

7.8 Access rights

7.8.1 Write protection for the menu using a PIN code

A PIN code can be used to prevent the parameters from being changed from the user menu. It is still possible to display the current settings. When delivered, the PIN code is 0000 and a lock is therefore not active.

To activate the write protection, a PIN code between 001 and 999 must be entered via the menu or IO-link.

If write protection is activated using a customer-specific PIN code, the PIN code will then be request when attempting to change a parameter in the menu. When it is entered correctly, all of the parameter in the menu can be changed. The PIN lock is activated again automatically when no button has been pressed for one minute.

See also [chapter 6.1.4](#)



The status of signal inputs and outputs can be amended using parameter settings in ongoing operation. We recommend using a PIN code.

7.8.2 PIN code for NFC write protection

The writing of changed parameters via NFC can also be controlled using a separate PIN code. When delivered, the PIN code is 0000 and a lock is therefore not active. The NFC PIN code can be changed using IO-link.

When a PIN code is set between 001 and 999, the valid PIN must be entered for every subsequent write process using a mobile NFC device so that the switch accepts the changes.

7.8.3 IO-Link Device Access Locks

The “Device Access Locks” default parameter defined by the IO-link is available in the switch to prevent changes to parameter values using the user menu or IO-Link.

You can also prevent the use of the data storage mechanism described in IO-Link Standard V1.1.

Coding for the Device Access Locks

Bit	Meaning
0	Parameter write access locked (Parameters cannot be changed via IO-Link)
1	Data storage locked (Data storage mechanism is not triggered)
2	Local parametrization locked (Parameters cannot be changed via the user menu)



An existing menu lock using the Device Access Locks parameter will be retained in SIO operating mode. It can only be canceled using IO-Link, not in the menu itself.



The menu lock using the extended device access locks parameter has a higher priority than the menu PIN. That means that this lock also cannot be bypassed by entering a PIN.

7.8.4 Extended Device Access Locks

In the extended device access locks parameter, there is the possibility to completely prevent NFC access or limit it to read-only function:

Coding for the Extended Device Access Locks	
Bit	Meaning
0	NFC write locked (Parameters cannot be changed via NFC)
1	NFC disabled (NFC tag completely switched off)



The NFC lock using the extended device access locks parameter has a higher priority than the NFC PIN. That means that this lock also cannot be bypassed by entering a PIN.

7.9 Device identification

7.9.1 Device identity

The IO-link protocol provides a range of identification data for compliant devices that can be used to uniquely identify a device copy. The switches in the VSi ranges also include additional identification parameters.

All of these parameters are ASCII character strings that adapt their length to the relevant content.

The following can be queried:

- Manufacturer's name and website
- Product range and exact type name
- Part number and development status
- Serial number and date code
- Version status of the hardware and firmware



All character strings are available via the IO-link and NFC; only part numbers, serial numbers and the firmware revision can be retrieved from the menu.

7.9.2 User-specific localization

The following parameters are available when saving user-specific information in every individual copy of the VSi switch.

- Identification of the installation location
- Identification of the storage location
- Identification of the device tags on the circuit diagram
- Installation date
- Geo-location
- Web link to the relevant IODD



The mentioned parameters are ASCII character strings with the maximum length given in the data dictionary. They can also be used for other purposes if necessary.

The “NFC web link” parameter is a special feature. This parameter must include a valid web address beginning with `http://` or `https://` and is automatically used as a web address for NFC read accesses. As a result, read accesses from smart phones or tablets are rerouted e.g. to an address in the company's own intranet or a local server.

7.10 System monitoring and diagnostics

7.10.1 Minimum and maximum values

The maximum and minimum pressure/vacuum and operating voltage values that were measured since the last switch-on are logged by the switch and can be queried.

The maximum and minimum values can be reset via IO-link or NFC during operation using the appropriate system commands. This is also possible for pressure/vacuum via the operating menu under EF/rHL.

7.10.2 Counters

The switch has two internal, non-erasable cc1 and cc2 counters as well as two erasable ct1 and ct2 counters. These counters count the positive switching ramps of the switching points 1 and 2:

Symbol	Function	Description
cc1	Counter 1	Counter position, switching ramp SP1 (non-erasable):
cc2	Counter 2	Counter position, switching ramp SP2 (non-erasable):
ct1	Counter 3	Counter position, switching ramp SP1 (erasable):
ct2	Counter 4	Counter position, switching ramp SP2 (erasable):

The erasable ct1 and ct2 counters can be reset to 0 during operation via IO-link or NFC using the appropriate system commands. This is also possible in the operating menu via the EF/rct menu item.



The non-volatile storage of the counter statuses only occurs every 500 steps. That means that when the operating voltage is switched off, up to 499 steps of the counter are lost.

7.10.3 Status signals

The current status of the switch, i.e. whether errors or warnings are active, can be queried in various ways:

- Using the standard “device status,” “detailed device status” and “error count” IO-link parameters
- Using the “active error code” and “condition monitoring” parameter, as they are known by Schmalz vacuum ejectors.
- Using the “extended device status,” which transmits the entire display of the device status with classification of the severity level of errors and warnings.

7.10.4 Leakage measurement

If one of the switching points for the switch is set to condition monitoring mode, the actual leakage measured can be read in millibars per second.

7.11 System commands

7.11.1 Resetting to factory settings

All settings parameters for the switch are reset to factory settings using this function. Counter statuses, the zero-point adjustment of the sensor and the maximum and minimum values of the measurements are not affected by this function.

The standard factory settings for the switch versions can be found in [chapter 3.4](#).

7.11.2 Zero-point adjustment of the sensor (calibration)

Since the internally integrated sensor is subject to production-related fluctuations, we recommend calibrating the sensor once it is installed in the switch.

The pneumatic connection of the switch must be ventilated for zero-point adjustment of the sensor.



A zero offset is only possible by a maximum of $\pm 3\%$ (FS) around the theoretical zero position.



When the permissible limit is exceeded by $\pm 3\%$, error code E03 will appear in the display.

8 Troubleshooting

Fault	Possible cause	Solution
Master or peripheral power supply disturbed	IO-Link master connected with IO-Link Class-B port	Connect with IO-Link Class A Port
No output signal	Incorrect electrical connection	Check electrical connection and pin assignment
	Transistor function (PNP/NPN) not appropriate for the application	Adjust the transistor function (PNP/NPN) to the device's electrics.
	Switching logic inverted	Adjust the NO/NC switching point logic
No IO-link communication	Incorrect electrical connection	Check electrical connection and pin assignment
	Master not correctly configured	Check configuration of the master for whether the port is set to IO-link
No NFC communication	NFC connection between switch and reader (e.g. cell phone) not clean	Hold the reader at the intended position on the switch
	NFC function on reader (e.g. cell phone) not activated	Activate the NFC function on the reader (e.g. cell phone)
	NFC via IO-link deactivated	Activate NFC function
	Write operation canceled	Hold the reader at the intended position on the switch for longer
No parameters can be changed using NFC	PIN for NFC write protection activated via IO-link	Release of the NFC write permissions via IO-link
No display on the screen (VSi...D)	Eco mode activated	Press button or deactivate eco mode
	Incorrect electrical connection	Check electrical connection and pin assignment
Error number displayed	See next chapter	See next chapter
Warning message "Leakage too high" although handling cycle is working optimally	Limit value L-x (permissible leakage per second) set too low	Determine typical leakage values in a good handling cycle and set as limit value
	Threshold values SPx and rPx for leakage measurement set too low.	Set thresholds in such a way that there is a clear differentiation between the neutral and suction system statuses.
Warning message "Leakage too high" does not appear although there is high leakage in the system	Limit value L-x (permissible leakage per second) set too high.	Determine typical leakage values in a good handling cycle and set as limit value
	Threshold values SPx and rPx for leakage measurement set too high.	Set thresholds in such a way that there is a clear differentiation between the neutral and suction system statuses.

8.1 List of error numbers

When a known error occurs, this is reported in the form of an error number. An “E” followed by the error number appears in the screen of the display version. Additional error explanations and system statuses are available via IO-link and NFC (see [chapter 7.10.3](#). Status signals).



The system status is automatically refreshed on the NFC tag every 5 minutes at the latest. That means that an error may be displayed via NFC even though it has already disappeared.

Code	Fault	Possible cause	Solution
E01	Data error	Operating voltage was disconnected too quickly after changing the parameters, Saving process was not complete	Reset to factory settings Recording of a valid data set via IO-link (with engineering tool)
E03	CAL error	CAL was canceled when measurement value was too high or too low	Vent pneumatic connection before CAL is carried out
E07	Under voltage US	Supply voltage is too low	Check power supply and power load
E08	Communication canceled	IO-link communication canceled without explicit “fallback” from master	Check cabling for the master
E11	Short-circuit/ Overload OUT1	Power load too high, Short-circuit	Check cabling and power consumption for the connected consumers
E12	Short-circuit/ Overload OUT2	Power load too high, Short-circuit	Check cabling and power consumption for the connected consumers
E17	Over voltage US	Supply voltage is too high	Check power supply
E19	Overheating	Ambient temperature too high, Output continuous load too high	Ensure ventilation/cooling, check the power consumption of the connected consumers
E20	Teach-in error	Teach-in was carried out with an invalid measurement value (FFF/-FF), Teach-in for leakage mode was carried out with existing pressure	Measurement value must be in the valid measurement range for the VSi version Ensure that the measurement value is in the vacuum range in V8 leakage mode

9 Maintenance and cleaning



The switch does not require maintenance.

9.1 Cleaning the switch

CAUTION	
	<p>Cleaning the switch when voltage and/or compressed air is applied</p> <p>Personal injury and/or damage to property</p> <ul style="list-style-type: none"> ▶ Disconnect the switch completely from the supply lines ▶ Secure the machine / plant / system so that it cannot be switched on again

- Remove dirt on the exterior of the device with a soft cloth and soap suds (max. 60°C). Ensure that the switch is not soaked with soap suds.
- Ensure that no moisture can reach the electrical connection.
- Never use abrasive cleaning agents such as industrial alcohol, white spirit or thinners. Use pH 7-12 cleaning agent.

9.2 Decommissioning

After being replaced or after final decommissioning, the switch is to be disposed of in accordance with country-specific regulations.

CAUTION	
	<p>Incorrect disposal of the switch</p> <p>Environmental damage</p> <ul style="list-style-type: none"> ▶ Disposal according to country-specific regulations

10 Accessories

Type	Designation	Description	Part no.
Mounting kit	BEF-WIN 21x34.5x59 1.5	Metal bracket for simple switch attachment; incl. nut G1/8"	10.06.02.00061
VSi... connecting cable	ASK B-M8-4 5000 PUR GE	M8-4 female connector, cable end open	10.06.02.00031
VSi... connecting cable	ASK B-M12-4 5000 PUR GE	M12-4 female connector, cable end open	21.04.05.00263
VSi... connecting cable	ASK-S B-M8-4 5000 M12-4 PUR	M8-4 female connector with M12-4 plug	21.04.05.00264
VSi... connecting cable	ASK-S B-M12-4 5000 M12-4 PUR	M12-4 female connector with M12-4 plug	21.04.05.00265
Screw-in tool	MONT-VORR MON VS	Screw-in aid for quick assembly with cordless screwdriver	10.06.02.00615

11 Warranty

This system is guaranteed in accordance with our general terms of trade and delivery. The same applies to spare parts, provided that these are original parts supplied by us.
We are not liable for any damage resulting from the use of non-original spare parts or accessories.

12 Conformity Declaration

DE EU-Konformitätserklärung
 EN EC- Declaration of Conformity
 FR CE-Déclaration de conformité
 ES Certificado de conformidad CE
 IT Dichiarazione di conformità CE
 NL CE Conformiteitsverklaring



Hersteller / Manufacturer / Fabricant / Fabricante / Produttore / Fabrikant
 J. Schmalz GmbH, Aacher-Str. 29, D - 72293 Glatten

Produktbezeichnung / Product name / Designation du produit / Denominación del producto / Denominazione del prodotto /
 Beschrijving van de machine

Vakuum-/Druckschalter Serien / Vacuum-/pressure switch series / Vacuo-/pressostats Séries/
 Vacue-/Presostatos Serie / Vacuo-/pressostato Serie / Vacuüm-/drukschakelaar Serie

VSi...
 VSi...D
 VS...SA...

Erfüllte einschlägige EG-Richtlinien / Applicable EC directives met / Directives CE applicables respectées / Directivas vigentes de la CE cumplidas /
 Direttive CE applicate ed osservate / Nagekomen betreffende EG-richtlijnen

2014/30/EU Elektromagnetische Verträglichkeit / Electromagnetic Compatibility / Compatibilité électromagnétique / Compatibilidad
 electromagnética / Compatibilità elettromagnetica / Elektromagnetische compatibiliteit

Angewendete harmonisierte Normen / Harmonised standards applied / Normes d'harmonisation appliquées / Normas armonizadas aplicadas / Norme
 armonizzate adottate / Toegepaste geharmoniseerde normen

EN ISO 12100 Sicherheit von Maschinen - Grundbegriffe, allgemeine Gestaltungsleitsätze – Risikobeurteilung und Risikominderung /
 Safety of Machinery - Basic concepts, general principles for design – Risk assessment and risk reduction / Sécurité des machines -
 Notions fondamentales, principes généraux de conception - Appréciation du risque / Seguridad de máquinas - Conceptos básicos,
 principios generales de diseño – Estimación del riesgo / Sicurezza delle macchine - concetti fondamentali, principi generali della
 progettazione – Valutazione dei rischi / Veiligheid van machines - basisbegrippen, algemene eisen voor het ontwerp en de
 constructie – Risicobeoordeling

EN 61000-6-2 Elektromagnetische Verträglichkeit - Störfestigkeit / Electromagnetic Compatibility – Immunity / Compatibilité électromagnétique –
 Immunité / Compatibilidad electromagnética – Resistencia a interferencias / Compatibilità elettromagnetica – Immunità /
 Elektromagnetische compatibiliteit – immuniteit

EN 61000-6-4 Elektromagnetische Verträglichkeit - Störaussendung / Electromagnetic Compatibility – Emission / Compatibilité électromagnétique
 – Norme sur l'émission / Compatibilidad electromagnética – Emisión de interferencias / Compatibilità elettromagnetica – Norma
 generica sull'emissione / Elektromagnetische compatibiliteit – emissie

Dokumentationsverantwortlicher / Person responsible for documentation / Responsable de la documentation / Responsable de documentación /
 Responsabile della documentazione / Verantwoordelijk voor de documentatie

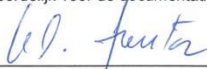
Glatten, 11.04.2016 / i.A. 
 Klaus-Dieter Fanta / J. Schmalz GmbH, Aacher-Str. 29, D - 72293 Glatten

Unterschrift, Angaben zum Unterzeichner / Signature, details of signatory / Signature, indications sur le soussigné / Firma y datos del firmante / Firma,
 dati concernenti il firmatario / Handtekening, omschrijving van de ondertekenaar

Glatten, 11.4.2016 / 
 Walter Dunkmann
 Leiter Geschäftsentwicklung, Vakuum-Komponenten /
 Head of Business Development, Vacuum Components



Schmalz Services



Kontakt weltweit

Unser Vertriebsnetz mit lokalen Außendienstmitarbeitern, internationalen Niederlassungen und Handelspartnern garantiert schnelle und kompetente Auskunft und Beratung in über 50 Ländern weltweit.

 www.schmalz.com/vertriebsnetz



Dokumentationen online

Laden Sie Kataloge, Bedienungsanleitungen und CAD-Daten bequem online herunter und informieren Sie sich umfassend über unsere Produkte und Dienstleistungen.

 www.schmalz.com/dokumentationen



„Gewusst wie...?“ Videos

In den kurzen Videobeiträgen erklären wir einfach und verständlich die umfangreichen Funktionen, die in unseren Produkten stecken. Einfach reinschauen, es lohnt sich!

 www.schmalz.com/gewusst-wie

Weitere Serviceleistungen von Beratung bis Schulung finden Sie unter

 www.schmalz.com/services